

**nano line series**

**Luci nano line**



**Luci nano line 109**

**Luci Pte., Ltd.**

2016.08.22

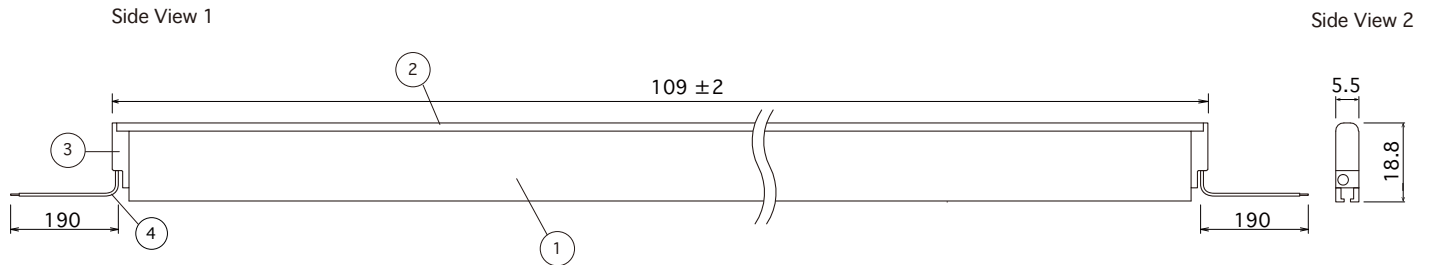

**Option parts:**  
**Mounting Clip A for nano line :**  
 (LNL-PTA) (Accessories : 2 parts for the body installation, and 2 parts for the end part installation,  
 Option parts : 4 parts for the body installation, and 4 parts for the end part installation)

Installation Dimensions  
 (Side View)

**Option parts:**  
**Magnet for nano line**  
 (LNL-MG) (10pcs / 1bag)

Installation Dimensions  
 (Side View)

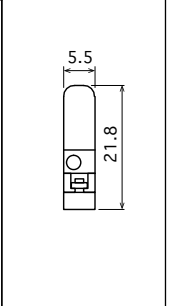
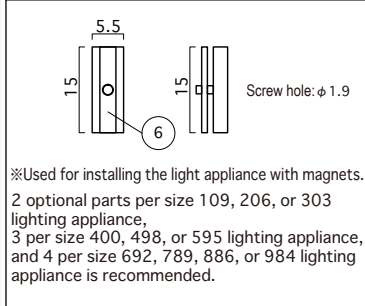
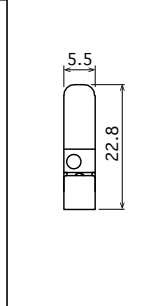
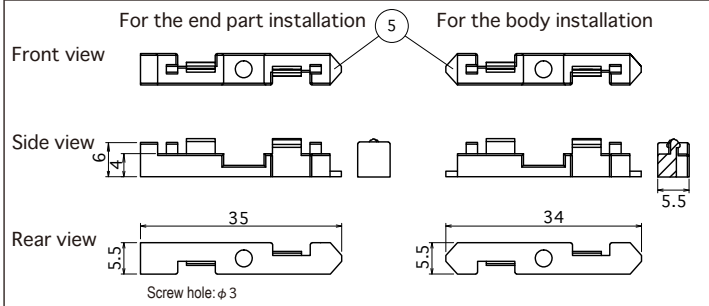

Part Name	Material	Note	Drawing
1 Body	Aluminum, alumite treatment	Silver	
2 Body Cover	Polycarbonate	Diffuser	
3 Side cover	Polycarbonate	Diffuser	
4 Lead wire		UL1007 AWG26, black+, white-	
5 Mounting Clip A	PC (Polycarbonate)	Clear	
6 Magnet	Stainless steel, Neodymium	Plate, Magnet	
7			
8			
9			
10			

Spec	Item Number
Input voltage : DC24V	LNL-0109-N-DF-I LNL-0109-W-DF-I LNL-0109-WW-DF-I LNL-0109-L30-DF-I LNL-0109-L27-DF-I LNL-0109-L24-DF-I
Power consumption : 0.7W	
Weight : 20g	
Lamp fitting length(L) : 109mm	
Max. sets connectable : 5m	
Environment : Indoors (No Condensation)	
Attachments : Mounting Clip A (2 parts for the body installation, and 2 parts for the end part installation.)	
Option parts : Mounting Clip A, Magnet	
Light Source color : Natural white : N : 5300K ( -- lm* / Ra -- )	
White : W : 4200K ( 7 lm* / Ra 92 )	
Warm white : WW : 3500K ( 6 lm* / Ra 91 )	
Warm white 3000K : L30 : 3000K ( 7 lm* / Ra 87 )	
Warm white 2700K : L27 : 2700K ( 6 lm* / Ra 87 )	
Warm white 2400K : L24 : 2400K ( 5 lm* / Ra 85 )	
*=Equivalent	

Job/Project Name	Area/Location/Circuit No.
Product Code	Qty. Length(mm)

**Luci nano line 206**

**Luci Pte., Ltd.**

2016.08.22

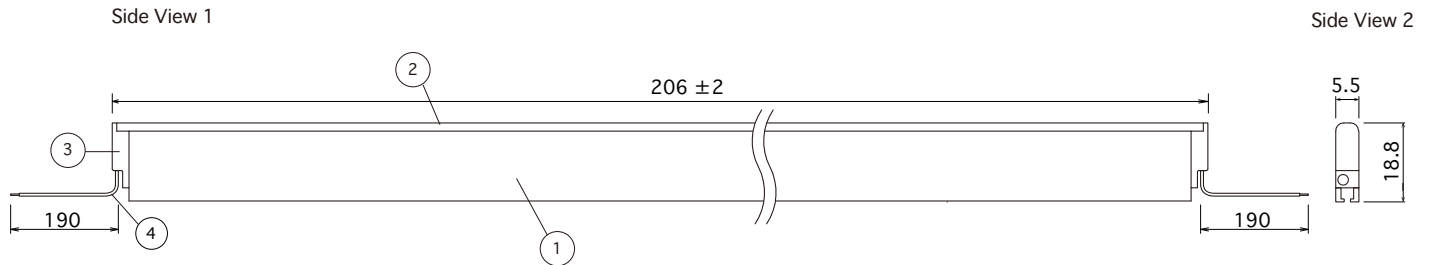

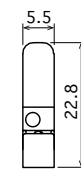
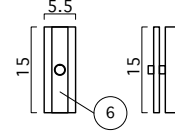
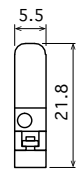
<p><b>Option parts:</b> Mounting Clip A for nano line : (LNL-PTA) (Accessories : 2 parts for the body installation, and 2 parts for the end part installation, Option parts : 4 parts for the body installation, and 4 parts for the end part installation)</p>	<p>Installation Dimensions (Side View)</p>	<p><b>Option parts:</b> Magnet for nano line (LNL-MG) (10pcs / 1bag)</p>	<p>Installation Dimensions (Side View)</p>
<p>For the end part installation (5) For the body installation</p> <p>Front view</p> <p>Side view</p> <p>Rear view</p> <p>Screw hole: <math>\phi 3</math></p>		 <p>Screw hole: <math>\phi 1.9</math></p> <p>※Used for installing the light appliance with magnets. 2 optional parts per size 109, 206, or 303 lighting appliance, 3 per size 400, 498, or 595 lighting appliance, and 4 per size 692, 789, 886, or 984 lighting appliance is recommended.</p>	

Part Name	Material	Note	Drawing
1 Body	Aluminum, alumite treatment	Silver	
2 Body Cover	Polycarbonate	Diffuser	
3 Side cover	Polycarbonate	Diffuser	
4 Lead wire		UL1007 AWG26, black+, white-	
5 Mounting Clip A	PC (Polycarbonate)	Clear	
6 Magnet	Stainless steel, Neodymium	Plate, Magnet	
7			
8			
9			
10			

<p><b>Spec</b> Input voltage : DC24V</p> <p>Power consumption : 1.4W</p> <p>Weight : 37g</p> <p>Lamp fitting length(L) : 206mm</p> <p>Max. sets connectable : 5m</p> <p>Environment : Indoors (No Condensation)</p> <p>Attachments : Mounting Clip A (2 parts for the body installation, and 2 parts for the end part installation.)</p> <p>Option parts : Mounting Clip A, Magnet</p>	<p>Light Source color : Natural white : N : 5300K (— lm/ Ra —)</p> <p>White : W : 4200K (13 lm*/ Ra 92)</p> <p>Warm white : WW : 3500K (12 lm*/ Ra 91)</p> <p>Warm white 3000K : L30 : 3000K (13 lm*/ Ra 87)</p> <p>Warm white 2700K : L27 : 2700K (12 lm*/ Ra 87)</p> <p>Warm white 2400K : L24 : 2400K (10 lm*/ Ra 85)</p> <p>*=Equivalent</p>	<p><b>Item Number</b></p> <p>LNL-0206-N-DF-I</p> <p>LNL-0206-W-DF-I</p> <p>LNL-0206-WW-DF-I</p> <p>LNL-0206-L30-DF-I</p> <p>LNL-0206-L27-DF-I</p> <p>LNL-0206-L24-DF-I</p>
--	--	--

Job/Project Name	Area/Location/Circuit No.
Product Code	Qty. Length(mm)

**nano line series**

**Luci nano line**

**Luci nano line 303**



**Luci Pte., Ltd.**

2016.08.22

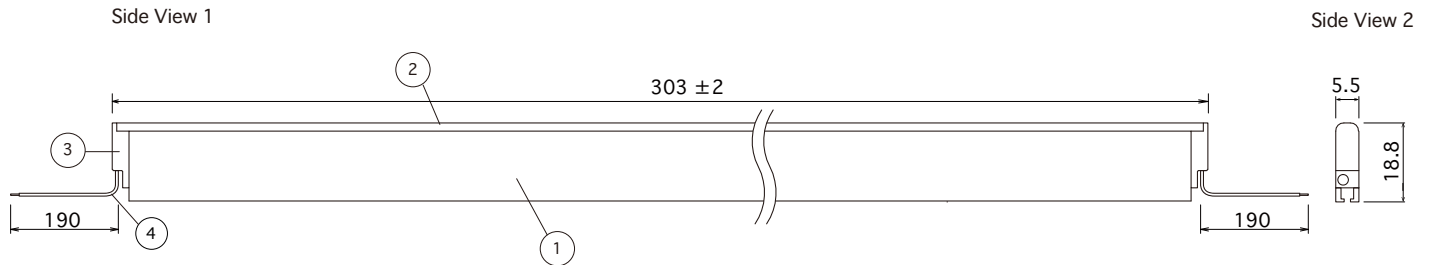

Option parts:  
Mounting Clip A for nano line :  
(LNL-PTA) (Accessories : 2 parts for the body installation, and 2 parts for the end part installation,  
Option parts : 4 parts for the body installation, and 4 parts for the end part installation)

Installation Dimensions  
(Side View)

Option parts:  
Magnet for nano line  
(LNL-MG) (10pcs / 1bag)

Installation Dimensions  
(Side View)

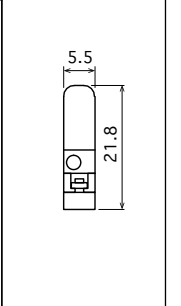
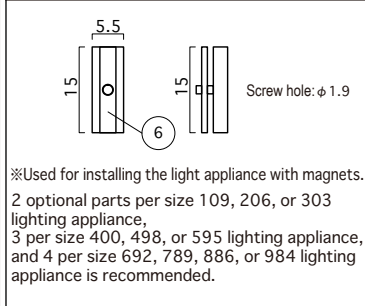
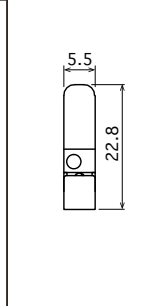
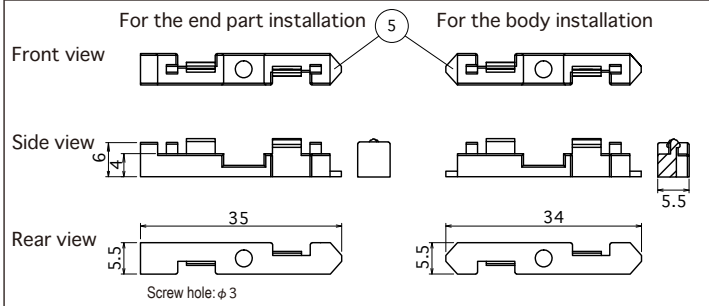



Part Name	Material	Note	Drawing
1 Body	Aluminum, alumite treatment	Silver	
2 Body Cover	Polycarbonate	Diffuser	
3 Side cover	Polycarbonate	Diffuser	
4 Lead wire		UL1007 AWG26, black+, white-	
5 Mounting Clip A	PC (Polycarbonate)	Clear	
6 Magnet	Stainless steel, Neodymium	Plate, Magnet	
7			
8			
9			
10			

Spec	Item Number
Input voltage : DC24V	LNL-0303-N-DF-I LNL-0303-W-DF-I LNL-0303-WW-DF-I LNL-0303-L30-DF-I LNL-0303-L27-DF-I LNL-0303-L24-DF-I
Power consumption : 2.2W	
Weight : 52g	
Lamp fitting length(L) : 303mm	
Max. sets connectable : 5m	
Environment : Indoors (No Condensation)	
Attachments : Mounting Clip A (2 parts for the body installation, and 2 parts for the end part installation.)	
Option parts : Mounting Clip A, Magnet	
Light Source color : Natural white : N : 5300K (— lm/ Ra —)	
White : W : 4200K (20 lm*/ Ra 92)	
Warm white : WW : 3500K (17 lm*/ Ra 91)	
Warm white 3000K : L30 : 3000K (20 lm*/ Ra 87)	
Warm white 2700K : L27 : 2700K (18 lm*/ Ra 87)	
Warm white 2400K : L24 : 2400K (16 lm*/ Ra 85)	
*=Equivalent	

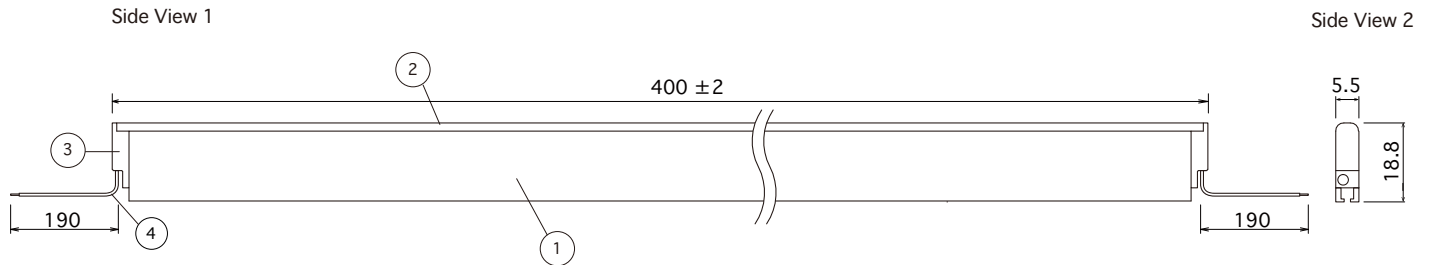
Job/Project Name	Area/Location/Circuit No.
Product Code	Qty. Length(mm)

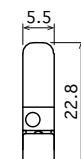
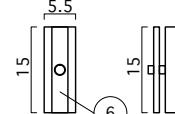
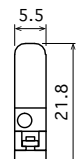

<p><b>Option parts:</b> Mounting Clip A for nano line : (LNL-PTA) (Accessories : 2 parts for the body installation, and 2 parts for the end part installation, Option parts : 4 parts for the body installation, and 4 parts for the end part installation)</p> <p>For the end part installation (5) For the body installation</p> <p>Front view</p> <p>Side view</p> <p>Rear view</p> <p>Screw hole: <math>\phi 3</math></p>	<p>Installation Dimensions (Side View)</p> 	<p><b>Option parts:</b> Magnet for nano line (LNL-MG) (10pcs / 1bag)</p>  <p>Screw hole: <math>\phi 1.9</math></p> <p>※Used for installing the light appliance with magnets. 2 optional parts per size 109, 206, or 303 lighting appliance, 3 per size 400, 498, or 595 lighting appliance, and 4 per size 692, 789, 886, or 984 lighting appliance is recommended.</p>	<p>Installation Dimensions (Side View)</p> 
---	---	---	---

Part Name	Material	Note	Drawing
1 Body	Aluminum, alumite treatment	Silver	
2 Body Cover	Polycarbonate	Diffuser	
3 Side cover	Polycarbonate	Diffuser	
4 Lead wire		UL1007 AWG26, black+, white-	
5 Mounting Clip A	PC (Polycarbonate)	Clear	
6 Magnet	Stainless steel, Neodymium	Plate, Magnet	
7			
8			
9			
10			

<p><b>Spec</b> Input voltage : DC24V</p> <p>Power consumption : 2.9W</p> <p>Weight : 68g</p> <p>Lamp fitting length(L) : 400mm</p> <p>Max. sets connectable : 5m</p> <p>Environment : Indoors (No Condensation)</p> <p>Attachments : Mounting Clip A (2 parts for the body installation, and 2 parts for the end part installation.)</p> <p>Option parts : Mounting Clip A, Magnet</p>	<p>Light Source color : Natural white : N : 5300K (— lm/ Ra —)</p> <p>White : W : 4200K (26 lm*/ Ra 92)</p> <p>Warm white : WW : 3500K (23 lm*/ Ra 91)</p> <p>Warm white 3000K : L30 : 3000K (26 lm*/ Ra 87)</p> <p>Warm white 2700K : L27 : 2700K (24 lm*/ Ra 87)</p> <p>Warm white 2400K : L24 : 2400K (21 lm*/ Ra 85)</p> <p>*=Equivalent</p>	<p><b>Item Number</b></p> <p>LNL-0400-N-DF-I</p> <p>LNL-0400-W-DF-I</p> <p>LNL-0400-WW-DF-I</p> <p>LNL-0400-L30-DF-I</p> <p>LNL-0400-L27-DF-I</p> <p>LNL-0400-L24-DF-I</p>
--	--	--

Job/Project Name	Area/Location/Circuit No.
Product Code	Qty. Length(mm)

**nano line series**

**Luci nano line**



**Luci nano line 498**

**Luci Pte., Ltd.**

2016.08.22

Side View 1

Side View 2

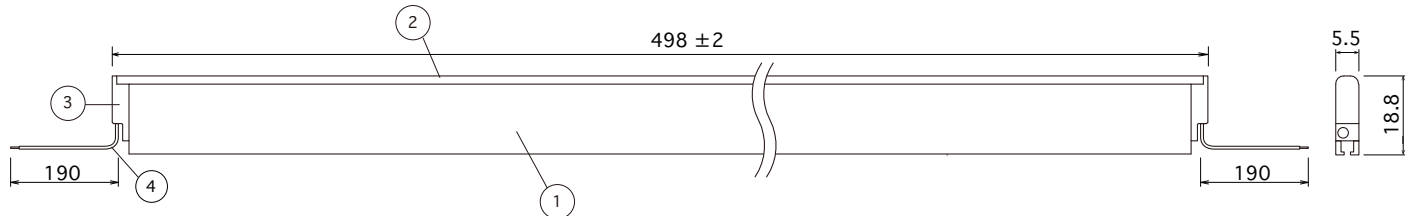

Option parts:  
Mounting Clip A for nano line :  
(LNL-PTA) (Accessories : 2 parts for the body installation, and 2 parts for the end part installation,  
Option parts : 4 parts for the body installation, and 4 parts for the end part installation)

Installation Dimensions  
(Side View)

Option parts:  
Magnet for nano line  
(LNL-MG) (10pcs / 1bag)

Installation Dimensions  
(Side View)

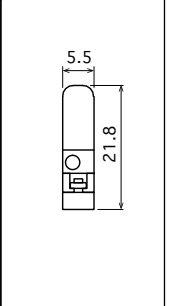
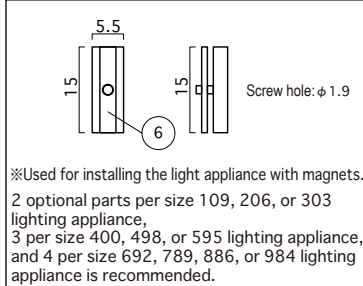
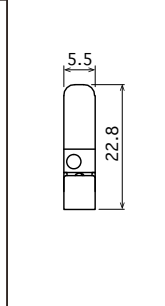
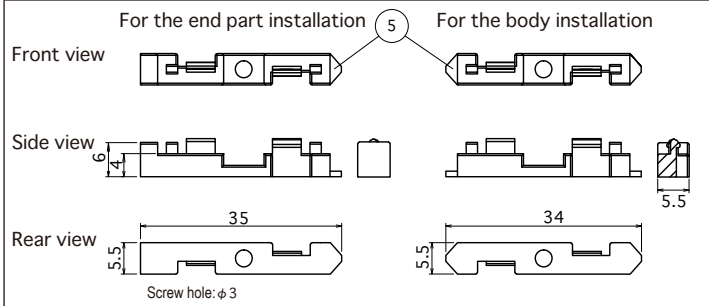

Part Name	Material	Note	Drawing
1 Body	Aluminum, alumite treatment	Silver	
2 Body Cover	Polycarbonate	Diffuser	
3 Side cover	Polycarbonate	Diffuser	
4 Lead wire		UL1007 AWG26, black+, white-	
5 Mounting Clip A	PC (Polycarbonate)	Clear	
6 Magnet	Stainless steel, Neodymium	Plate, Magnet	
7			
8			
9			
10			

Spec	Item Number
Input voltage : DC24V	LNL-0498-N-DF-I LNL-0498-W-DF-I LNL-0498-WW-DF-I LNL-0498-L30-DF-I LNL-0498-L27-DF-I LNL-0498-L24-DF-I
Power consumption : 3.6W	
Weight : 83g	
Lamp fitting length(L) : 498mm	
Max. sets connectable : 5m	
Environment : Indoors (No Condensation)	
Attachments : Mounting Clip A (2 parts for the body installation, and 2 parts for the end part installation.)	
Option parts : Mounting Clip A, Magnet	

Job/Project Name	Area/Location/Circuit No.
Product Code	Qty. Length(mm)

**nano line series**

**Luci nano line**

Luci nano line 595



Luci Pte., Ltd.

2016.08.22

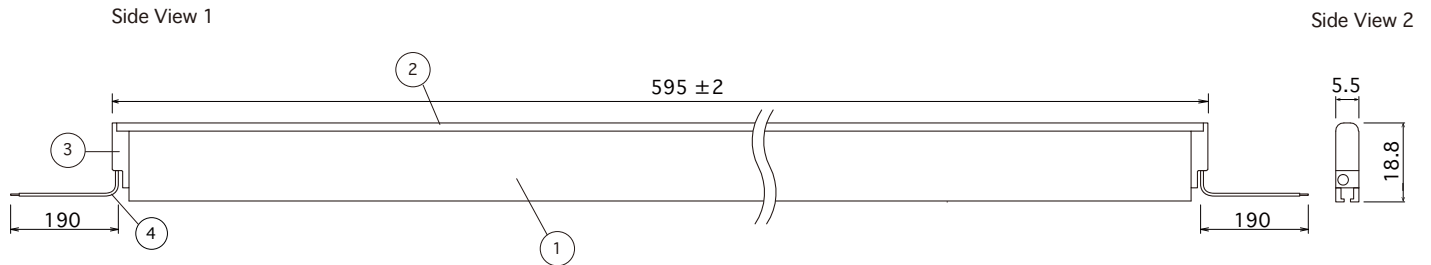

<p><b>Option parts:</b> Mounting Clip A for nano line : (LNL-PTA) (Accessories : 2 parts for the body installation, and 2 parts for the end part installation, Option parts : 4 parts for the body installation, and 4 parts for the end part installation)</p> <p>For the end part installation (5) For the body installation</p> <p>Front view</p> <p>Side view</p> <p>Rear view</p> <p>Screw hole: <math>\phi 3</math></p>	<p>Installation Dimensions (Side View)</p>	<p><b>Option parts:</b> Magnet for nano line (LNL-MG) (10pcs / 1bag)</p> <p>※Used for installing the light appliance with magnets. 2 optional parts per size 109, 206, or 303 lighting appliance, 3 per size 400, 498, or 595 lighting appliance, and 4 per size 692, 789, 886, or 984 lighting appliance is recommended.</p>	<p>Installation Dimensions (Side View)</p>
---	--	---	--

Part Name	Material	Note	Drawing
1 Body	Aluminum, alumite treatment	Silver	
2 Body Cover	Polycarbonate	Diffuser	
3 Side cover	Polycarbonate	Diffuser	
4 Lead wire		UL1007 AWG26, black+, white-	
5 Mounting Clip A	PC (Polycarbonate)	Clear	
6 Magnet	Stainless steel, Neodymium	Plate, Magnet	
7			
8			
9			
10			

<p><b>Spec</b> Input voltage : DC24V</p> <p>Power consumption : 4.3W</p> <p>Weight : 99g</p> <p>Lamp fitting length(L) : 595mm</p> <p>Max. sets connectable : 5m</p> <p>Environment : Indoors (No Condensation)</p> <p>Attachments : Mounting Clip A (2 parts for the body installation, and 2 parts for the end part installation.)</p> <p>Option parts : Mounting Clip A, Magnet</p>	<p>Light Source color : Natural white : N : 5300K (— lm/ Ra —)</p> <p>White : W : 4200K (40 lm*/ Ra 92)</p> <p>Warm white : WW : 3500K (35 lm*/ Ra 91)</p> <p>Warm white 3000K : L30 : 3000K (39 lm*/ Ra 87)</p> <p>Warm white 2700K : L27 : 2700K (35 lm*/ Ra 87)</p> <p>Warm white 2400K : L24 : 2400K (31 lm*/ Ra 85)</p> <p>*=Equivalent</p>	<p><b>Item Number</b></p> <p>LNL-0595-N-DF-I</p> <p>LNL-0595-W-DF-I</p> <p>LNL-0595-WW-DF-I</p> <p>LNL-0595-L30-DF-I</p> <p>LNL-0595-L27-DF-I</p> <p>LNL-0595-L24-DF-I</p>
--	--	--

Job/Project Name	Area/Location/Circuit No.
Product Code	Qty. Length(mm)

**nano line series**

**Luci nano line**

**Luci nano line 692**



**Luci Pte., Ltd.**

2016.08.22

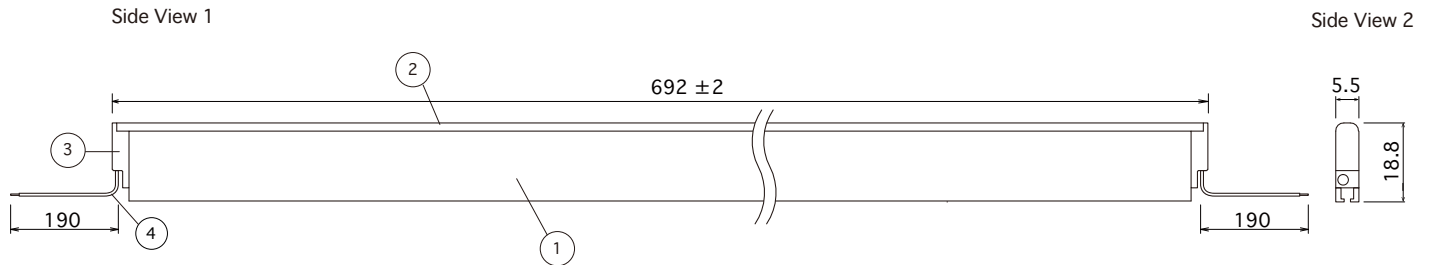

<p>Option parts: Mounting Clip A for nano line : (LNL-PTA) (Accessories : 2 parts for the body installation, and 2 parts for the end part installation, Option parts : 4 parts for the body installation, and 4 parts for the end part installation)</p>	<p>Installation Dimensions (Side View)</p>	<p>Option parts: Magnet for nano line (LNL-MG) (10pcs / 1bag)</p>	<p>Installation Dimensions (Side View)</p>
<p>For the end part installation (5) For the body installation</p> <p>Front view</p> <p>Side view</p> <p>Rear view</p> <p>Screw hole: <math>\phi 3</math></p>		<p>Screw hole: <math>\phi 1.9</math></p> <p>※Used for installing the light appliance with magnets. 2 optional parts per size 109, 206, or 303 lighting appliance, 3 per size 400, 498, or 595 lighting appliance, and 4 per size 692, 789, 886, or 984 lighting appliance is recommended.</p>	

Part Name	Material	Note	Drawing
1 Body	Aluminum, alumite treatment	Silver	
2 Body Cover	Polycarbonate	Diffuser	
3 Side cover	Polycarbonate	Diffuser	
4 Lead wire		UL1007 AWG26, black+, white-	
5 Mounting Clip A	PC (Polycarbonate)	Clear	
6 Magnet	Stainless steel, Neodymium	Plate, Magnet	
7			
8			
9			
10			

<p><b>Spec</b> Input voltage : DC24V</p> <p>Power consumption : 5.0W</p> <p>Weight : 114g</p> <p>Lamp fitting length(L) : 692mm</p> <p>Max. sets connectable : 5m</p> <p>Environment : Indoors (No Condensation)</p> <p>Attachments : Mounting Clip A (2 parts for the body installation, and 2 parts for the end part installation.)</p> <p>Option parts : Mounting Clip A, Magnet</p>	<p>Light Source color : Natural white : N : 5300K (— lm/ Ra —)</p> <p>White : W : 4200K (46 lm*/ Ra 92)</p> <p>Warm white : WW : 3500K (41 lm*/ Ra 91)</p> <p>Warm white 3000K : L30 : 3000K (46 lm*/ Ra 87)</p> <p>Warm white 2700K : L27 : 2700K (41 lm*/ Ra 87)</p> <p>Warm white 2400K : L24 : 2400K (36 lm*/ Ra 85)</p> <p>*=Equivalent</p>	<p><b>Item Number</b></p> <p>LNL-0692-N-DF-I</p> <p>LNL-0692-W-DF-I</p> <p>LNL-0692-WW-DF-I</p> <p>LNL-0692-L30-DF-I</p> <p>LNL-0692-L27-DF-I</p> <p>LNL-0692-L24-DF-I</p>
---	--	--

Job/Project Name	Area/Location/Circuit No.
Product Code	Qty. Length(mm)

**Luci nano line 789**

**Luci Pte., Ltd.**

2016.08.22

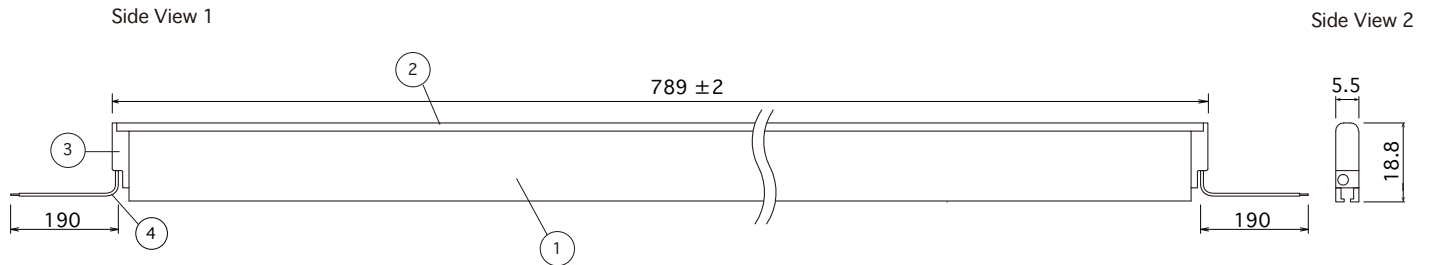

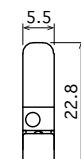
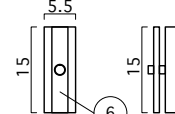
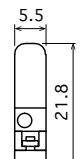
<p><b>Option parts:</b> Mounting Clip A for nano line : (LNL-PTA) (Accessories : 2 parts for the body installation, and 2 parts for the end part installation, Option parts : 4 parts for the body installation, and 4 parts for the end part installation)</p> <p>For the end part installation (5) For the body installation</p> <p>Front view</p> <p>Side view</p> <p>Rear view</p> <p>Screw hole: <math>\phi 3</math></p>	<p>Installation Dimensions (Side View)</p> 	<p><b>Option parts:</b> Magnet for nano line (LNL-MG) (10pcs / 1bag)</p>  <p>Screw hole: <math>\phi 1.9</math></p> <p>※Used for installing the light appliance with magnets. 2 optional parts per size 109, 206, or 303 lighting appliance, 3 per size 400, 498, or 595 lighting appliance, and 4 per size 692, 789, 886, or 984 lighting appliance is recommended.</p>	<p>Installation Dimensions (Side View)</p> 
---	---	---	---

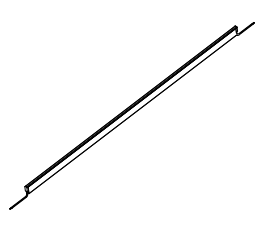
Part Name	Material	Note	Drawing
1 Body	Aluminum, alumite treatment	Silver	
2 Body Cover	Polycarbonate	Diffuser	
3 Side cover	Polycarbonate	Diffuser	
4 Lead wire		UL1007 AWG26, black+, white-	
5 Mounting Clip A	PC (Polycarbonate)	Clear	
6 Magnet	Stainless steel, Neodymium	Plate, Magnet	
7			
8			
9			
10			

<p><b>Spec</b> Input voltage : DC24V</p> <p>Power consumption : 5.8W</p> <p>Weight : 130g</p> <p>Lamp fitting length(L) : 789mm</p> <p>Max. sets connectable : 5m</p> <p>Environment : Indoors (No Condensation)</p> <p>Attachments : Mounting Clip A (2 parts for the body installation, and 2 parts for the end part installation.)</p> <p>Option parts : Mounting Clip A, Magnet</p>	<p>Light Source color : Natural white : N : 5300K (— lm/ Ra —)</p> <p>White : W : 4200K (53 lm*/ Ra 92)</p> <p>Warm white : WW : 3500K (46 lm*/ Ra 91)</p> <p>Warm white 3000K : L30 : 3000K (52 lm*/ Ra 87)</p> <p>Warm white 2700K : L27 : 2700K (47 lm*/ Ra 87)</p> <p>Warm white 2400K : L24 : 2400K (42 lm*/ Ra 85)</p> <p>*=Equivalent</p>	<p><b>Item Number</b></p> <p>LNL-0789-N-DF-I</p> <p>LNL-0789-W-DF-I</p> <p>LNL-0789-WW-DF-I</p> <p>LNL-0789-L30-DF-I</p> <p>LNL-0789-L27-DF-I</p> <p>LNL-0789-L24-DF-I</p>
---	--	--

Job/Project Name	Area/Location/Circuit No.
Product Code	Qty. Length(mm)



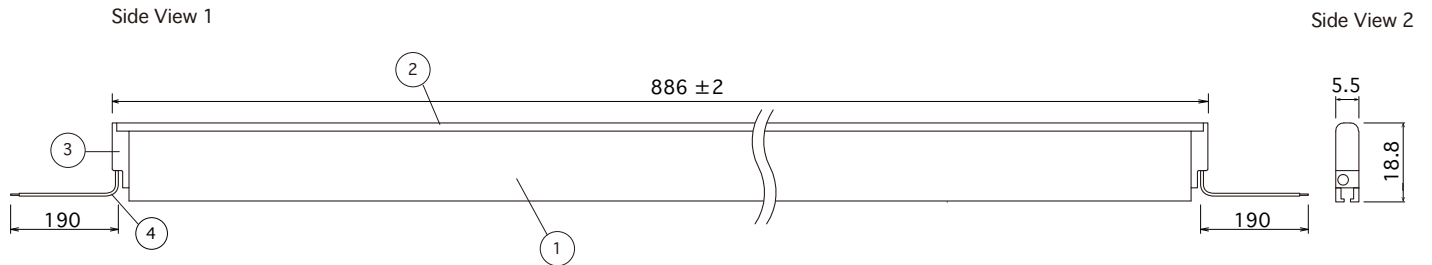

Option parts:  
Mounting Clip A for nano line :  
(LNL-PTA) (Accessories : 2 parts for the body installation, and 2 parts for the end part installation,  
Option parts : 4 parts for the body installation, and 4 parts for the end part installation)

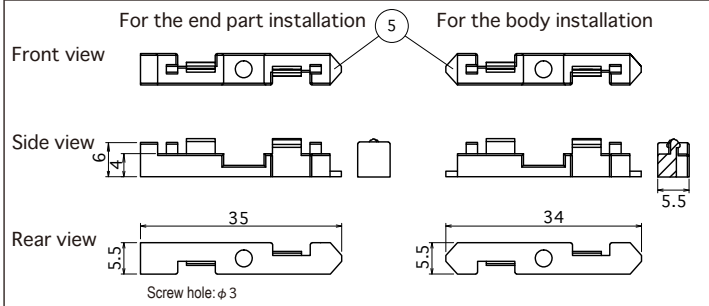

Installation Dimensions  
(Side View)



Option parts:  
Magnet for nano line  
(LNL-MG) (10pcs / 1bag)

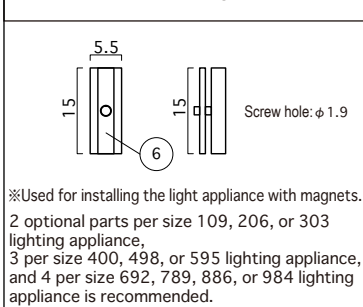

Installation Dimensions  
(Side View)

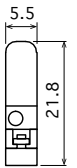

Part Name	Material	Note
1 Body	Aluminum, alumite treatment	Silver
2 Body Cover	Polycarbonate	Diffuser
3 Side cover	Polycarbonate	Diffuser
4 Lead wire		UL1007 AWG26, black+, white-
5 Mounting Clip A	PC (Polycarbonate)	Clear
6 Magnet	Stainless steel, Neodymium	Plate, Magnet
7		
8		
9		
10		

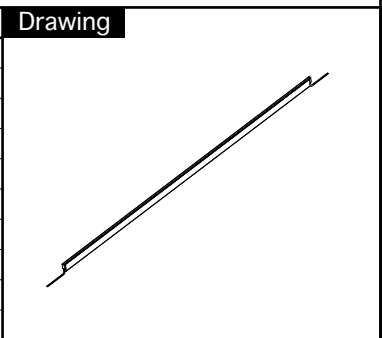

Spec	Item Number
Input voltage : DC24V	LNL-0886-N-DF-I LNL-0886-W-DF-I LNL-0886-WW-DF-I LNL-0886-L30-DF-I LNL-0886-L27-DF-I LNL-0886-L24-DF-I
Power consumption : 6.5W	
Weight : 145g	
Lamp fitting length(L) : 886mm	
Max. sets connectable : 5m	
Environment : Indoors (No Condensation)	
Attachments : Mounting Clip A (2 parts for the body installation, and 2 parts for the end part installation.)	
Option parts : Mounting Clip A, Magnet	
Light Source color : Natural white : N : 5300K (— lm/ Ra —)	
White : W : 4200K (59 lm* / Ra 92)	
Warm white : WW : 3500K (52 lm* / Ra 91)	
Warm white 3000K : L30 : 3000K (59 lm* / Ra 87)	
Warm white 2700K : L27 : 2700K (53 lm* / Ra 87)	
Warm white 2400K : L24 : 2400K (47 lm* / Ra 85)	
*=Equivalent	

Job/Project Name	Area/Location/Circuit No.
Product Code	Qty. Length(mm)

**nano line series**

**Luci nano line**

**Luci nano line 984**



**Luci Pte., Ltd.**

2016.08.22

Side View 1

Side View 2

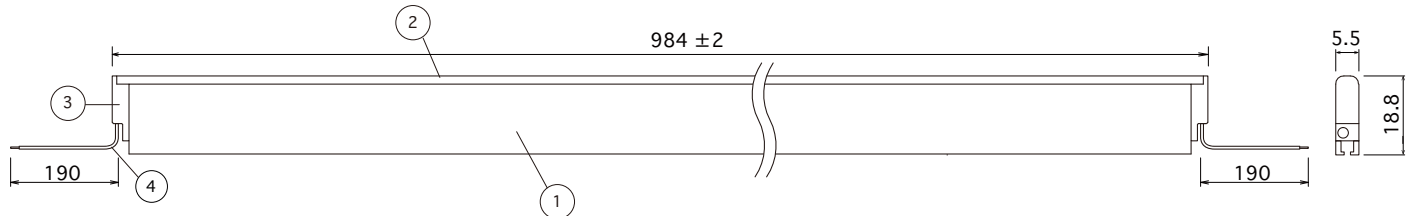

Option parts:  
Mounting Clip A for nano line :  
(LNL-PTA) (Accessories : 2 parts for the body installation, and 2 parts for the end part installation,  
Option parts : 4 parts for the body installation, and 4 parts for the end part installation)

Installation Dimensions  
(Side View)

Option parts:  
Magnet for nano line  
(LNL-MG) (10pcs / 1bag)

Installation Dimensions  
(Side View)

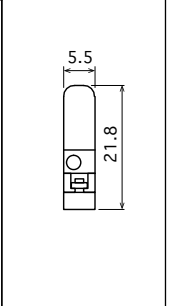
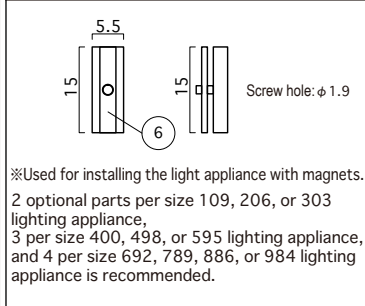
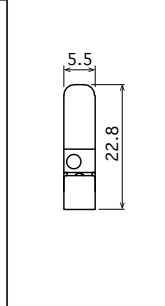
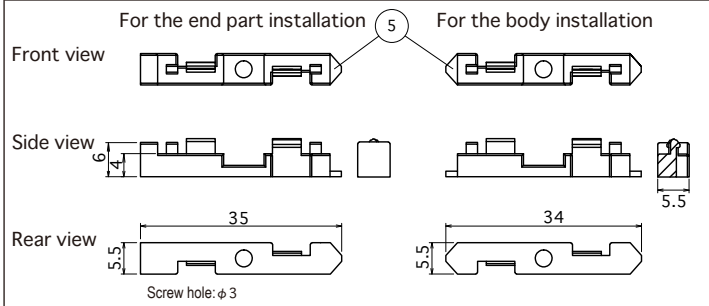

Part Name	Material	Note
1 Body	Aluminum, alumite treatment	Silver
2 Body Cover	Polycarbonate	Diffuser
3 Side cover	Polycarbonate	Diffuser
4 Lead wire		UL1007 AWG26, black+, white-
5 Mounting Clip A	PC (Polycarbonate)	Clear
6 Magnet	Stainless steel, Neodymium	Plate, Magnet
7		
8		
9		
10		

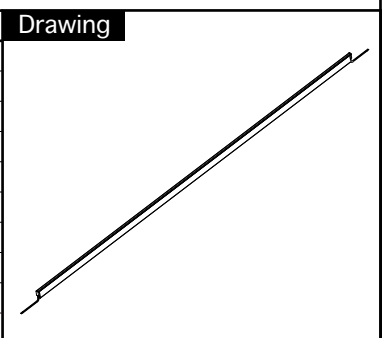

Spec	Item Number
Input voltage : DC24V	LNL-0984-N-DF-I LNL-0984-W-DF-I LNL-0984-WW-DF-I LNL-0984-L30-DF-I LNL-0984-L27-DF-I LNL-0984-L24-DF-I
Power consumption : 7.2W	
Weight : 160g	
Lamp fitting length(L) : 984mm	
Max. sets connectable : 5m	
Environment : Indoors (No Condensation)	
Attachments : Mounting Clip A (2 parts for the body installation, and 2 parts for the end part installation.)	
Option parts : Mounting Clip A, Magnet	
Light Source color : Natural white : N : 5300K (— lm/ Ra —)	
White : W : 4200K (66 lm/ Ra 92)	
Warm white : WW : 3500K (58 lm/ Ra 91)	
Warm white 3000K : L30 : 3000K (65 lm/ Ra 87)	
Warm white 2700K : L27 : 2700K (59 lm/ Ra 87)	
Warm white 2400K : L24 : 2400K (52 lm/ Ra 85)	
*=Equivalent	

Job/Project Name	Area/Location/Circuit No.
Product Code	Qty. Length(mm)