

**TWO STAGE GAS BURNERS**

▶ **RS SERIES**

▶ <b>RS 28</b>	81/163 ÷ 325 kW
▶ <b>RS 38</b>	105/232 ÷ 440 kW
▶ <b>RS 50</b>	116/290 ÷ 580 kW
▶ <b>RS 70</b>	192/465 ÷ 814 kW
▶ <b>RS 100</b>	232/698 ÷ 1163 kW
▶ <b>RS 130</b>	372/930 ÷ 1512 kW
▶ <b>RS 190</b>	470/1279 ÷ 2290 kW

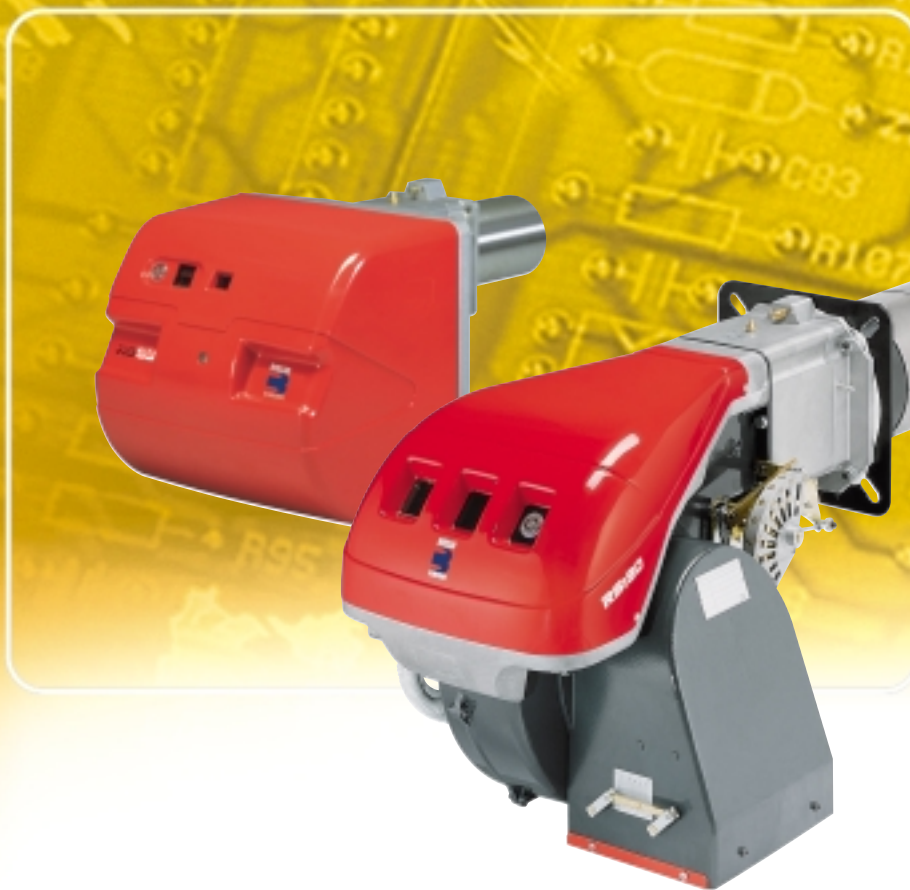

The RS series of burners covers a firing range from 81 to 2290 kW, and they have been designed for use in hot or superheater water boilers, hot air or steam generators, diathermic oil boilers.

Operation is "two stage"; the burners are fitted with an electronic device STATUS PANEL, which supplies complete diagnostic: hour meter, ignition meter, identification of trouble shooting.

Optimisation of sound emissions is guaranteed by the use of fans with forward inclined blades and sound deadening material incorporated in the air suction circuit.

The elevated performance of the fans and combustion head, guarantee flexibility of use and excellent working at all firing rates.

The exclusive design ensures reduced dimensions, simple use and maintenance. A wide range of accessories guarantees elevated working flexibility.



# TECHNICAL DATA

Model		▼ RS 28	▼ RS 38	▼ RS 38	▼ RS 50	▼ RS 70	▼ RS 100	▼ RS 130	▼ RS 190
Burner operation mode		Two stage							
Modulation ratio to max. output		2 ÷ 1							
Servo-motor	Type	SQN90			LKS210			SQN31	
	Run time	12			15			15	
Heat output	kW	81/163÷325	105/232÷440	105/232÷440	116/290÷581	192/465÷814	232/698÷1163	372/930÷1512	470/1279÷2290
	Mcal/h	70/140÷280	90/200÷378	90/200÷378	100/249÷500	165/400÷700	200/600÷1000	320/800÷1300	405/1100÷1970
Working temperature °C min./max.		0/40							
Net calorific value gas G20 kWh/Nmc		10							
Density gas G20 kg/Nmc		0,71							
Output gas G20 Nmc/h		8/16÷32	10,5/23÷44	10,5/23÷44	11,6/29÷58	19/46,5÷81,4	23/70÷116	37/93÷151	47/128÷229
Net calorific value gas G25 kWh/Nmc		8,6							
Density gas G25 kg/Nmc		0,78							
Output gas G25 Nmc/h		9,4/19÷38	12/27÷51	12/27÷51	13,5/34÷68	22/54÷95	27/81÷135	43/108÷176	55/149÷266
Net calorific value LPG gas kWh/Nmc		25,8							
Density LPG gas kg/Nmc		2,02							
Output LPG gas Nmc/h		3/6,5÷12,5	4/9÷17	4/9÷17	4,5/11÷23	7,4/18÷32	9/27÷45	14,4/36÷59	18/50÷89
Fan		Centrifugal with reverse curve blades							Straight blades
Air temperature Max. °C		60							
Electrical supply Ph/Hz/V		1/50/230-(±10%)			3N/50/230-400-(±10%)			3/50/230-(±10%)	
Auxiliary electrical supply Ph/Hz/V		1/50/230 - (±10%)							
Control box		MMI 813							
Total electrical power kW		0,37	0,6	0,56	0,75	1,4	1,8	2,6	5,5
Auxiliary electrical power kW		0,12	0,12	0,12	0,12	0,3	0,3	0,4	1
Protection level IP		44							
Motor electrical power kW		0,25	0,42	0,45	0,65	1,1	1,5	2,2	4,5
Rated motor current A		2,1	2,9	2 - 1,2	3 - 1,7	4,8 - 2,8	5,9 - 3,4	8,8 - 5,1	15,8 - 9,1
Motor start current A		4,8	11	9,5 - 5,5	13,8 - 8	25 - 14,6	27,7 - 16	57,2 - 33,2	126 - 73
Motor protection level IP		54							
Ignition transformer		230V - 1x8 kV							
		1A - 20 mA							
Operation		Intermittent (at least one stop every 24 h)							
Sound pressure dBA		68	70	70	72	75	77	78,5	83
Sound output W		--	--	--	--	--	--	--	--
CO Emission mg/kWh		< 40							
NOx Emission mg/kWh		< 130							
Directive		90/396 - 89/336 - 73/23 - 92/42 EEC							
Conforming to		EN 676							
Certification		CE 0085AP0733	CE 0085AP0734	CE 0085AP0735	CE 0085AP0944	CE 0085AP0945	CE 0085AP0946	CE 0085AT0042	

Reference conditions:  
 Temperature: 20°C  
 Pressure: 1013.5 mbar  
 Altitude: 100 m a.s.l.  
 Noise measured at a distance of 1 meter.

Since the Company is constantly engaged in the production improvement, the aesthetic and dimensional features, the technical data, the equipment and the accessories can be changed.  
 This document contains confidential and proprietary information of RIELLO S.p.A. Unless authorised, this information shall not be divulged, nor duplicated in whole or in part.

# FIRING RATES

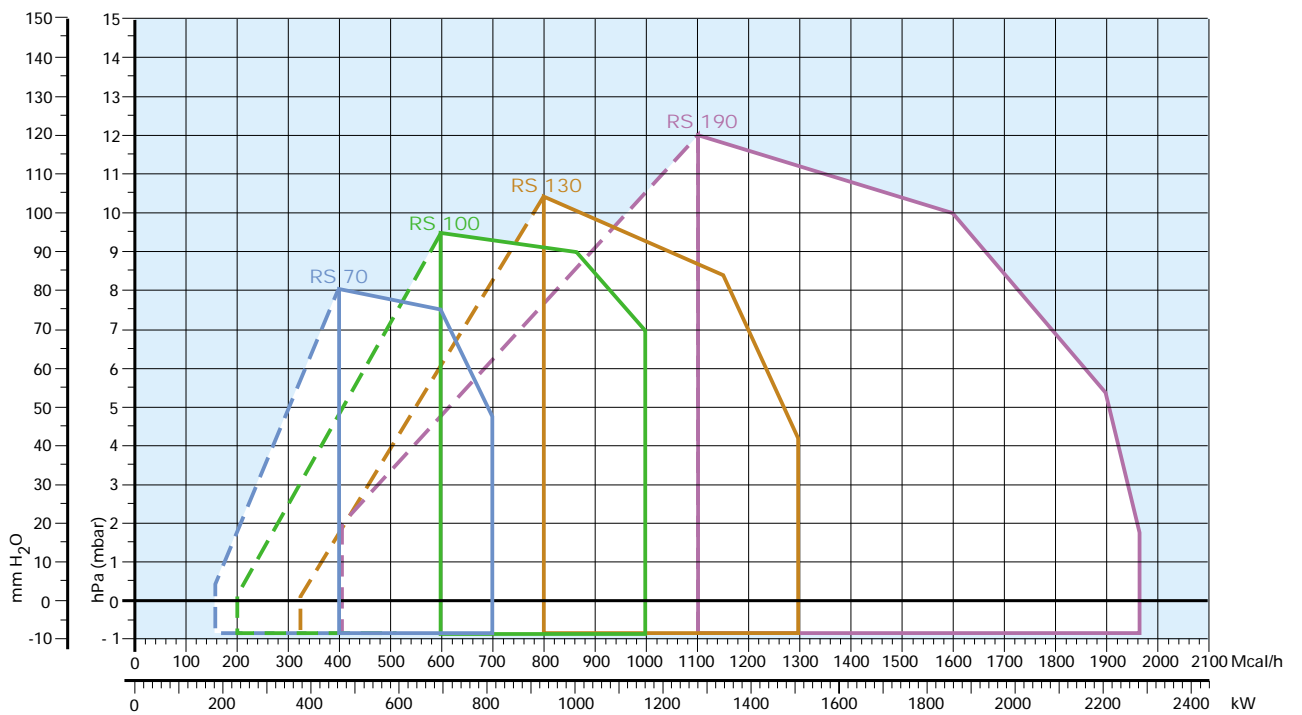
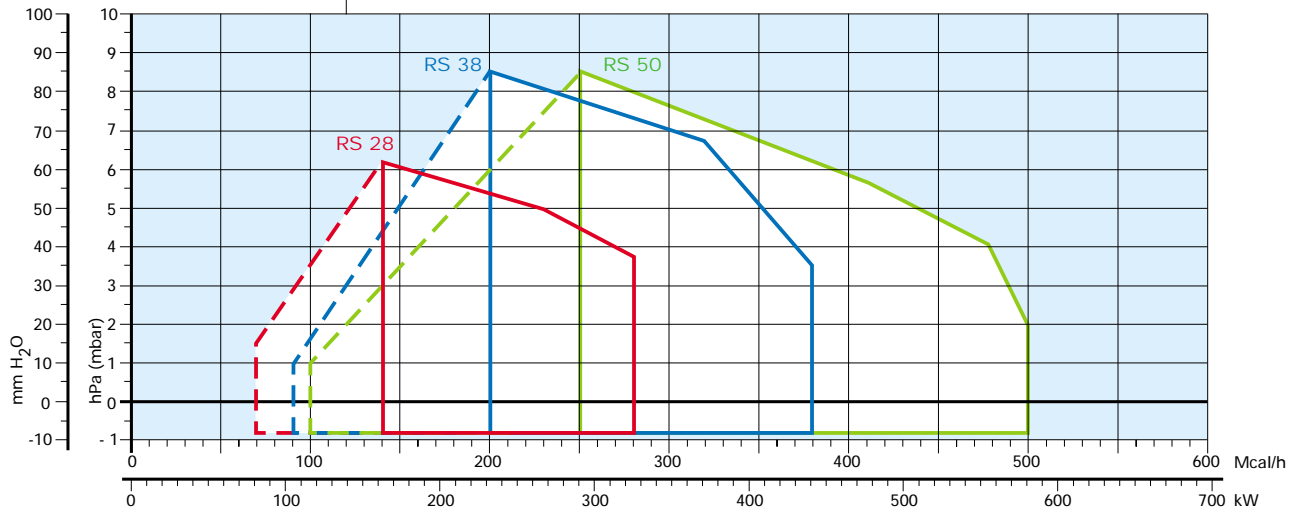

 Useful working field for choosing the burner

 1st stage operating range

Test conditions conforming to EN 676:

Temperature: 20°C  
 Pressure: 1013.5 mbar  
 Altitude: 100 m a.s.l.



# FUEL SUPPLY

## ▶ GAS TRAINS

The burners are fitted with a butterfly valve to regulate the fuel delivery on 1st and 2nd stage, controlled by a variable profile cam servomotor.

Fuel can be supplied either from the right or left hand sides.

The gas train can be selected to best fit system requirements depending on the fuel output and pressure in the supply line.

The gas train can be "Multibloc" type (containing the main components in a single unit) or "Composed" type (assembly of the single components).



Example of the variable profile cam on RS 70-100-130 burners.

### MULTIBLOC gas train without seal control

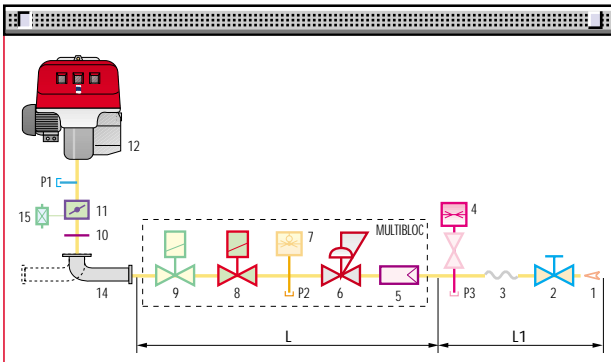

### MULTIBLOC gas train with seal control

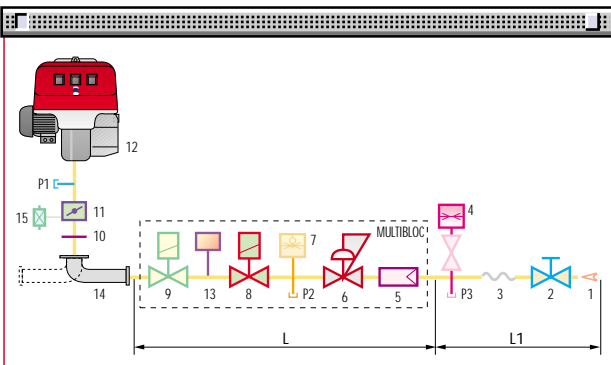

### COMPOSED gas train without seal control

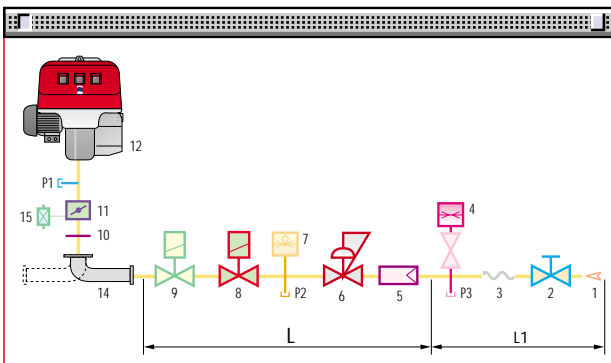

### COMPOSED gas train with seal control

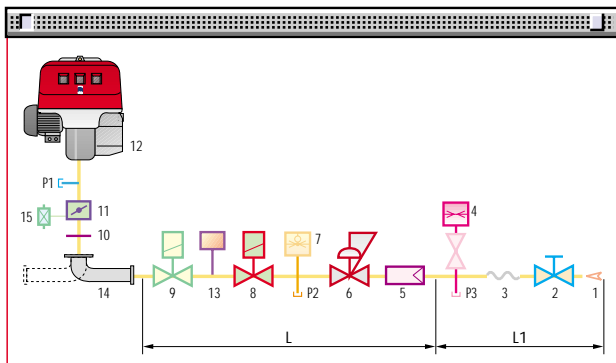

1	Gas input pipework
2	Manual valve
3	Anti-vibration joint
4	Pressure gauge with pushbutton cock.
5	Filter
6	Pressure regulator (vertical)
7	Minimum gas pressure switch
8	VS safety solenoid (vertical)
9	VR regulation solenoid (vertical) Two settings: - firing output (rapid opening) - maximum output (slow opening)
10	Gasket and flange supplied with the burner
11	Gas adjustment butterfly valve
12	Burner
13	Seal control mechanism for valves 8-9. According to standard EN 676, the seal control is compulsory for burners with maximum output above 1200 kW.
14	Gas train-burner adapter.
15	Maximum gas pressure switch
P1	Combustion head pressure
P2	Pressure downstream from the regulator
P3	Pressure upstream from the filter
L	Gas train supplied separately, with the code given in the table
L1	Installer's responsibility

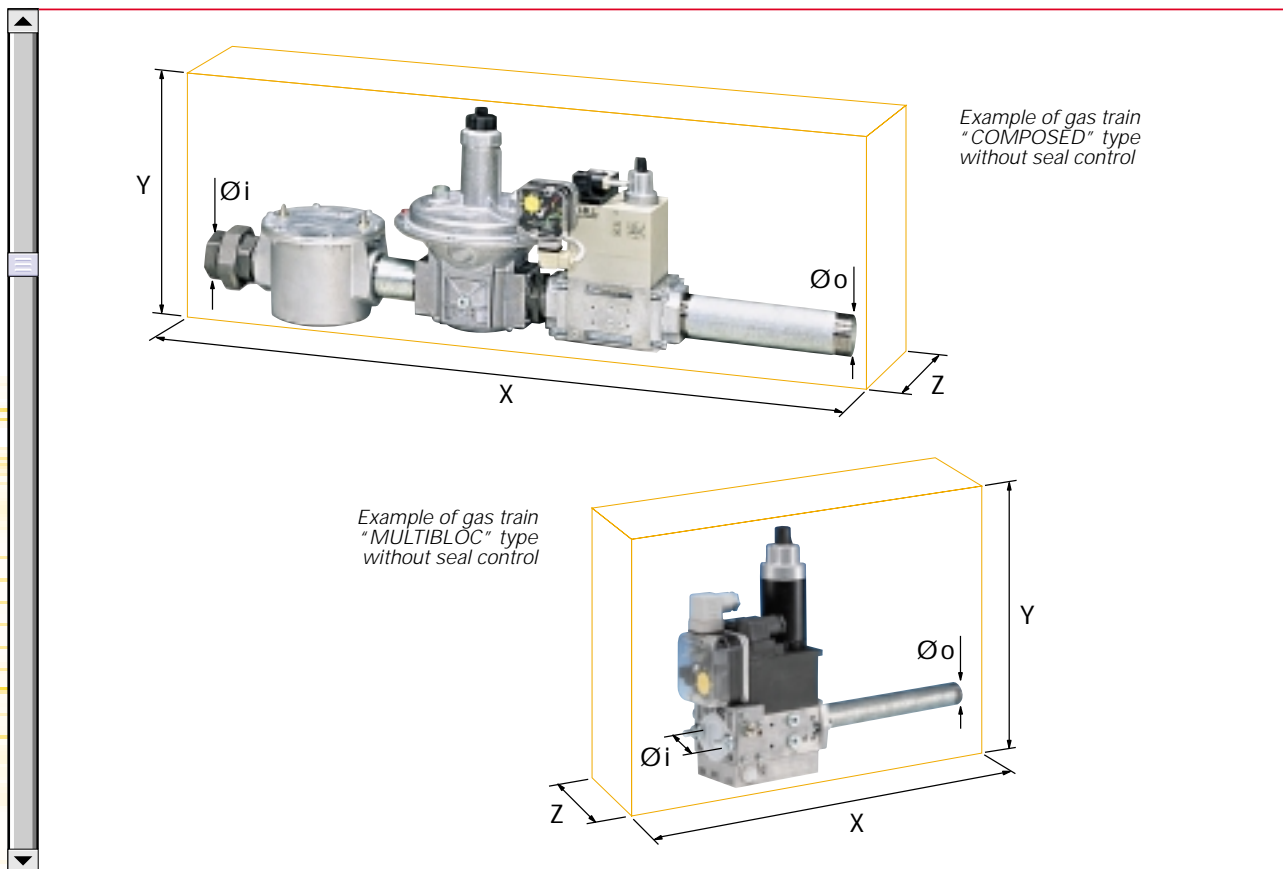

Gas trains are approved by standard EN 676 together with the burner.

The overall dimensions of the gas train depends on how they are constructed. The following table shows the maximum dimensions of the gas trains that can be fitted to RS burners, intake and outlet diameters and seal control if fitted.

Please note that the seal control can be installed as an accessory, if not already installed on the gas train.

The maximum gas pressure of gas train "Multibloc" type is 300 mbar, and that one of gas train "Composed" type is 500 mbar.

	Name	Code	Ø i	Ø o	X mm	Y mm	Z mm	Seal Control
MULTIBLOC GAS TRAINS	MBD 407	3970076	3/4"	3/4"	371	196	120	-
	MBD 410	3970077	1"	3/4"	405	217	145	-
	MBD 412	3970144	1" 1/4	1" 1/2	433	217	145	-
	MBD 412 CT	3970197	1" 1/4	1" 1/2	433	217	262	Incorporated
	MBD 415	3970180	1" 1/2	1" 1/2	523	250	100	-
	MBD 415 CT	3970198	1" 1/2	1" 1/2	523	250	227	Incorporated
	MBD 420	3970181	2"	2"	523	300	100	-
	MBD 420 CT	3970182	2"	2"	523	300	227	Incorporated
COMPOSED GAS TRAINS	CB 40/1	3970145	1" 1/2	1" 1/2	891	261	195	-
	CB 50/1	3970146	2"	2"	986	328	250	-
	CB 50/1 CT	3970160	2"	2"	986	328	320	Incorporated
	CBF 65/1	3970147	DN 65	DN 65	874	356	285	-
	CBF 65/1 CT	3970161	DN 65	DN 65	874	356	285	Incorporated
	CBF 80/1	3970148	DN 80	DN 80	934	416	285	-
	CBF 80/1 CT	3970162	DN 80	DN 80	934	416	285	Incorporated
	CBF 100/1	3970149	DN 100	DN 100	1054	501	350	-
CBF 100/1 CT	3970163	DN 100	DN 100	1054	501	350	Incorporated	

## ► PRESSURE DROP DIAGRAMS

The diagrams indicate the minimum pressure drop of the burners with the various gas trains that can be matched with them; at the value of these pressure drop add the combustion chamber pressure.

The value thus calculated represents the minimum required input pressure to the gas train.

### NATURAL GAS

RS 28

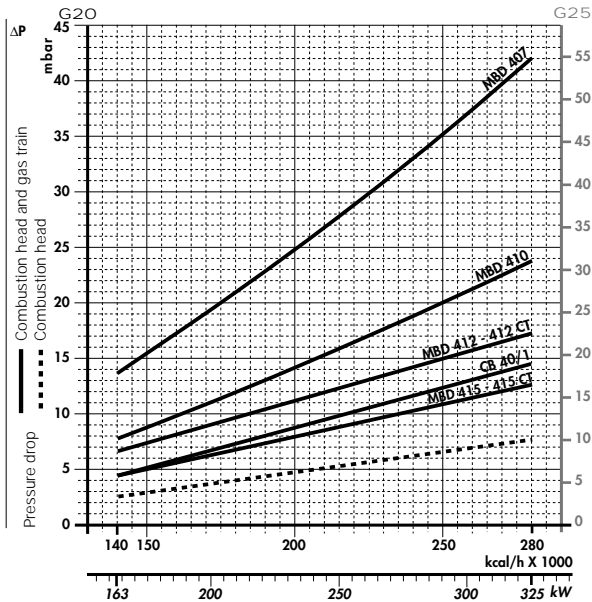

Gas train	Code	Adapter	Seal Control
MBD 407	3970076	3000824	Accessory
MBD 410	3970077	3000824	Accessory
MBD 412	3970144	-	Accessory
MBD 412 CT	3970197	-	Incorporated

### LPG

RS 28

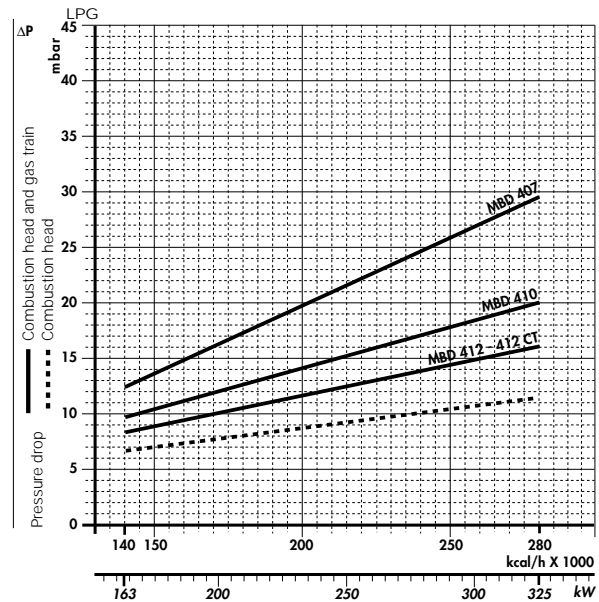

Gas train	Code	Adapter	Seal Control
CB 40/1	3970145	-	Accessory
MBD 415	3970180	-	Accessory
MBD 415 CT	3970198	-	Incorporated

RS 38

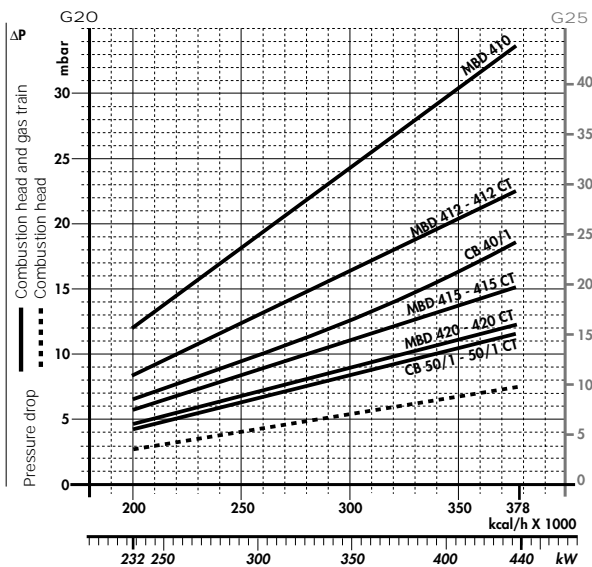

Gas train	Code	Adapter	Seal Control
MBD 407	3970076	3000824	Accessory
MBD 410	3970077	3000824	Accessory
MBD 412	3970144	-	Accessory
MBD 412 CT	3970197	-	Incorporated
CB 40/1	3970145	-	Accessory
MBD 415	3970180	-	Accessory

RS 38

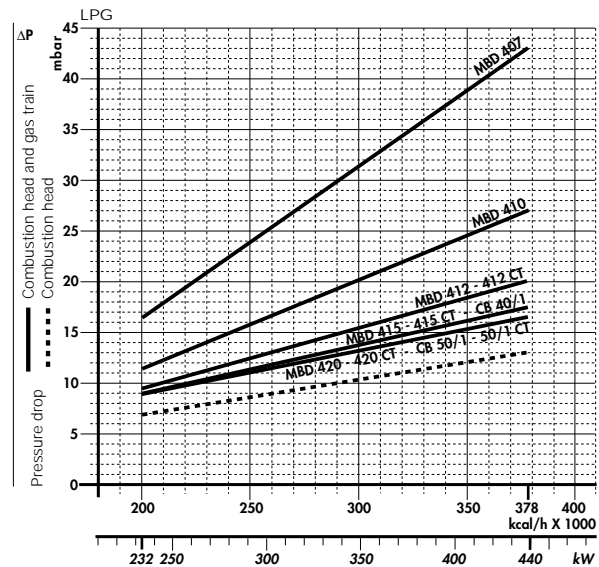

Gas train	Code	Adapter	Seal Control
MBD 415 CT	3970198	-	Incorporated
CB 50/1	3970146	3000822	Accessory
CB 50/1 CT	3970160	3000822	Incorporated
MBD 420	3970181	3000822	Accessory
MBD 420 CT	3970182	3000822	Incorporated



## NATURAL GAS

RS 50

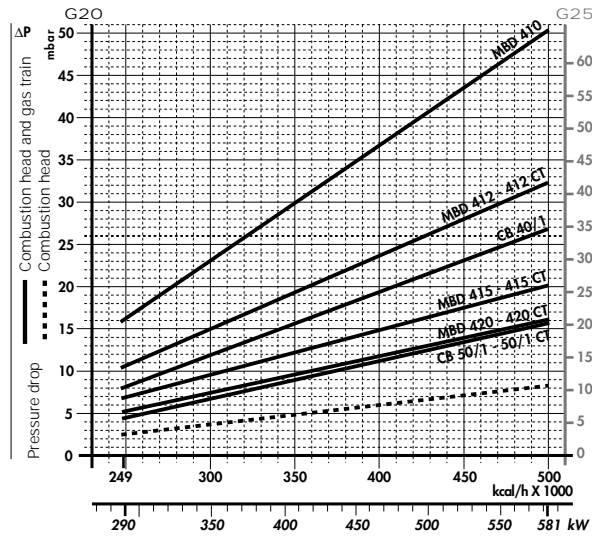

Gas train	Code	Adapter	Seal Control
MBD 407	3970076	3000824	Accessory
MBD 410	3970077	3000824	Accessory
MBD 412	3970144	-	Accessory
MBD 412 CT	3970197	-	Incorporated
CB 40/1	3970145	-	Accessory
MBD 415	3970180	-	Accessory

## LPG

RS 50

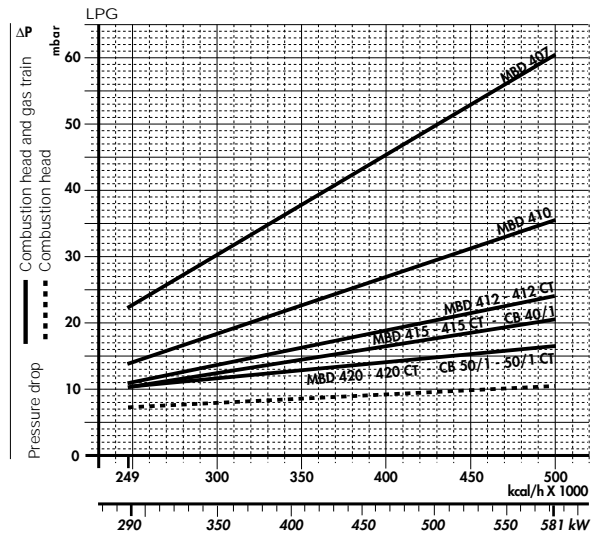

Gas train	Code	Adapter	Seal Control
MBD 415 CT	3970198	-	Incorporated
CB 50/1	3970146	3000822	Accessory
CB 50/1 CT	3970160	3000822	Incorporated
MBD 420	3970181	3000822	Accessory
MBD 420 CT	3970182	3000822	Incorporated

RS 70

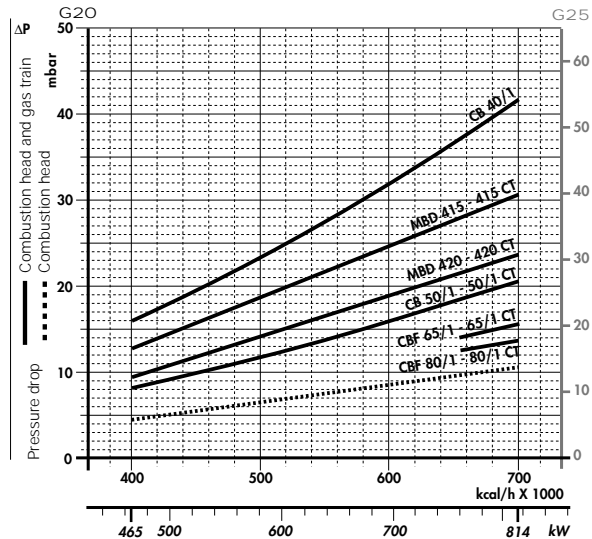

Gas train	Code	Adapter	Seal Control
CB 40/1	3970145	3000843	Accessory
MBD 415	3970180	3000843	Accessory
MBD 415 CT	3970198	3000843	Incorporated
CB 50/1	3970146	-	Accessory
CB 50/1 CT	3970160	-	Incorporated
MBD 420	3970181	-	Accessory

RS 70

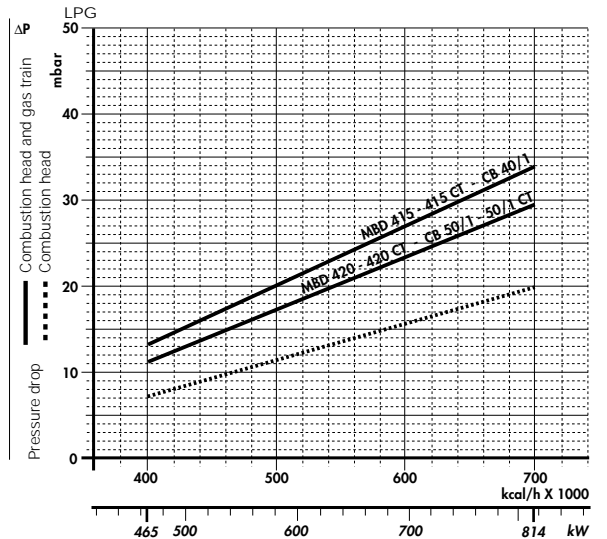

Gas train	Code	Adapter	Seal Control
MBD 420 CT	3970182	-	Incorporated
CBF 65/1	3970147	3000825	Accessory
CBF 65/1 CT	3970161	3000825	Incorporated
CBF 80/1	3970148	3000826	Accessory
CBF 80/1 CT	3970162	3000826	Incorporated

## NATURAL GAS

RS 100

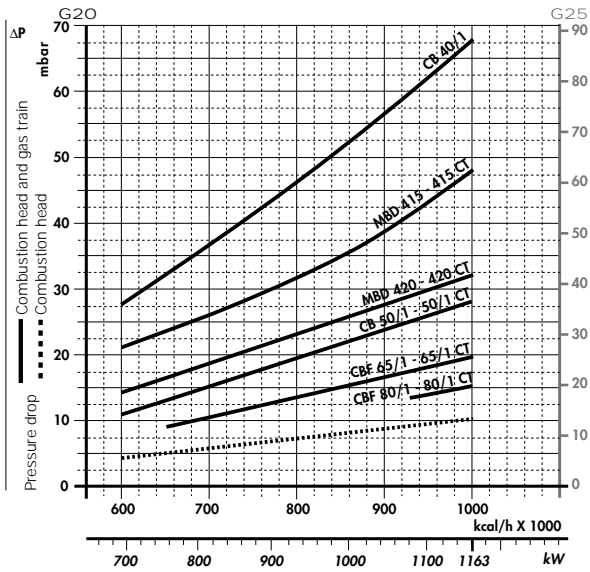

Gas train	Code	Adapter	Seal Control
CB 40/1	3970145	3000843	Accessory
MBD 415	3970180	3000843	Accessory
MBD 415 CT	3970198	3000843	Incorporated
CB 50/1	3970146	-	Accessory
CB 50/1 CT	3970160	-	Incorporated
MBD 420	3970181	-	Accessory

## LPG

RS 100

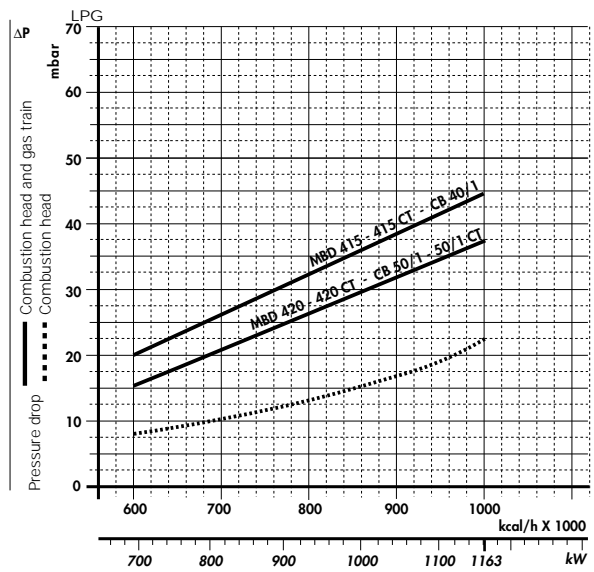

Gas train	Code	Adapter	Seal Control
MBD 420 CT	3970182	-	Incorporated
CBF 65/1	3970147	3000825	Accessory
CBF 65/1 CT	3970161	3000825	Incorporated
CBF 80/1	3970148	3000826	Accessory
CBF 80/1 CT	3970162	3000826	Incorporated

RS 130

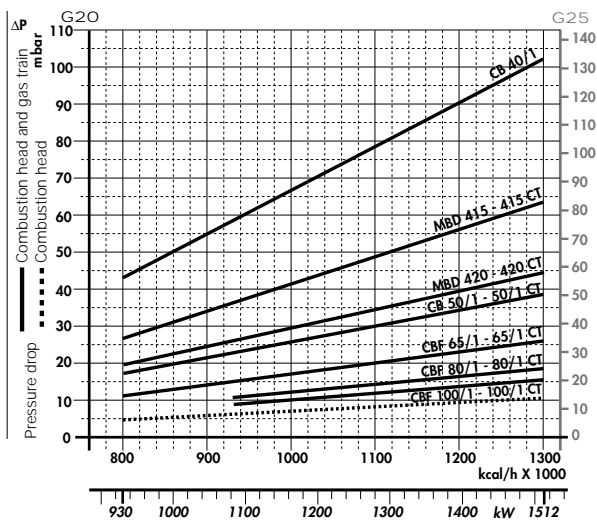

Gas train	Code	Adapter	Seal Control
CB 40/1	3970145	3000843	Accessory
MBD 415	3970180	3000843	Accessory
MBD 415 CT	3970198	3000843	Incorporated
CB 50/1	3970146	-	Accessory
CB 50/1 CT	3970160	-	Incorporated
MBD 420	3970181	-	Accessory
MBD 420 CT	3970182	-	Incorporated

RS 130

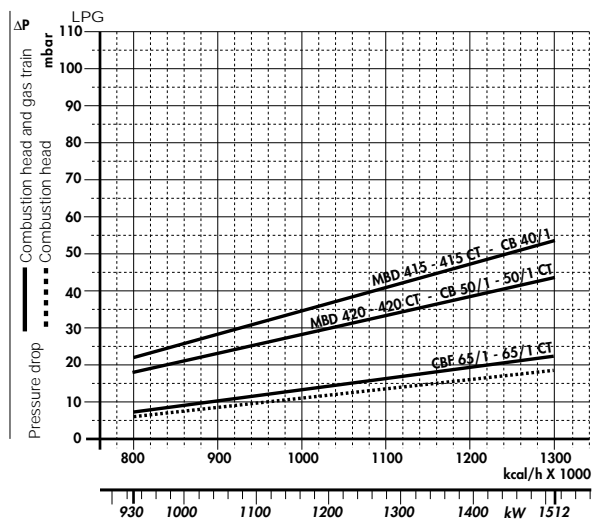

Gas train	Code	Adapter	Seal Control
CBF 65/1	3970147	3000825	Accessory
CBF 65/1 CT	3970161	3000825	Incorporated
CBF 80/1	3970148	3000826	Accessory
CBF 80/1 CT	3970162	3000826	Incorporated
CBF 100/1	3970149	3010223 3000826	Accessory
CBF 100/1 CT	3970163	3010223 3000826	Incorporated





### NATURAL GAS

### LPG

RS 190

RS 190

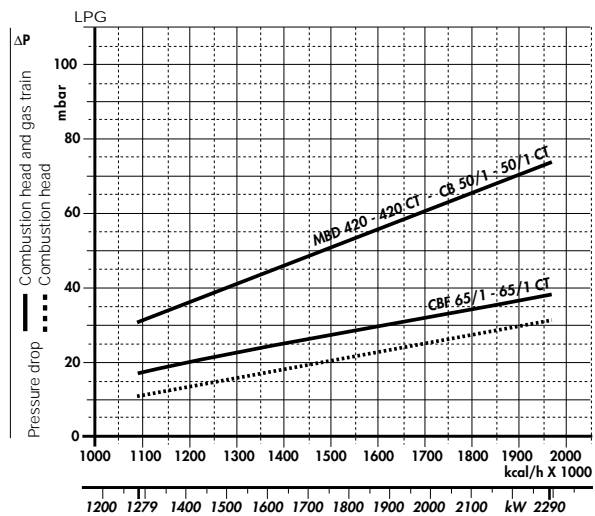
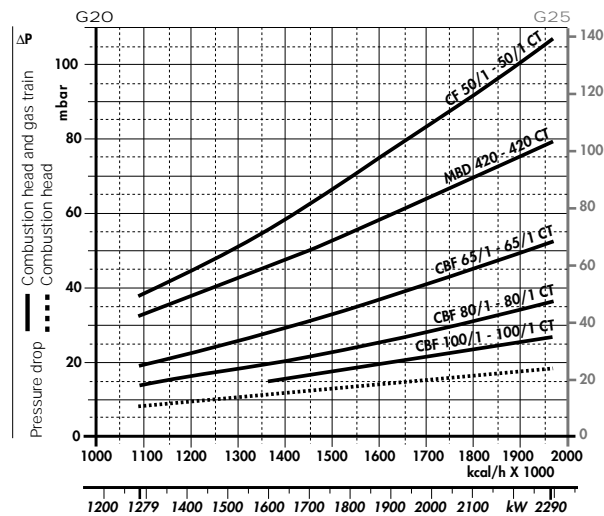

Gas train	Code	Adapter	Seal Control
CB 50/1	3970146	3010128	Accessory
CB 50/1 CT	3970160	3010128	Incorporated
MBD 420	3970181	3010128	Accessory
MBD 420 CT	3970182	3010128	Incorporated
CBF 65/1	3970147	3000831	Accessory

Gas train	Code	Adapter	Seal Control
CBF 65/1 CT	3970161	3000831	Incorporated
CBF 80/1	3970148	3000832	Accessory
CBF 80/1 CT	3970162	3000832	Incorporated
CBF 100/1	3970149	3010127	Accessory
CBF 100/1 CT	3970163	3010127	Incorporated

**note** Please contact the Riello Burner Technical Office for different pressure levels from those above indicated.

## SELECTING THE FUEL SUPPLY LINES

The following diagram enables pressure drop in a pre-existing gas line to be calculated and to select the correct gas train.

The diagram can also be used to select a new gas line when fuel output and pipe length are known. The pipe diameter is selected on the basis of the desired pressure drop. The diagram uses methane gas as reference; if another gas is used, conversion coefficient and a simple formula (on the diagram) transform the gas output to a methane equivalent (refer to figure A). Please note that the gas train dimensions must take into account the back pressure of the combustion chamber during operations.

Control of the pressure drop in an existing gas line or selecting a new gas supply line. The methane output equivalent is determined by the formula fig. A on the diagram and the conversion coefficient.

Once the equivalent output has been determined on the delivery scale ( $\dot{V}$ ), shown at the top of the diagram, move vertically downwards until you cross the line that represents the pipe diameter; at this point, move horizontally to the left until you meet the line that represents the pipe length. Once this point is established you can verify, by moving vertically downwards, the pipe pressure drop of on the bottom scale below (mbar).

By subtracting this value from the pressure measured on the gas meter, the correct pressure value will be found for the choice of gas train.

Example: - gas used G25  
 - gas output 9.51 mc/h  
 - pressure at the gas meter 20 mbar  
 - gas line length 15 m  
 - conversion coefficient 0.62 (see figure A)

$$\text{- equivalent methane output } \dot{V} = \left[ \frac{9.51}{0.62} \right] = 15.34 \text{ mc/h}$$

- once the value of 15.34 has been identified on the output scale ( $\dot{V}$ ), moving vertically downwards you cross the line that represents 1" 1/4 (the chosen diameter for the piping);
- from this point, move horizontally to the left until you meet the line that represents the length of 15 m of the piping;
- move vertically downwards to determine a value of 1.4 mbar in the pressure drop bottom scale;
- subtract the determined pressure drop from the meter pressure, the correct pressure level will be found for the choice of gas train;
- correct pressure = ( 20-1.4 ) = 18.6 mbar

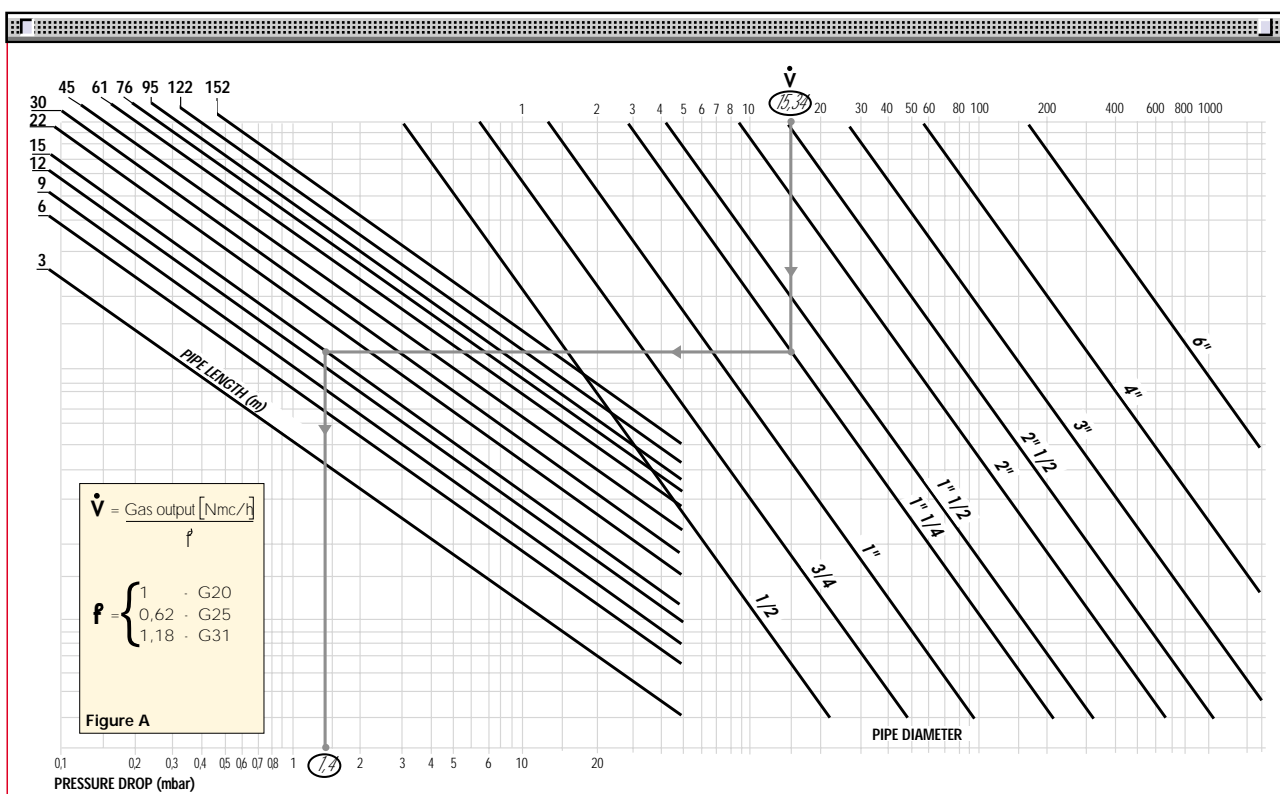

## VENTILATION



The ventilation circuit produces low noise levels with high performance pressure and air output, inspite of the compact dimensions.



Example of the air damper on RS 28 - 38 - 50 burners

Except for the RS 190 model, the use of reverse curve blades and sound-proofing material keeps noise level very low. In the RS 190 model, noise has been reduced by the special design of the air suction circuit.

A variable profile cam connects the fuel and air regulations, to obtain a perfect control of combustion during the change of stage. When the burner is not operating the servomotor closes completely the air damper to reduce heat dispersion from the boiler.

A minimum air pressure switch stops the burner when there is an insufficient quantity of air at the combustion head.

## COMBUSTION HEAD



Different lengths of the combustion head can be chosen for the RS series of burners.



The choice depends on the thickness of the front panel and the type of boiler.

Depending on the type of generator, check that the penetration of the head into the combustion chamber is correct.

The internal positioning of the combustion head can easily be adjusted to the maximum defined output by adjusting a screw fixed to the flange.

Example of a RS burner combustion head

### Dimensions of the flame

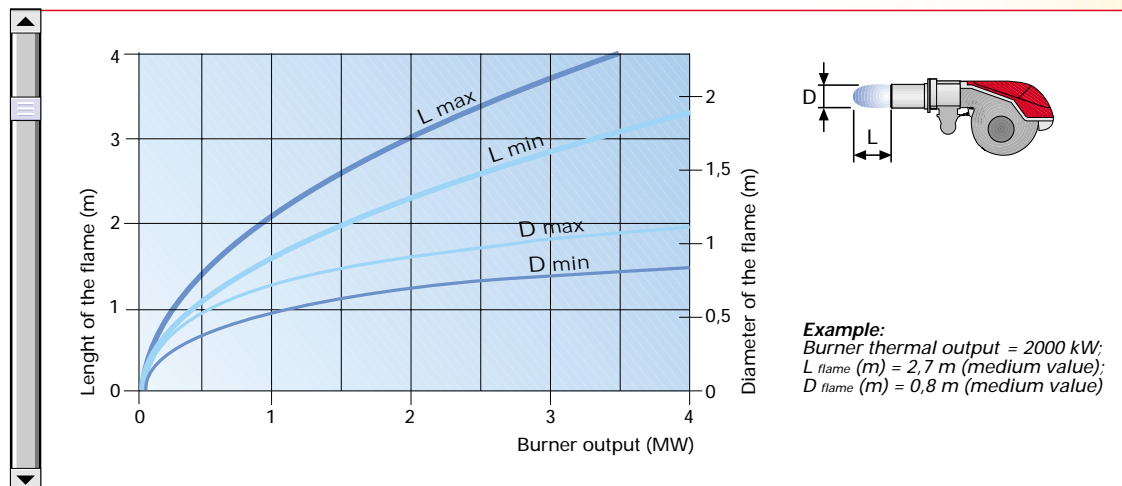



# ADJUSTMENT

## BURNER OPERATION MODE

On "two stage" operation, the burner gradually adapts the output to the requested level, by varying between two pre-set levels (see figure A).

### "Two stage" operation

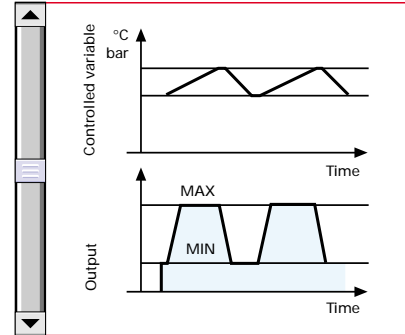

Figure A



Example of "STATUS PANEL"

The RS burners are equipped of an exclusive electronic device "STATUS PANEL" or "LED PANEL" that, in every moments, shows all burners operational modes and finds eventual anomalies during the operational cycle.

## FIRING

### RS 28-38-50-70-100-130-190

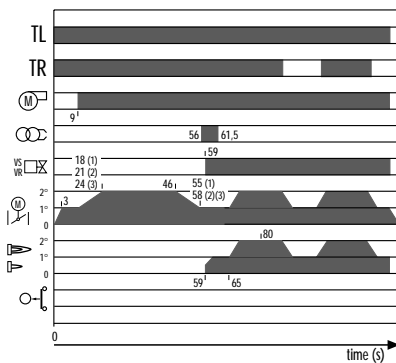

- (1) RS 28-38-50
- (2) RS 70-100-130
- (3) RS 190

- The TL remote control closes; servomotor starts after about 3".
- 0" The control box starting cycle begins.
- 9" Fan motor starts. The air damper is positioned to 2nd stage.
- 18/21/24" Pre-ventilation stage.
- 46" Servomotor rotates.
- 55" The air damper and the gas butterfly valve are positioned to 1st stage output (for RS 28-38-50).
- 56" Ignition electrode sparks.
- 58" The air damper and the gas butterfly valve are positioned to 1st stage output (for RS 70-100-130-190).
- 59" Firing; the VS safety valve and the VR adjustment valve open.
- 65" Output can be increased.
- 80" The control box starting cycle ends.

# ELECTRICAL CONNECTIONS

*To be made by the installer*



Electrical connections must be made by qualified and skilled personnel, according to the local regulations.

Example of the terminal board for electrical connections for the RS 70-100-130-190 models

## “ TWO STAGE ” OPERATION - Single-phase power supply

### RS 28-38 - without seal control

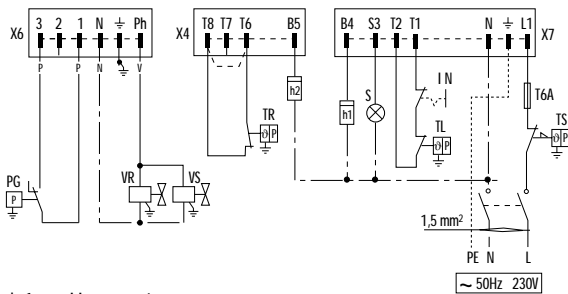

- h1 - Hour meter
- h2 - Hour meter
- IN - Manual switch
- MB - Burner auxiliary terminal board
- X4 - 4 pin plug
- X6 - 6 pin plug
- X7 - 7 pin plug
- PG - Minimum gas pressure switch
- S - External lock-out signal
- TR - High/low flame setting thermostat
- TL - Threshold thermostat
- TS - Safety thermostat
- VR - Adjustment valve
- VS - Safety valve
- T6A - 6A fuse

### RS 28-38 - with seal control

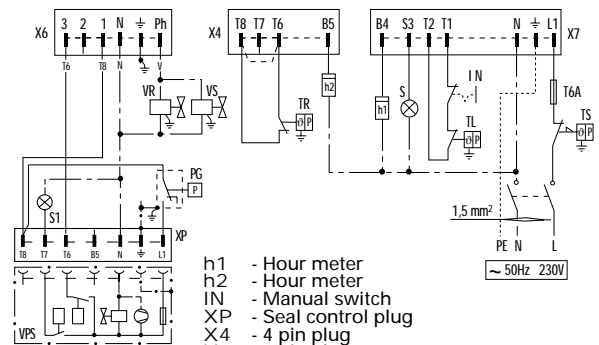

- h1 - Hour meter
- h2 - Hour meter
- IN - Manual switch
- XP - Seal control plug
- X4 - 4 pin plug
- X6 - 6 pin plug
- X7 - 7 pin plug
- PG - Minimum gas pressure switch
- S - External lock-out signal
- S1 - External lock-out signal on the seal control
- TR - High/low flame setting thermostat
- TL - Threshold thermostat
- TS - Safety thermostat
- VPS - Seal control
- VR - Adjustment valve
- VS - Safety valve
- T6A - 6A fuse

## “ TWO STAGE ” OPERATION - Triple-phase power supply

### RS 38-50 - without seal control

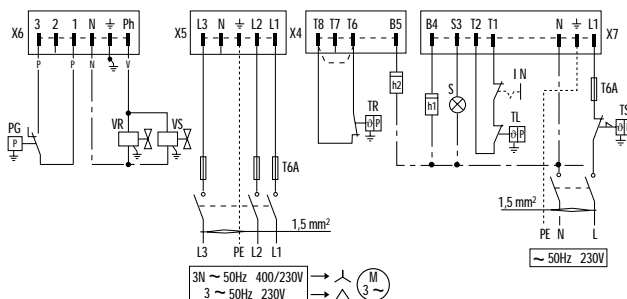

- h1 - Hour meter
- h2 - Hour meter
- IN - Manual switch
- MB - Burner auxiliary terminal board
- X4 - 4 pin plug
- X5 - 5 pin plug
- X6 - 6 pin plug
- X7 - 7 pin plug
- PG - Minimum gas pressure switch
- S - External lock-out signal
- TR - High/low flame setting thermostat
- TL - Threshold thermostat
- TS - Safety thermostat
- VR - Adjustment valve
- VS - Safety valve
- T6A - 6A fuse

### RS 38-50 - with seal control

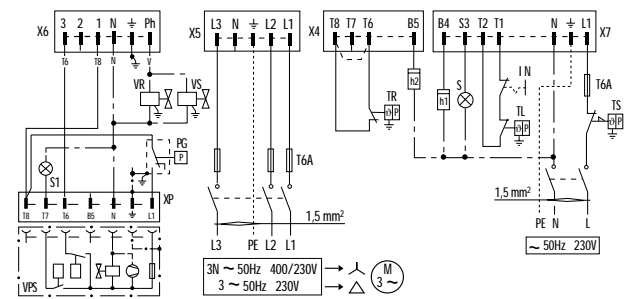

- h1 - Hour meter
- h2 - Hour meter
- IN - Manual switch
- XP - Seal control plug
- X4 - 4 pin plug
- X5 - 5 pin plug
- X6 - 6 pin plug
- X7 - 7 pin plug
- PG - Minimum gas pressure switch
- S - External lock-out signal
- S1 - External lock-out signal on the seal control
- TR - High/low flame setting thermostat
- TL - Threshold thermostat
- TS - Safety thermostat
- VPS - Seal control
- VR - Adjustment valve
- VS - Safety valve
- T6A - 6A fuse

### RS 70-100-130-190 - without seal control

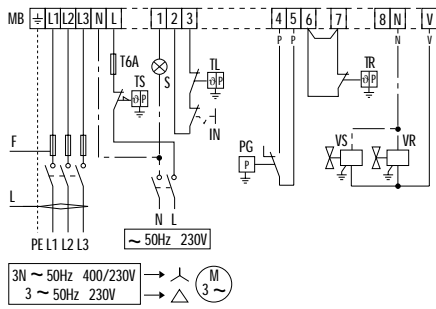

- MB - Burner terminal board
- IN - Manual switch
- PG - Minimum gas pressure switch
- S - External lock-out signal
- TR - High/low flame setting thermostat
- TL - Threshold thermostat
- TS - Safety thermostat
- VR - Adjustment valve
- VS - Safety valve
- T6A - 6A fuse
- F - Fuse (see table A)
- L - Lead section (see table A)

### RS 70-100-130-190 - with seal control

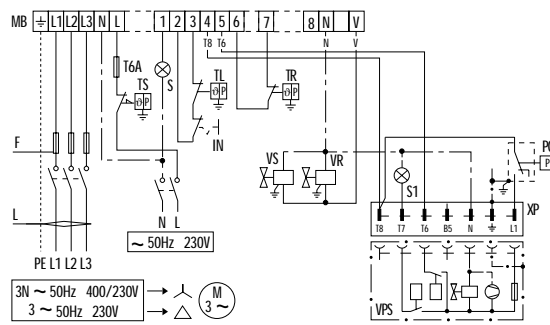

- MB - Burner terminal board
- IN - Manual switch
- XP - Seal control plug
- PG - Minimum gas pressure switch
- S - External lock-out signal
- S1 - External lock-out signal on the seal control
- TR - High/low flame setting thermostat
- TL - Threshold thermostat
- TS - Safety thermostat
- VPS - Seal control
- VR - Adjustment valve
- VS - Safety valve
- T6A - 6A fuse
- F - Fuse (see table A)
- L - Lead section (see table A)

The following table shows the supply lead sections and the type of fuse to be used.

Model	▼ RS 28	▼ RS 38	▼ RS 38	▼ RS 50	▼ RS 70	▼ RS 100	▼ RS 130	▼ RS 190
	230V	230V	230V	400V	230V	400V	230V	400V
F A	T6	T6	T6	T6	T6	T6	T10	T6
L mm <sup>2</sup>	1,5	1,5	1,5	1,5	1,5	1,5	1,5	1,5

Table A



## EMISSIONS

NO<sub>2</sub> EMISSIONS

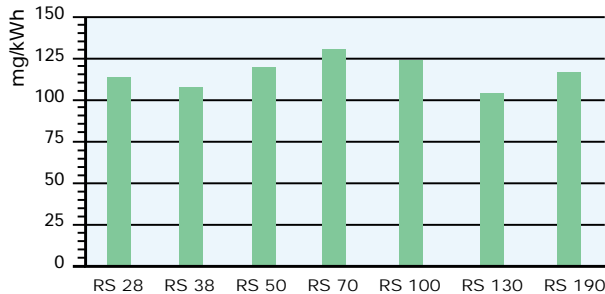

CO EMISSIONS

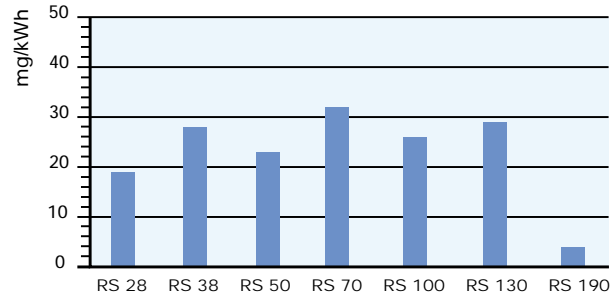

NOISE EMISSIONS

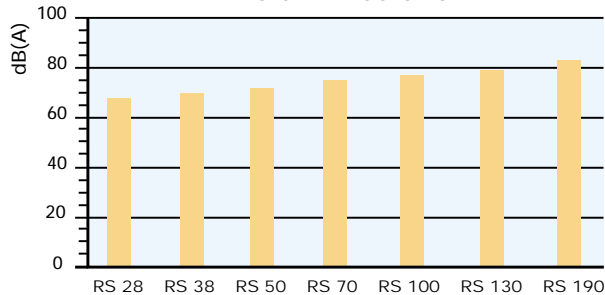

The emission data has been measured in the various models at maximum output, according to EN 676 standard.

# OVERALL DIMENSIONS (mm)



## BURNERS

### RS 28 - 38 - 50

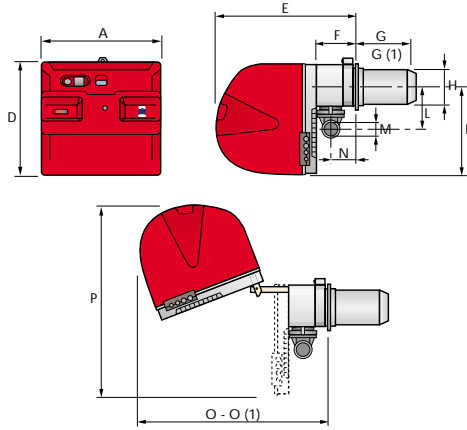

### RS 70 - 100 - 130

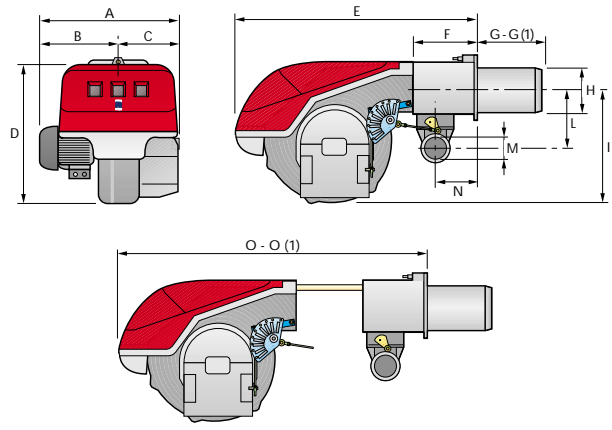

### RS 190

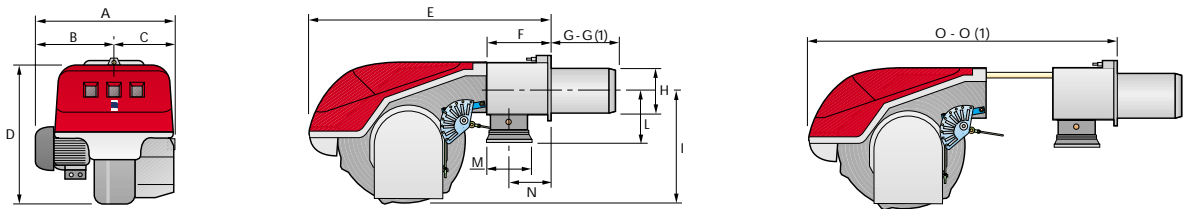

Model	A	B	C	D	E	F	G - G (1)	H	I	L	M	N	O - O (1)	P
▶ RS 28	476	-	-	474	580	164	216 - 351	140	352	168	1"1/2	108	810	719
▶ RS 38	476	-	-	474	580	164	216 - 351	140	352	168	1"1/2	108	810	719
▶ RS 50	476	-	-	474	580	164	216 - 351	152	352	168	1"1/2	108	810	719
▶ RS 70	511	296	215	555	840	214	250 - 385	179	430	221	2"	134	1161 - 1296	-
▶ RS 100	527	312	215	555	840	214	250 - 385	179	430	221	2"	134	1161 - 1296	-
▶ RS 130	553	338	215	555	840	214	280 - 415	189	430	221	2"	134	1161 - 1296	-
▶ RS 190	681	366	315	555	856	230	372	222	430	186	DN80	150	1312	-

(1) "Extended" head model

## BURNER - BOILER MOUNTING FLANGE

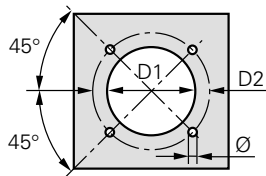

Model	D1	D2	Ø
▶ RS 28	160	224	M8
▶ RS 38	160	224	M8
▶ RS 50	160	224	M8
▶ RS 70	185	275 - 325	M12
▶ RS 100	185	275 - 325	M12
▶ RS 130	195	275 - 325	M12
▶ RS 190	230	325 - 368	M16

## PACKAGING

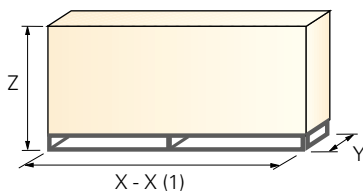

Model	X - X (1)	Y	Z	kg
▶ RS 28	872 - 1007	540	550	38
▶ RS 38	872 - 1007	540	550	40
▶ RS 50	872 - 1007	540	550	41
▶ RS 70	1190 - 1325	692	740	70
▶ RS 100	1190 - 1325	692	740	73
▶ RS 130	1190 - 1325	692	740	76
▶ RS 190	1250	785	725	82

(1) "Extended" head model

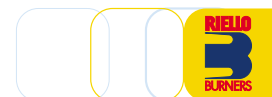



## INSTALLATION DESCRIPTION

Installation, start up and maintenance must be carried out by qualified and skilled personnel. All operations must be performed in accordance with the technical handbook supplied with the burner.

### BURNER SETTING

- ▶ All the burners have slide bars, for easier installation and maintenance.
- ▶ After drilling the boilerplate, using the supplied gasket as a template, dismantle the blast tube from the burner and fix it to the boiler.
- ▶ Adjust the combustion head.
- ▶ Fit the gas train, choosing this on the basis of the maximum output of the boiler and considering the enclosed diagrams.
- ▶ Refit the burner casing to the slide bars.
- ▶ Close the burner, sliding it up to the flange.



### ELECTRICAL CONNECTIONS AND START UP

- ▶ Make the electrical connections to the boiler following the wiring diagrams included in the instruction handbook.
- ▶ Turn the motor to check rotation direction (if it is a three-phase motor).
- ▶ Perform a first ignition calibration on the gas train.
- ▶ On start up, check:
  - Gas pressure at the combustion head (to max. and min. output)
  - Combustion quality, in terms of unburned substances and excess air.





## ACCESSORIES



### Extended heads

“Standard head” burners can be transformed into “extended head” versions, by using the special kit. The KITS available for the various burners, giving the original and the extended lengths, are listed below.

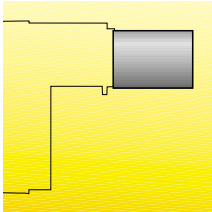

Combustion head extension kits			
Burner	'Standard head' length (mm)	'Extended head' length (mm)	Kit code
RS 28	216	351	3010076
RS 38	216	351	3010077
RS 50	216	351	3010078
RS 70	250	385	3010117
RS 100	250	385	3010118
RS 130	280	415	3010119
RS 190	372	530	3010196

### Spacer kit

If burner head penetration into the combustion chamber needs reducing, varying thickness spacers are available, as given in the following table:

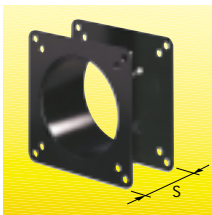

Head length reduction kit		
Burner	Spacer thickness S (mm)	Kit code
RS 28 - 38 - 50	90	3010095
RS 70 - 100 - 130	135	3010129
RS 190	110	3000722

### Continuous ventilation kit

If the burner requires continuous ventilation in the stages without flame, a special kit is available as given in the following table:



Continuous ventilation kit	
Burner	Kit code
RS 28 - 38 - 50	3010094
RS 70 - 100 - 130 - 190	3010094

### Sound proofing box

If noise emission needs reducing even further, sound-proofing boxes are available, as given in the following table:



Sound proofing box		
Burner	Box type	Box code
RS 28 - 38 - 50	C2	3000777
RS 70 - 100 - 130 - 190	C3	3000778



## LPG kit

For burning LPG gas, a special kit is available to be fitted to the combustion head on the burner, as given in the following table:



LPG kit		
Burner	Kit code for 'standard head'	Kit code for 'extended head'
RS 28	3010079	3010080
RS 38	3010081	3010082
RS 50	3010083	3010084
RS 70	3010097	3010098
RS 100	3010099	3010100
RS 130	3010101	3010102
RS 190	3010166	-

# GAS TRAIN ACCESSORIES

## Adapters

When the diameter of the gas train is different from the set diameter of the burners, an adapter must be fitted between the gas train and the burner. The following table lists the adapters for various burners.

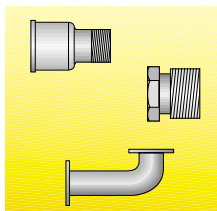

Adapters			
Burner	Gas train	Dimensions	Adapter code
RS 28	MBD 407 - 410	3/4"  1" 1/2"	<b>3000824</b>
RS 38	MBD 407 - 410	3/4"  1" 1/2"	<b>3000824</b>
	MBD 420 - CB 50/1	2"  1" 1/2"	<b>3000822</b>
RS 50	MBD 407 - 410	3/4"  1" 1/2"	<b>3000824</b>
	MBD 420 - CB 50/1	2"  1" 1/2"	<b>3000822</b>
RS 70	MBD 415 - CB 40/1	1" 1/2"  2"	<b>3000843</b>
	CBF 65/1	DN 65  2" 1/2"	<b>3000825</b>
	CBF 80/1	DN 80  2" 1/2"	<b>3000826</b>
RS 100	MBD 415 - CB 40/1	1" 1/2"  2"	<b>3000843</b>
	CBF 65/1	DN 65  2" 1/2"	<b>3000825</b>
	CBF 80/1	DN 80  2" 1/2"	<b>3000826</b>
RS 130	MBD 415 - CB 40/1	1" 1/2"  2"	<b>3000843</b>
	CBF 65/1	DN 65  2" 1/2"	<b>3000825</b>
	CBF 80/1	DN 80  2" 1/2"	<b>3000826</b>
	CBF 100/1	DN 100	<b>3010223</b>
RS 190	CBF 100/1	DN 80  2" 1/2"	<b>3000826</b>
	MBD 420 - CB 50/1	DN 80   2" 1/2"	<b>3010128</b>
	CBF 65/1	DN 65	<b>3000831</b>
	CBF 80/1	DN 80	<b>3000832</b>
	CBF 100/1	DN 100	<b>3010127</b>



## Seal control kit

To test the valve seals on the gas train, a special "seal control kit" is available. The valve seal control device is compulsory (EN 676) on gas trains to burners with a maximum output over 1200 kW. The sealing control is type VPS 504.



Seal control kit		
Burner	Gas train	Kit code
RS 28	MBD 407 - 410 - 412 - 415 - CB 40/1	<b>3010123</b>
RS 38	MBD 407 - 410 - 412 - 415 - 420 - CB 40/1 - 50/1	<b>3010123</b>
RS 50	MBD 407 - 410 - 412 - 415 - 420 - CB 40/1 - 50/1	<b>3010123</b>
RS 70	MBD 415 - 420 - CB 40/1 - 50/1 - CBF 65/1 - 80/1	<b>3010123</b>
RS 100	MBD 415 - 420 - CB 40/1 - 50/1 - CBF 65/1 - 80/1	<b>3010123</b>
RS 130	MBD 415 - 420 - CB 40/1 - 50/1 - CBF 65/1 - 80/1 - 100/1	<b>3010123</b>
RS 190	MBD 420 - CB 50/1 - CBF 65/1 - 80/1 - 100/1	<b>3010123</b>

## Stabiliser spring

Accessory springs are available to vary the pressure range of the gas train stabilisers. The following table shows these accessories with their application range

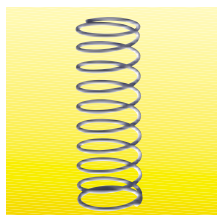

Stabiliser springs		
Gas train	Spring	Code
CBF 65/1 - CBF 80/1	Red da 25 a 55 mbar	<b>3010133</b>
CBF 100/1	Red da 25 a 55 mbar	<b>3010134</b>
CBF 65/1 - CBF 80/1	Black da 60 a 110 mbar	<b>3010135</b>
CBF 100/1	Black da 60 a 110 mbar	<b>3010136</b>
CBF 65/1 - CBF 80/1	Pink da 90 a 150 mbar	<b>3090456</b>
CBF 100/1	Pink da 90 a 150 mbar	<b>3090489</b>

Please refer to the technical manual for the correct choice of spring.

# SPECIFICATION



A specific index guides your choice of burner from the various models available in the RS series. Below is a clear and detailed specification description of the product.

## DESIGNATION OF SERIES R BURNERS

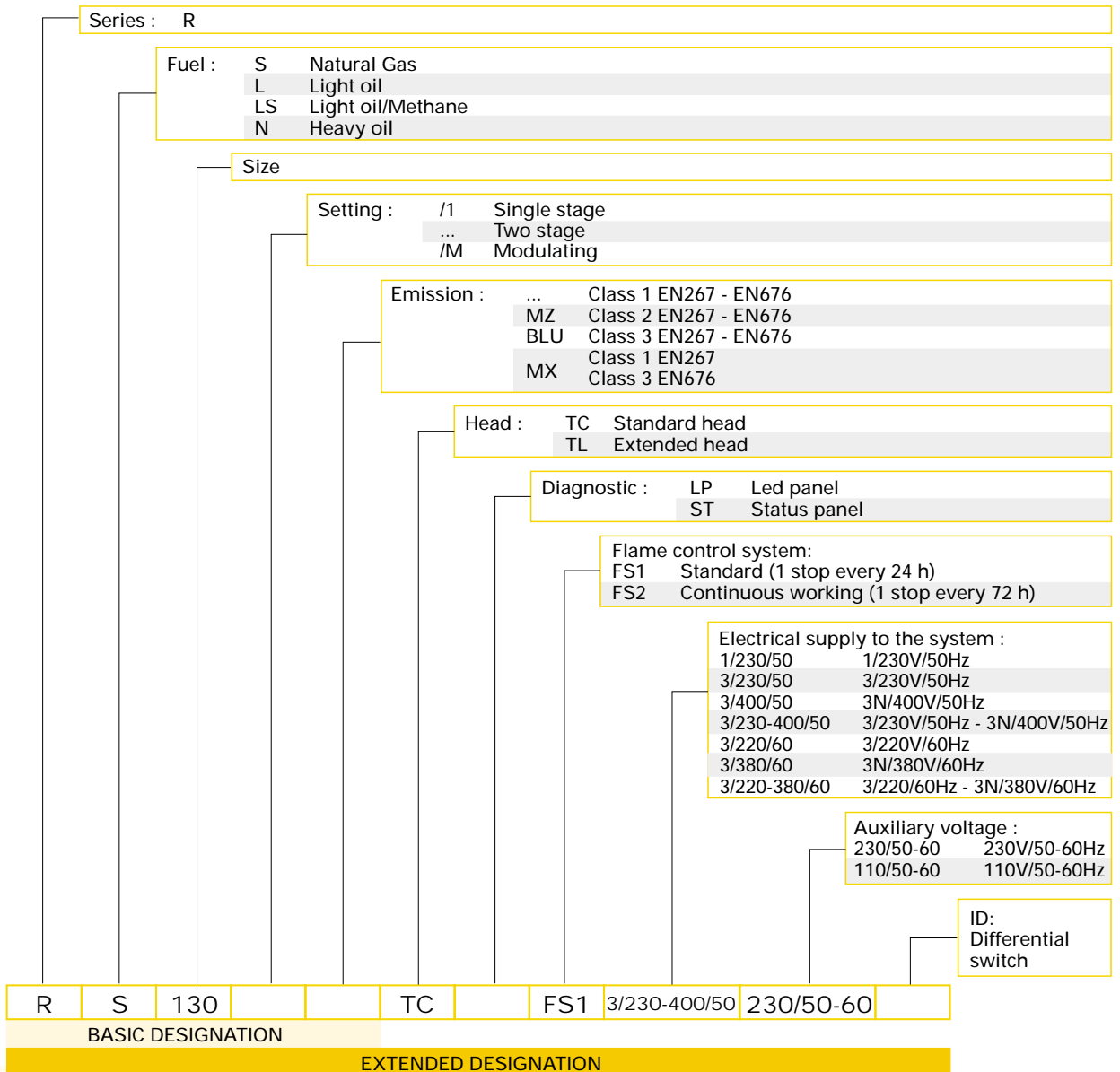



▶ LIST OF AVAILABLE MODELS

RS 28	TC	LP	FS1	1/230/50	230/50-60		RS 70	TC	LP	FS1	3/230-400/50	230/50-60	
RS 28	TC	LP	FS1	1/230/50	230/50-60	ID	RS 70	TC	LP	FS1	3/230-400/50	230/50-60	ID
RS 28	TC	ST	FS1	1/230/50	230/50-60		RS 70	TC	ST	FS1	3/230-400/50	230/50-60	
RS 28	TC	ST	FS1	1/230/50	230/50-60	ID	RS 70	TC	ST	FS1	3/230-400/50	230/50-60	ID
RS 28	TL	LP	FS1	1/230/50	230/50-60		RS 70	TL	LP	FS1	3/230-400/50	230/50-60	
RS 28	TL	LP	FS1	1/230/50	230/50-60	ID	RS 70	TL	LP	FS1	3/230-400/50	230/50-60	ID
RS 28	TL	ST	FS1	1/230/50	230/50-60		RS 70	TL	ST	FS1	3/230-400/50	230/50-60	
RS 28	TL	ST	FS1	1/230/50	230/50-60	ID	RS 70	TL	ST	FS1	3/230-400/50	230/50-60	ID
RS 38	TC	LP	FS1	1/230/50	230/50-60		RS 100	TC	LP	FS1	3/230-400/50	230/50-60	
RS 38	TC	LP	FS1	1/230/50	230/50-60	ID	RS 100	TC	LP	FS1	3/230-400/50	230/50-60	ID
RS 38	TC	LP	FS1	3/230-400/50	230/50-60		RS 100	TC	ST	FS1	3/230-400/50	230/50-60	
RS 38	TC	LP	FS1	3/230-400/50	230/50-60	ID	RS 100	TC	ST	FS1	3/230-400/50	230/50-60	ID
RS 38	TC	ST	FS1	1/230/50	230/50-60		RS 100	TL	LP	FS1	3/230-400/50	230/50-60	
RS 38	TC	ST	FS1	1/230/50	230/50-60	ID	RS 100	TL	LP	FS1	3/230-400/50	230/50-60	ID
RS 38	TC	ST	FS1	3/230-400/50	230/50-60		RS 100	TL	ST	FS1	3/230-400/50	230/50-60	
RS 38	TC	ST	FS1	3/230-400/50	230/50-60	ID	RS 100	TL	ST	FS1	3/230-400/50	230/50-60	ID
RS 38	TL	LP	FS1	1/230/50	230/50-60								
RS 38	TL	LP	FS1	1/230/50	230/50-60	ID	RS 130	TC	LP	FS1	3/230-400/50	230/50-60	
RS 38	TL	LP	FS1	3/230-400/50	230/50-60		RS 130	TC	LP	FS1	3/230-400/50	230/50-60	ID
RS 38	TL	LP	FS1	3/230-400/50	230/50-60	ID	RS 130	TC	ST	FS1	3/230-400/50	230/50-60	
RS 38	TL	ST	FS1	1/230/50	230/50-60		RS 130	TC	ST	FS1	3/230-400/50	230/50-60	ID
RS 38	TL	ST	FS1	1/230/50	230/50-60	ID	RS 130	TL	LP	FS1	3/230-400/50	230/50-60	
RS 38	TL	ST	FS1	3/230-400/50	230/50-60		RS 130	TL	LP	FS1	3/230-400/50	230/50-60	ID
RS 38	TL	ST	FS1	3/230-400/50	230/50-60	ID	RS 130	TL	ST	FS1	3/230-400/50	230/50-60	
RS 38	TL	ST	FS1	3/230-400/50	230/50-60	ID	RS 130	TL	ST	FS1	3/230-400/50	230/50-60	ID
RS 50	TC	LP	FS1	3/230-400/50	230/50-60		RS 190	TC	ST	FS1	3/230-400/50	230/50-60	
RS 50	TC	LP	FS1	3/230-400/50	230/50-60	ID	RS 190	TC	ST	FS1	3/230-400/50	230/50-60	ID
RS 50	TC	ST	FS1	3/230-400/50	230/50-60								
RS 50	TC	ST	FS1	3/230-400/50	230/50-60	ID							
RS 50	TL	LP	FS1	3/230-400/50	230/50-60								
RS 50	TL	LP	FS1	3/230-400/50	230/50-60	ID							
RS 50	TL	ST	FS1	3/230-400/50	230/50-60								
RS 50	TL	ST	FS1	3/230-400/50	230/50-60	ID							

Other versions are available on request



## ▶ PRODUCT SPECIFICATION

### *Burner:*

Monoblock forced draught gas burner with two stage operation, fully automatic, made up of:

- Air suction circuit lined with sound-proofing material
- Fan with reverse curve blades (straight blades on the 190 model) high performance with low sound emissions
- Air damper for air flow setting and butterfly valve for regulating fuel output on 1st and 2nd stage controlled by a servomotor with variable cam
- Starting motor at 2800 rpm, three-phase 400V with neutral, 50Hz (available also single-phase, 230V, 50Hz for the RS 28 and 38 models)
- Combustion head, that can be set on the basis of required output, fitted with:
  - stainless steel end cone, resistant to corrosion and high temperatures
  - ignition electrodes
  - ionisation probe
  - gas distributor
  - flame stability disk
- Minimum air pressure switch stops the burner in case of insufficient air quantity at the combustion head
- Flame control panel, with lock-out pilot light and lock-out reset button
- Electronic control device: STATUS PANEL or LED PANEL
- Burner on/off selection switch
- 1st - 2nd stage manual switch
- Flame inspection window
- Slide bars for easier installation and maintenance
- Protection filter against radio interference
- IP 44 electric protection level.

### Gas train

Fuel supply line, in the MULTIBLOC configuration (from a diameter of 3/4" until a diameter 2") or COMPOSED configuration (from a diameter of DN 65 until a diameter of DN 100), fitted with:

- Filter
- Stabiliser
- Minimum gas pressure switch
- Safety valve
- Valve seal control (for output > 1200 kW)
- One stage working valve with ignition gas output regulator.

### Conforming to:

- 89/336/EEC directive (electromagnetic compatibility)
- 73/23/EEC directive (low voltage)
- 92/42/EEC directive (performance)
- 90/396/EEC directive (gas)
- EN 676 (gas burners).

### Standard equipment:

- 1 gas train gasket
- 1 flange gasket
- 4 screws for fixing the flange
- 1 thermal screen
- 4 screws for fixing the burner flange to the boiler
- Wiring loom fittings for the electrical connection (RS 28 - 38 - 50)
- 2 slide bar extensions (for extended head models and RS 190 model)
- Instruction handbook for installation, use and maintenance
- Spare parts catalogue.

### Available accessories to be ordered separately:

- Head extension kit
- Head length reduction kit
- Continuous ventilation kit
- Sound-proofing box
- LPG kit
- Gas train adapter
- Seal control kit
- Stabiliser spring.



RIELLO S.p.A. - Via degli Alpini, 1 - 37045 LEGNAGO (VR) Italy  
Tel. ++39.0442630111 - Fax ++39.044221980

Internet: <http://www.rielloburners.com> - E-mail: [rburners@rielloburners.com](mailto:rburners@rielloburners.com)



Since the Company is constantly engaged in the production improvement, the aesthetic and dimensional features, the technical data, the equipment and the accessories can be changed.  
This document contains confidential and proprietary information of RIELLO S.p.A.  
Unless authorised, this information shall not be divulged, nor duplicated in whole or in part.