

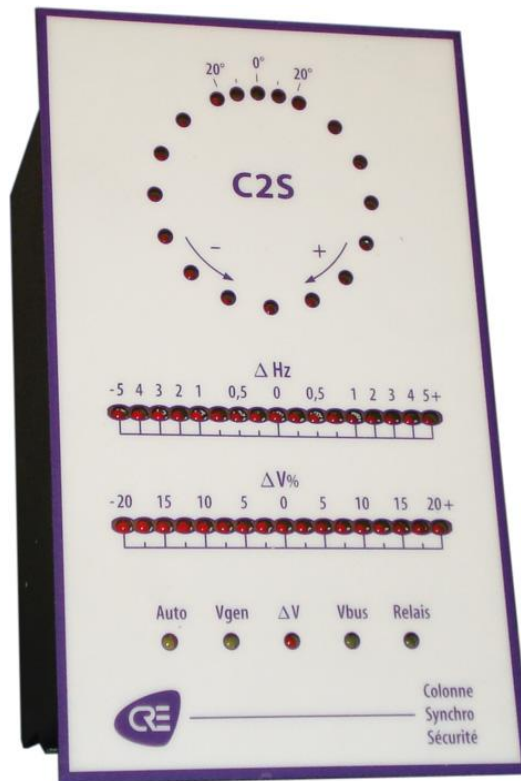

C2S

Technical Documentation



"SYNCHRONISATION AND SAFETY COLUMN"

Part Number:
A25 Z0 9 0004 F-EN
Last Update:
November 2000

1 CRE TECHNOLOGY, INFORMATION NOTE



130 Allée Charles-Victor Naudin
Zone des Templiers – Sophia Antipolis
06410 – BIOT
FRANCE



Phone: +33 492 38 86 82
Fax: +33 492 38 86 83



Website: www.cretechnology.com
Email: info@cretechnology.com



NOTE:

Read this entire manual and all other publications pertaining to the work to be performed before installing, operating, or servicing this equipment. Apply all plant and safety instructions and precautions. Failure to follow instructions can cause personal injury and/or property damage.

Motors, turbines and any other type of generator must be equipped with protections (overspeed, high temperature, low pressure,...depending on the power plant).

Any changes of the normal use of the equipment can cause human and material damage.

For further information, please contact your CRE technology distributor or the After-Sales Service Team.

All CRE Technology products are delivered with one year warranty, and if necessary we will be happy to come on site for product commissioning or troubleshooting. The company also provide specific trainings on our products and softwares.



Technical Support: +33 492 38 86 86 (office hours: 8.30AM-12AM / 2PM-6PM)

Mail: support@cretechnology.com



SKYPE: support-cretechnology.com



INFORMATION

You can download the most up-to-date version of this documentation and different other documentations relating to C2S on our web site:

<http://www.cretechnology.com/>

You can download the most up-to-date version of this documentation and different other documentations relating to C2S on our web site: <http://www.cretechnology.com/>.

TABLE CONTENT

1	CRE TECHNOLOGY, INFORMATION NOTE	2
	TABLE CONTENT	3
2	INTRODUCTION	4
3	OPERATION	5
3.1	PUTTING INTO SERVICE	5
3.2	AUTO/MANUAL MODE.....	5
3.3	AUTHORISING SYNCHRO-CHECK RELAY	5
3.4	MICRO-SHUNTS	6
4	CONFIGURATION - FACTORY SETTINGS	7
4.1	POTENTIOMETERS	7
4.2	MICRO-SHUNTS	7
5	PUTTING INTO SERVICE-CONTROL.....	8
6	EMC PRECAUTION-CE MARK CONFORMITY	9
7	WIRING DIAGRAM.....	10
8	ENVIRONMENT-CHARACTERISTICS	11
9	SIZE	12
10	MOUNTING	13
11	CRE TECHNOLOGY, WHERE TO FIND US.....	14

2 INTRODUCTION

This second generation microprocessor module, created by C.R.E., is a module for manual coupling which integrates a synchronisation column and the syncheck authorisation relay. The synchronisation column allows visualisation of phase, frequency and voltage difference between one or several gensets to be coupled to a bus bar or reference bus. The authorisation relay allows safe coupling only when the conditions meet the requirements of the installation.

This new version of C2S features the following functions:

- ❖ CE mark conformity, thanks to a new electronic and mechanical design
 - ❖ No external DC power supply which is on the generator voltage measure Vgen.
 - ❖ Reduced size allowing use of DIN92 format tools.
 - ❖ Measurement of generator voltage and reference bus in 100, 230 or 400VAC with 3 different references:
 - * For 100 VAC, ordering reference A25Z0.
 - * For 230 VAC, ordering reference A25Z1.
 - * For 400 VAC, ordering reference A25Z2
 - ❖ Display of phase difference between the generator to be coupled and the reference bus by
 - a 18 LEDs synchronoscope (360°).
 - ❖ Display of frequency difference between the generator to be coupled and the reference
 - bus by a 17 LEDs bargraph (+/-5Hz), the frequency set at 50 or 60 Hz.
- Display of voltage difference between the generator to be coupled and the reference
- bus by a 17 LEDs bargraph (+/-20%).
- ❖ Display by LEDs of the following information:
 - * Presence of generator voltage (**VGEN**).
 - * Presence of reference bus voltage (**VBUS**).
 - * Voltage difference fault (**Delta V**).
 - * Synchronisation/coupling in automatic mode (**Auto**).
 - * Closed coupling authorisation relay (**RELAIS**).
- ❖ Coupling authorisation in manual mode by an isolated contact check, frequency and voltage difference).
- ❖ Possibility by microshunt authorise the closure of the circuit breaker if $V_{bus}=0$ and if $V_{generator}$ is between 85% and 115% of $V_{nominal}$.

3 OPERATION

3.1 PUTTING INTO SERVICE

The Synchronisation and Safety Column (C2S) is powered by the generator voltage on Vgen terminals 4 and 5.

WARNING: The module C2S is powered from 60% of nominal generator voltage value, and up to 115% as a maximum. Not damage the C2S, Voltage must not exceed 115%.

3.2 AUTO/MANUAL MODE

The bargraphs and signalling of the C2S module function as follows:

- ❖ In manual mode (terminals 6-7 open), all the displays and functions are in order. The "AUTO" LED is not lit.
- ❖ In automatic mode (terminals 6-7 closed), the synchronoscope and the 2 differential bargraphs (voltmeter and frequency meter) are in order. The "Auto" LED is lit and all the other information LEDs are not in order. The relay will never be activated.

WARNING: The synchronoscope only comes back on line if the frequency difference is less than 0.5Hz.

- ❖ Synchronoscope : When the synchronoscope turn clockwise, the genset is faster than the busbar, so slow down the speed. If any led of the synchronoscope is lit the frequency difference is more than 0,5 Hz and it is displayed on the frequency bargraph.
- ❖ Frequency Bargraph : If the frequency bargraph *Delta* Hz displays negative difference then accelerate the genset.
- ❖ Voltage Bargraph : If the voltage bargraph *Delta* V displays negative difference then raise the genset voltage.

3.3 AUTHORIZING SYNCHRO-CHECK RELAY

The relay authorising manual coupling is activated in the following conditions (all in the same time):

Frequency difference remaining within the limits of +/- 0,1Hz (no adjustment to be made).

Phase difference remaining within the setting limits of the RV1 "Phase difference" potentiometer (from +/- 5° to +/-20°).

Voltage difference remaining within the setting limits of the RV2 "Voltage difference" potentiometer (from +/-2,5% to +/-20%).

Bus and generator voltages greater than 85% and less than 115% of their nominal value.

Bus and generator frequencies contained between 45Hz and 65Hz.

3.4 MICRO-SHUNTS

The micro-shunt JP1 configures the C2S to authorise the closure of the output relay when no voltage is present on the bus and the generator voltage is correct (between 85% and 115% of the nominal value).
The JP2 micro-shunt allows a self-test of all the module's LEDs when the system is powered up.

4 CONFIGURATION - FACTORY SETTINGS

To access potentiometers and micro-shunts, it is necessary to remove the back cover of the module.

WARNING: Check that no voltage is present on the terminal trip before removing the cover.

4.1 POTENTIOMETERS

Note: The RV1 potentiometer is factory configured and should not be altered.

- **RV2 "phase difference" Potentiometer:** This potentiometer enables the adjustment of the allowed phase difference between $\pm 5^\circ$ (fully counter-clockwise) and $\pm 20^\circ$ (fully clockwise).

Factory setting 10° .

- **RV3 "voltage difference" Potentiometer:** This potentiometer enables the adjustment of the allowed voltage difference between $\pm 2.5\%$ (fully counter-clockwise) and $\pm 20\%$ (fully clockwise).

Factory setting 10%.

4.2 MICRO-SHUNTS

- **Micro-shunt JP1:** The micro-shunt JP1 configures the C2S to authorise the closure of the output relay when no voltage is present on the bus and the generator voltage is correct (between 85% and 115% of the nominal value).

WITH: Closure of the relay if $V_{BUS}=0$ or $V_{BUS}=V_{GEN}$

WITHOUT: Closure of the relay only if $V_{BUS}=V_{GEN}$

Factory setting : WITHOUT.

-**Micro-shunt JP2:** The micro-shunt JP2 enables a self-test of all the module's LEDs when the system is powered up.

WITH : Self-test in order

Factory setting : WITHOUT.

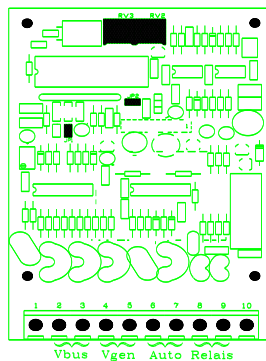

5 PUTTING INTO SERVICE-CONTROL

- Disconnect the wires from the coupling authorisation relay's isolated contact (terminals 8-9), so as to prevent the coupling of the generator with the bus.
- Feed the C2S module with generator voltage V_{GEN} , on terminals 4 and 5. Generator voltage to be coupled and the bus voltage should both be present.
- Check the relationship between the phases applied in V_{GEN} (terminals 4-5) and V_{BUS} (terminals 2-3) on the C2S

WARNING: 2 opposite phases generate a 180° coupling and different phases on V_{GEN} and V_{BUS} generate a +/-120° coupling.

- Check that the voltage presence LEDs for the generator (**V_{GEN}**) and the (**V_{BUS}**) are lit. They light up as soon as their corresponding voltage reaches a level between 85% and 115% of their nominal value. If one of these 2 LEDs is not lit, then the output relay will never be activated.
- The LED "voltage difference fault" (**ΔV**) indicates that the voltage difference between the generator and the bus is greater than the RV2 potentiometer "voltage difference" setting. This difference is displayed on the differential voltmeter. If this LED is lit, the authorisation relay will never be activated.
- The automatic mode LED (**Auto**) indicates that the synchronisation and coupling are carried out by the automatic synchroniser. If this LED is lit, the other information LEDs are inhibited. The voltage and frequency bargraphs and the synchronoscope remain on line. In this mode, the output relay will never be activated.
- The closed coupling authorisation relay LED (**RELAIS**) lights up when the output relay is activated. The relay and this LED remain activated as long as the phase, frequency and voltage differences are

6 EMC PRECAUTION-CE MARK CONFORMITY

The C2S version A25Zx is conformed to European CE mark requirements. Here below some councils to use the C2S.

- Faraday cage effect:

The C2S is painted with a conductive paint. We recommend to maintain surface contact between the C2S casing and the switchboard housing.

If the back cover needs to be removed, replace it and screws must be fully tightened.

For IP65 protection use our CE mark conductive gasket option.

- Equipotentiality : To assure an efficient potential ground line between the C2S and the switchboard, we recommend to connect the switchboard ground direct to the C2S's terminal ground on the back cover (see connection diagram below).

- Shielding connection:

To avoid EM interference we recommend to connect shielding of signals wires on terminals 1 and 10

Note: Use of non-CE mark gasket, do not affect intrinsic EMI immunity of the C2S

7 WIRING DIAGRAM

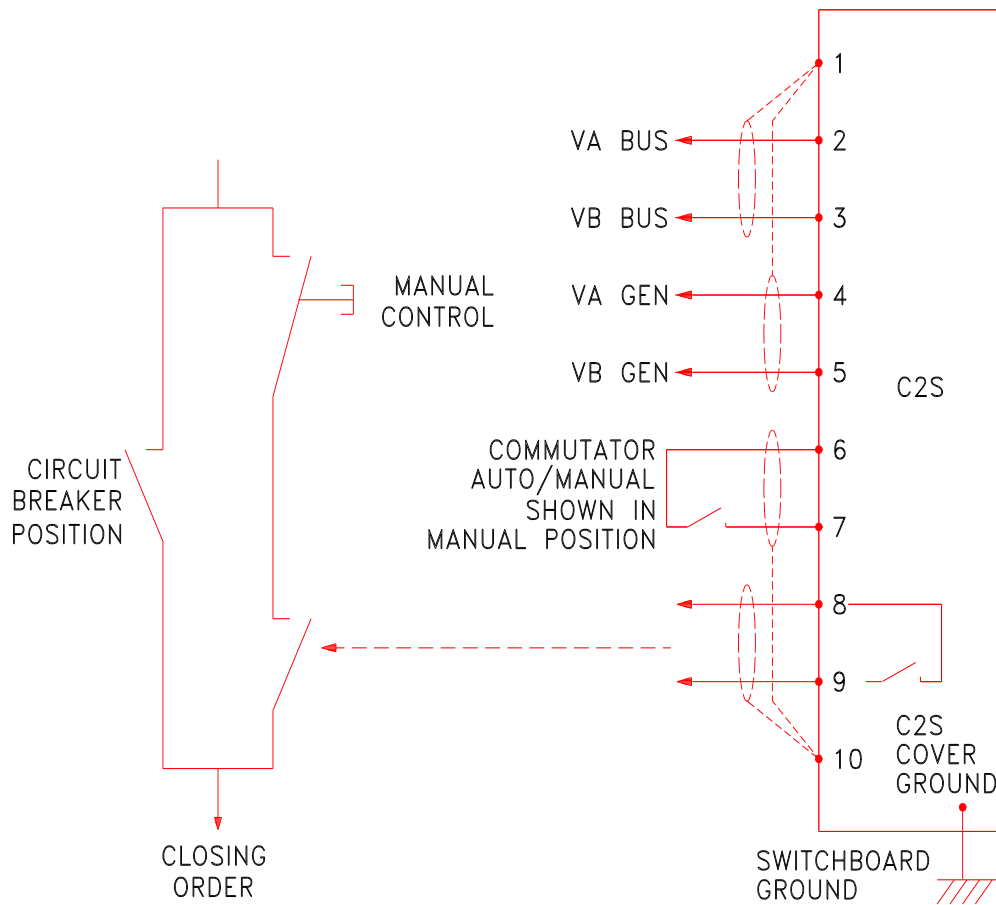

The voltage V_{GEN} of the generator to be coupled is connected by 2 wires on terminals 1 and 2.
The voltage V_{BUS} of the reference bus is connected by 2 wires on terminals 3 and 4.
If the supplying voltages are greater than the C2S nominal inputs, use reducing transformers.

WARNING: Check carefully that the phases connected on the generator voltage are the same as those connected on the reference bus voltage and in the same order. Remember that 2 opposite phases generate a 180° coupling and that different phases on the generator voltage and the bus voltage generate a $\pm 120^\circ$ coupling.

8 ENVIRONMENT-CHARACTERISTICS

Alternative input voltages:

- ❖ Generator measuring voltage (V_{GEN}) and power supply: 50 and 60 Hz (maximum consumption <4VA).

Ordering reference	Measuring range	Voltage max
A25Z0	100V \pm 15%	130V
A25Z1	230V \pm 15%	275V
A25Z2	400V \pm 15%	480V

- ❖ Reference bus measuring voltage (V_{BUS}): 50 and 60 Hz (maximum consumption <0,1VA).

Ordering reference	Measuring range	Voltage max
A25Z0	100V \pm 15%	130V
A25Z1	230V \pm 15%	275V
A25Z2	400V \pm 15%	480V

- ❖ Operating temperature: -25 à +85°C
- ❖ Humidity: Tropic-proof circuits for normal operation in humid conditions. Front panel IP65 Protection.
- ❖ Weight: 0,9 Kg
- ❖ Size - Mounting : see plan in annexe
- ❖ Voltage supply :
- ❖ Alternative voltage on terminals 4 & 5 (V_{gen}), 50 and 60 Hz (maximum consumption <4VA).

Ordering reference	Voltage supply	Voltage max
A25Z0	100V \pm 15%	130V
A25Z1	230V \pm 15%	275V
A25Z2	400V \pm 15%	480V

- ❖ Output relay contact :

Cutting power: 2000VA resistive load
 Nominal voltage /Maximal cutting voltage 250VCA/440VCA
 Nominal cutting current 8A

WARNING: Differential voltage bargraph is flashing when one or both of the voltage is out of ranges above and not at zero.

9 SIZE

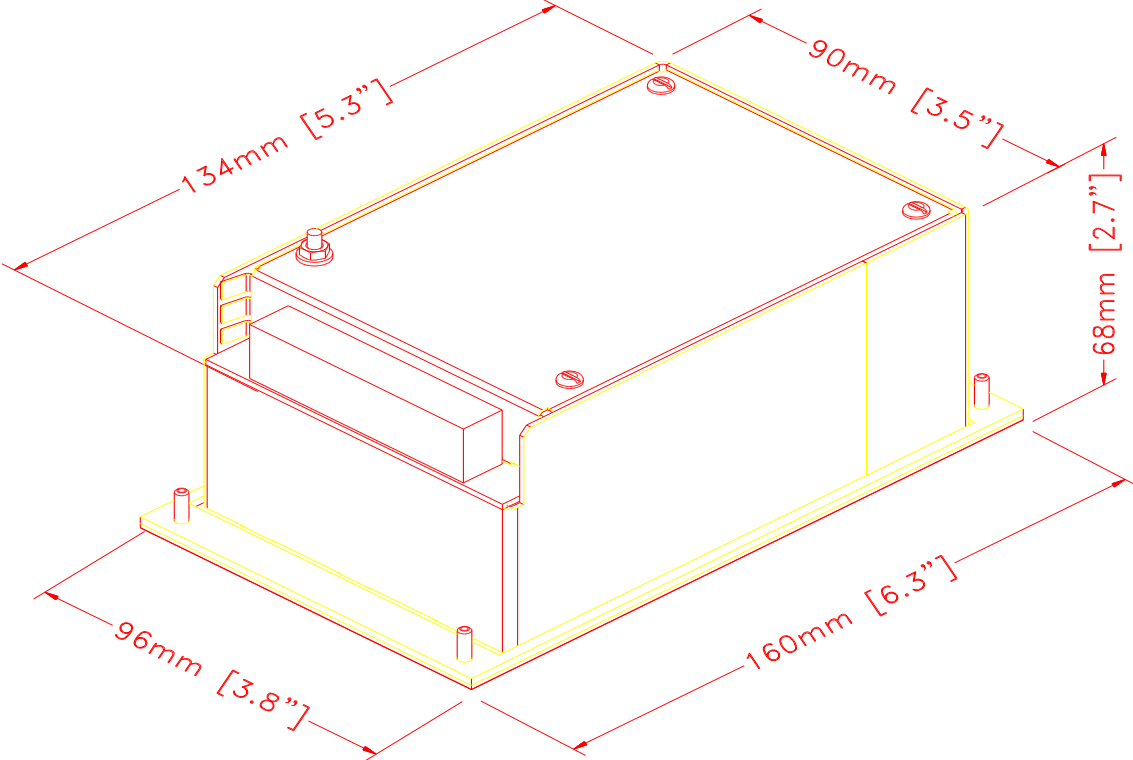

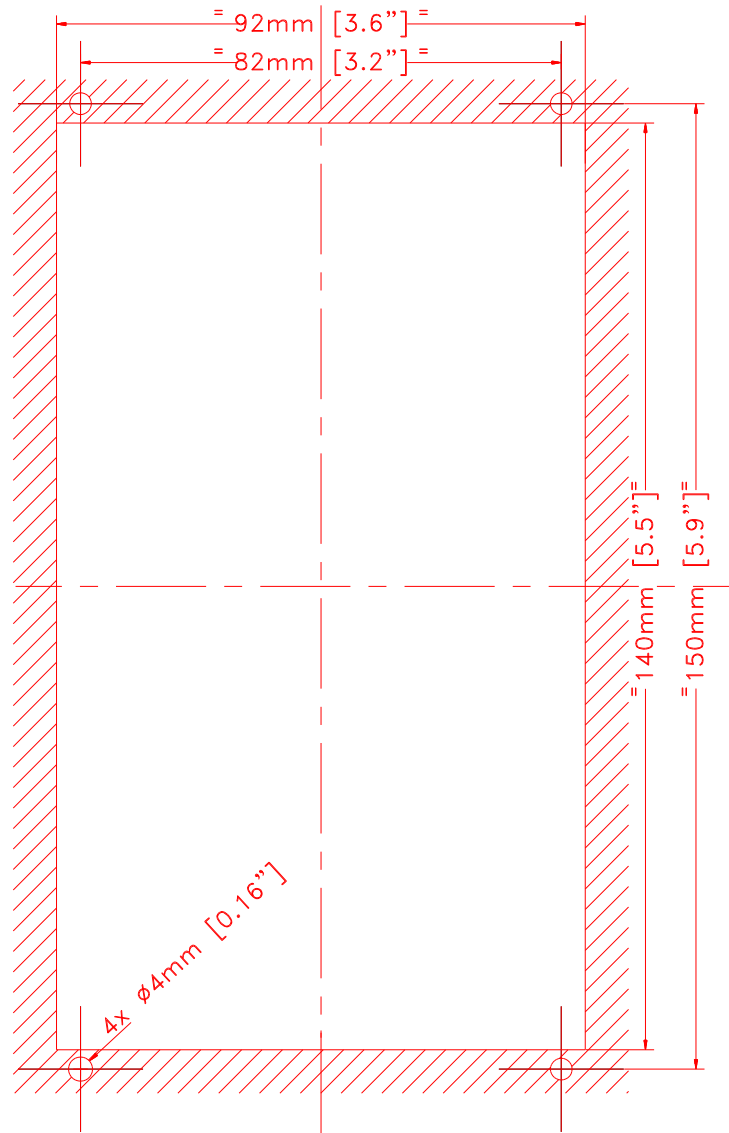

11 CRE TECHNOLOGY, WHERE TO FIND US



130, Allée Victor Naudin
Zone des Templiers
Sophia-Antipolis
06410 Biot
FRANCE



Phone: +33 (0)4 92 38 86 82
Fax: +33 (0)4 92 38 86 83



Website: www.cretechnology.com
Email: info@cretechnology.com



Technical support: +33 (0)4 92 38 86 86 (office hours: 8.30AM-12AM / 2PM-6PM)

Email: support@cretechnology.com



SKYPE: support-cretechnology.com

SARL au Capital de 300.000 Euros - RCS Antibes: 7488 625 000 15 N°TVA FR54 488 625 583

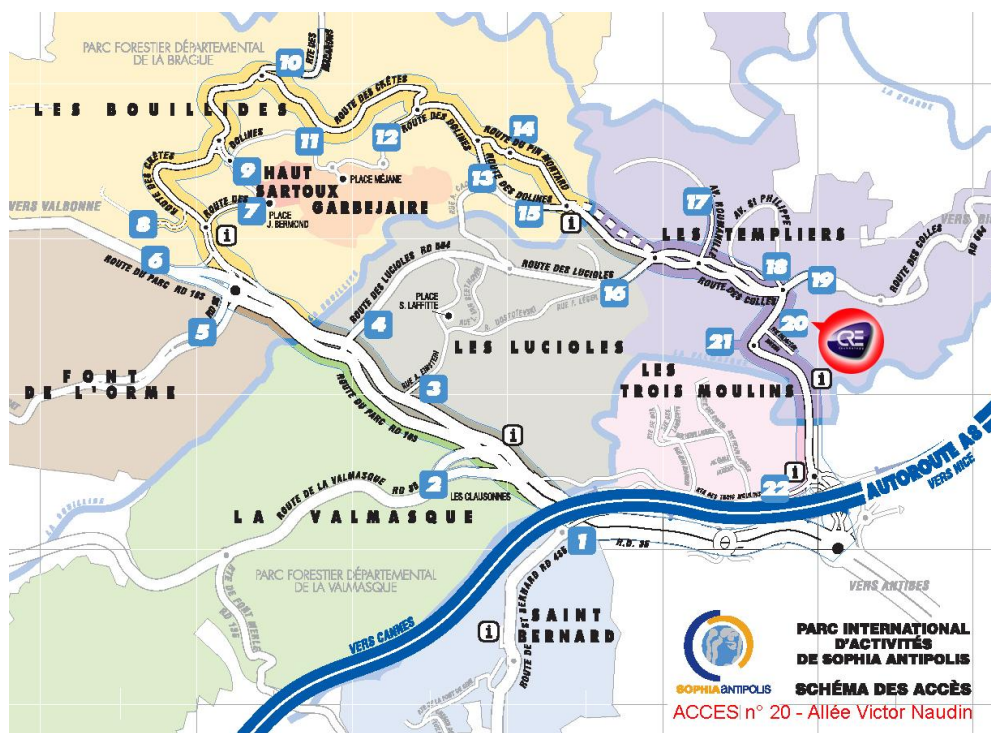

ACCESS TO CRE TECHNOLOGY

Found our entire distributors list into the world, www.cretechnology.com tab "DISTRIBUTEURS"

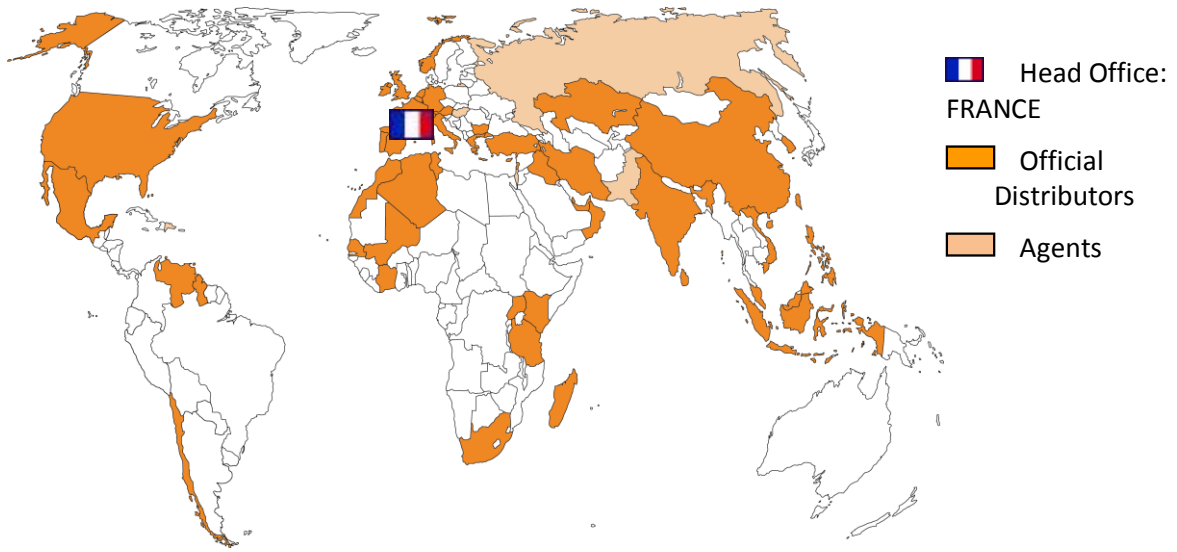

CRE TECHNOLOGY DISTRIBUTORS

CRE Technology retains all copyrights in any text, graphic images, and software owned by CRE Technology and hereby authorizes you to electronically copy documents published herein solely for the purpose of transmitting or viewing the information.

© copyright
all rights reserved