

ACGEN2.0 - ICGEN2.0 - TCGEN2.0 MONITOR INSTRUCTIONS MANUAL



CRE TECHNOLOGY believes that all information provided herein is correct and reliable and reserves the right to update at anytime. CRE TECHNOLOGY does not assume any responsibility for its use.

TABLE OF CONTENT

1.	GENERAL REQUIREMENT & INSTALLATION	4
1.1	General notes.....	4
1.2	Product Label and Rating plate	4
1.3	Hardware settings	5
1.4	Electrical installations	6
1.5	Connections.....	7
1.5.1	ACGEN2.0.....	7
1.5.3	TCGEN2.0.....	9
1.6	Operation mode.....	10
1.6.1	Automatic mode	10
1.6.2	Manual mode.....	10
1.6.3	Test mode	10
1.6.4	Reset mode.....	11
1.6.5	Alarms.....	11
1.6.6	First installation	11
1.7	Equipment Overview	12
1.7.1	ACGEN2.0.....	12
1.7.2	ICGEN2.0.....	13
1.7.3	TCGEN2.0.....	14
1.8	Display pages	15
1.8.1	Navigation diagram	15
1.8.2	Display pages – Navigation cursors.....	16
1.8.3	Display pages - Mains.....	17
1.8.4	Display pages – Genset.....	18
1.8.5	Display pages – Engine / Only for ACGEN2.0 & TCGEN2.0.....	19
1.8.6	Display pages – Fuel / Only for ACGEN2.0 & TCGEN2.0.....	20
1.8.7	Display pages – OpEx / Only for ACGEN2.0 & TCGEN2.0.....	21
1.8.8	Display pages – Events log	21
1.8.9	Display pages – System	21
1.8.10	Display pages – Start & stop / Only for ACGEN2.0 & TCGEN2.0.....	22
1.8.11	Display pages – Fast setup	23
2.	PROGRAMMATION MENUS	24
2.9	Navigation chart – Global Setup: ICGEN2.0	24
2.10	Navigation chart – Global Setup: ACGEN2.0	25
2.11	Navigation chart – Global Setup: TCGEN2.0	26
2.12	Navigation instructions.....	27
2.13	M1 – Mains Setup / Only for ICGEN2.0 & TCGEN2.0.....	28
2.14	M2 – Alternator setup	29

2.15	M3 – Engine setup	30
2.15.1	M3.1 - Starting setup / Only for ACGEN2.0 & TCGEN2.0	30
2.15.2	M3.2 - Stop setup / only for ACGEN2.0 & TCGEN2.0	31
2.15.3	M3.3 - Preheat setup / only for ACGEN2.0 & TCGEN2.0	31
2.15.4	M3.4 - Fuel setup / only for ACGEN2.0 & TCGEN2.0	32
2.15-5	M3.5 – Oil pressure setup/ only for ACGEN2.0 & TCGEN2.0	33
2.15-6	M3.6 – Temperature setup / only for ACGEN2.0 & TCGEN2.0	33
2.15-7	M3.7 – Battery setup / only for ACGEN2.0 & TCGEN2.0	33
2.15-8	M3.8 – Service setup/ only for ACGEN2.0 & TCGEN2.0	34
2.15–9	M3.9 – OpEx management/ only for ACGEN2.0 & TCGEN2.0	34
2.15-10	M3.10 – Canbus setup / only for ACGEN2.0 & TCGEN2.0	36
2.15-11	M3.11 – Choke setup / only for ACGEN2.0 & TCGEN2.0	37
2.16	M4 – General setup	38
2.16-10	M4.1 – Display setup	38
2.16-11	M4.2 – Clock setup	38
2.16-12	M4.3 - Test setup	39
2.16-13	M4.4 – Security setup	40
2.17	M5 – Alarms list	40
2.17.1	M5 – Alarms default parameters	42
2.17-2	M5 – Alarms description	43
2.17-3	M6 - Special functions	44
2.17-4	M6.1 – SCR/ only for ICGEN2.0 & TCGEN2.0	44
2.17-5	M6.2 – Start by mains kW / only for ICGEN2.0 & TCGEN2.0	45
2.17-6	M6.3 – Dummy load / only for ICGEN2.0 & TCGEN2.0	46
2.17-7	M6-4 Hours / Only for ICGEN2.0	46
2.18	M8 – I/O setup	47
2.18-1	M8.1 - Input setup	47
2.18-2	M8.2 – Output setup	48
2.18-3	M8.3 - Input type	49
2.18-4	M8.4 – Output type	50
2.18-5	M8.5 – Calibration	50
2.18-6	M8.7 – Expansion/ Only for TCGEN2.0	51
APPENDIX	52
	Appendix A: Fuel sensor curves / Only for ACGEN2.0 & TCGEN2.0	52
	Appendix B: Oil pressure sensor curves / Only for ACGEN2.0 & TCGEN2.0	53
	Appendix C: Temperature sensor curves / Only for ACGEN2.0 & TCGEN2.0	54

1. GENERAL REQUIREMENT & INSTALLATION

1.1 General notes

WARNING!

- Carefully read the manual before the installation or use.
- This equipment is to be installed by qualified personnel, complying to current standards, to avoid damages or safety hazards.
- Before any maintenance operation on the device, remove all the voltages from measuring and supply inputs and short-circuit the CT input terminals.
- Products illustrated herein are subject to alteration and changes without prior notice.
- Technical data and descriptions in the documentation are accurate, to the best of our knowledge, but no liabilities for errors, omissions or contingencies arising there from are accepted.
- A circuit breaker must be included in the electrical installation of the building. It must be installed close by the equipment and within easy reach of the operator. It must be marked as the disconnecting device of the equipment: IEC /EN 61010-1 § 6.12.2.1.
- Clean the instrument with a soft dry cloth; do not use abrasives, liquid detergents or solvents.

1.2 Product Label and Rating plate

General identifications of each unit are traced on the plate below and placed on the controller.

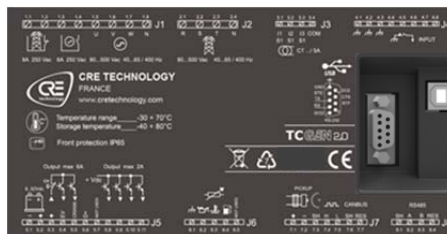
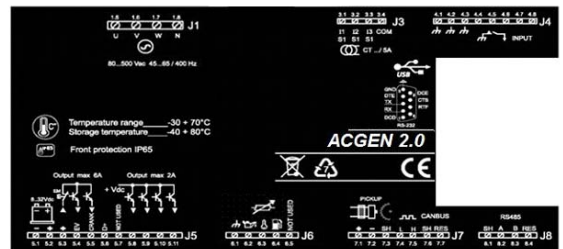
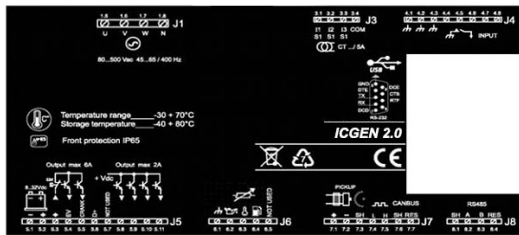

NOTE: Inform the manufacturer the general identification data reported on the label before asking for technical specifications or informations about the equipment

1.3 Hardware settings

GENERAL CHARACTERISTICS		ACGEN2.0	ICGEN2.0	TCGEN2.0
Rated voltage Vdc	12Vdc (24Vdc)	*	*	*
Allowed Vdc	from 6Vdc to 33Vdc	*	*	*
Rated voltage Vac	400 Vac	*	*	*
Allowed Vac	Up to 500 Vac	*	*	*
Allowed frequency	From 45 to 75 Hz	*	*	*
Max consumption with backlight	250 mA	*	*	*
Temperature range	-30 °C + 70 °C (electric)	*	*	*
	-20 °C + 70 °C (display)	*	*	*
	-30 °C + 80 °C (storage)	*	*	*
DISPLAY	128x64 px ; 66x33mm	*	*	*
DIGITAL INPUTS				
N°	5	*	*	
STATIC OUTPUT				
N°	6 (2x4A ; 4x2A)	*	*	*
SERIAL COMMUNICATION INTERFACE				
Interface type	Serial RS -232	*	*	*
Cable length	< 3 m	*	*	*
Baud rate	Up to 115200 bps	*	*	*
Interface type	Serial RS485	*	*	*
Baud rate	Up to 115200 bps	*	*	*
CONTACTORS RELAYS				
N° outputs	2	*	*	*
Type of contacts	1x N.O. genset contactor - 1x N.C. mains contactor	*	*	*
Contact capacity	8 A / 250 VAC	*	*	*
LOAD CURRENTS INPUT				
N°	3	*	*	*
Measure range	Up to 5A	*	*	*
Precision	< 1% F.S. + 1 digit	*	*	*
VOLTAGE INPUTS				
N°	8	*	*	*
Input type	Resistive coupling	*	*	*
Rated voltage	230 Vac (L-N) - 400 Vac (L-L)	*	*	*
Measure range	TRMS from 0 to 300 Vac (L-N) - from 0 to 500 Vac (L-L)	*	*	*
Precision	< 1% F.S. + 1 digit	*	*	*
ACTIVE POWER MEASURE				
Measure type	Instant power integration	*	*	*
Precision	< 1%	*	*	*

STANDARD REFERENCE
EN55011
EN55016-2-1
EN55016-2-3
EN60068-2-1
EN60068-2-2
EN60068-2-27
EN60068-2-30
EN60068-2-6
EN61000-4-2
EN61000-4-3
EN61000-4-4
EN61000-4-5
EN61000-4-6
EN61000-4-8
EN61000-6-2
EN61000-6-4
HBV Bureau Veritas NR320

1.4 Electrical installations

Warning! before inserting the plugs make sure that the connections strictly comply with the wiring diagram below. For more informations about programmable inputs/outputs, see par. 2-10.

WARNING: All these terminals are not used for IC & ACGEN

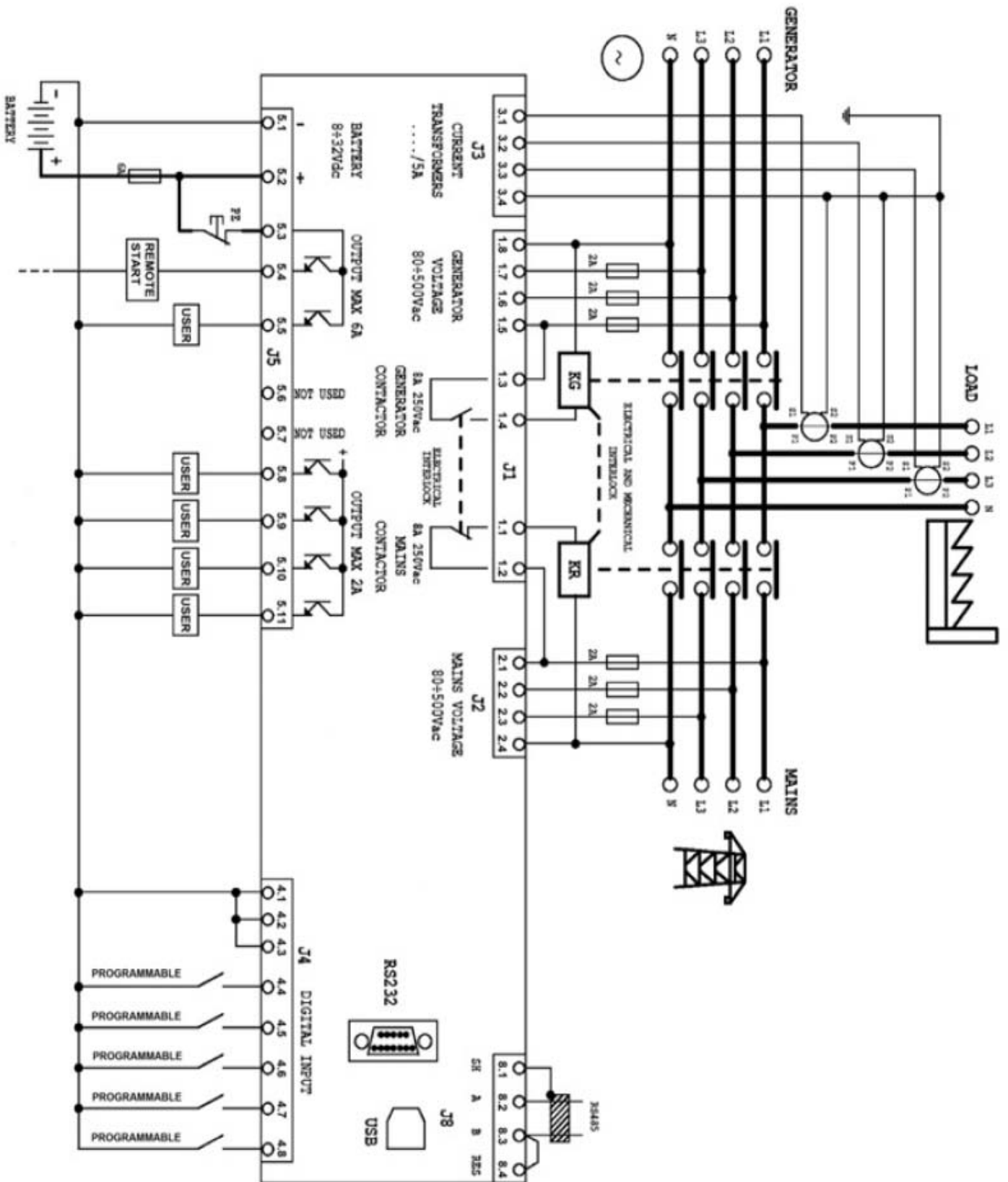

1.5 Connections

1.5.1 ACGEN2.0

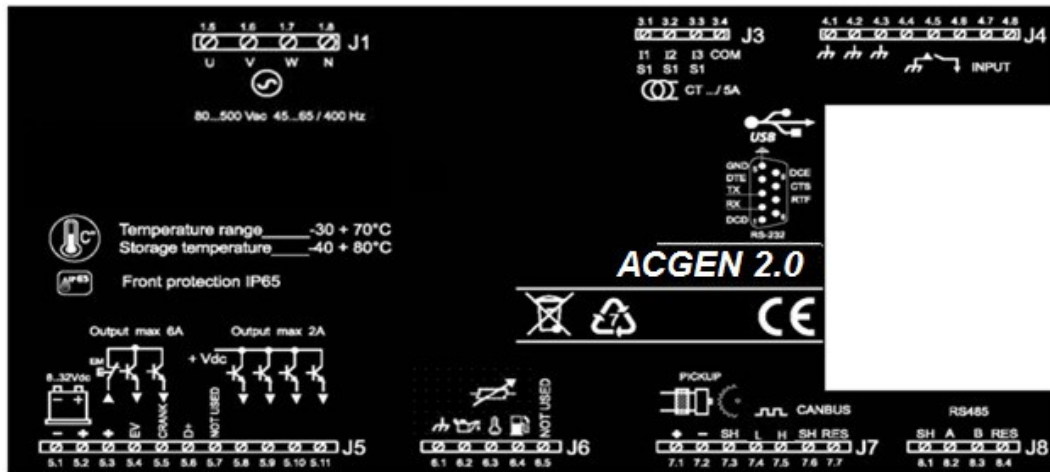

J1 – Genset AC voltage and contactors

- 1.1 – Not used
- 1.2 – Not used
- 1.3 – Not used
- 1.4 – Not used
- 1.5 - Genset voltage phase 1
- 1.6 - Genset voltage phase 2
- 1.7 - Genset voltage phase 3
- 1.8 - Neutral

J3 – Genset AC current

- 3.1 - Genset current I1
- 3.2 - Genset current I2
- 3.3 - Genset current I3
- 3.4 CT common

J9 – Digital Inputs

- 4.1 - Gnd
- 4.2 - Gnd
- 4.3 - Gnd
- 4.4 – Programmable digital input (default - Low coolant level)
- 4.5 – Programmable digital input (default – High engine temperature D)
- 4.6 – Programmable digital input (default – Remote start)
- 4.7 – Programmable digital input (default – Remote stop)
- 4.8 – Programmable digital input (default – Low oil pressure D)

J5 – Supply and Outputs

- 5.1 - Battery negative
- 5.2 - Battery positive
- 5.3 - Common positive for fuel valve and start output (Default - Emergency stop alarm input)
- 5.4 - Fuel valve output
- 5.5 - Start engine output
- 5.6 - Battery charger alternator output (D+)
- 5.7 - Not used
- 5.8 - Programmable output (default – Global alarm #1)
- 5.9 – Programmable output (default – Glow plugs)
- 5.10 – Programmable output (default – Siren)
- 5.11 – Programmable output (default – Electro solenoid)

J6 – Digital / Analog inputs

- 6.1 - Gnd
- 6.2 - Oil pressure digital / analog (programmable, default – Low oil pressure digital)
- 6.3 – High engine temperature digital / analog (programmable, default – High engine temperature digital)
- 6.4 – Fuel level percentage digital / analog (programmable, default – Fuel level percentage analog)
- 6.5 – Not used

J7 – Rpm and Canbus

- 7.1 - Pickup input positive
- 7.2 - Pickup input negative
- 7.3 - Pickup shield
- 7.4 - Canbus Low
- 7.5 - Canbus High
- 7.6 - Canbus
- 7.7 - Canbus termination resistor (bridge with J7 7.5)

J8 – RS485 port

- 1- Shield
- 2- A
- 3- B
- 4 – Termination resistor

RS232 - Communication ports

- RS232 - connection of a remote device

1.5.2 ICGEN2.0

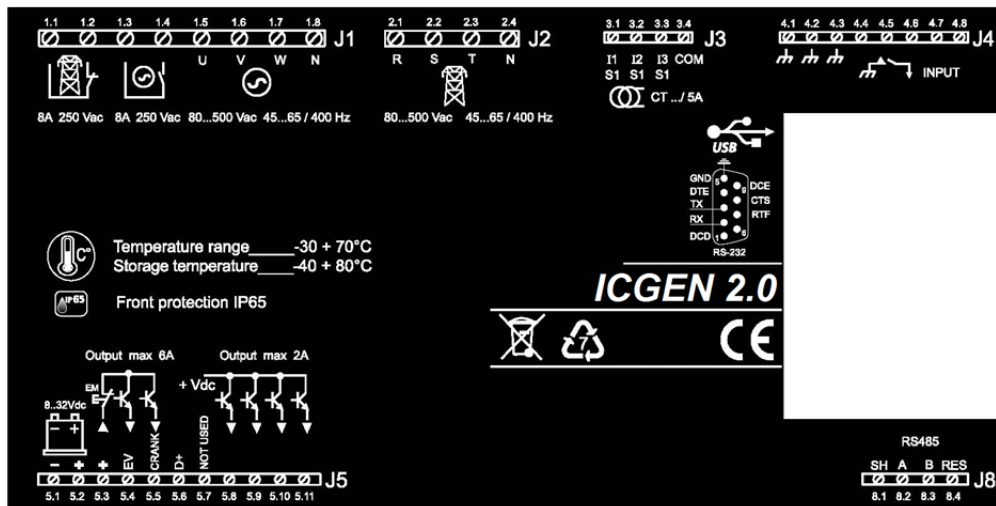

J1 – Genset AC voltage and contactors

- 1.1 - Mains contactor output (NC)
- 1.2 - Mains contactor output (NC)
- 1.3 - Genset contactor output (NO)
- 1.4 - Genset contactor output (NO)
- 1.5 - Genset voltage phase 1
- 1.6 - Genset voltage phase 2
- 1.7 - Genset voltage phase 3
- 1.8 - Neutral

J2 – Mains AC voltage

- 2.1 - Mains voltage phase 1
- 2.2 - Mains voltage phase 2
- 2.3 - Mains voltage phase 3
- 2.4 - Neutral

J3 – Genset AC current

- 3.1 - Genset current I1
- 3.2 - Genset current I2
- 3.3 - Genset current I3
- 3.4 – CT common

J4 – Digital Inputs

- 4.1 - Gnd
- 4.2 - Gnd
- 4.3 - Gnd
- 4.4 - Programmable digital input (default – None)
- 4.5 - Programmable digital input (default – Ground protection)
- 4.6 - Programmable digital input (default – Remote start)
- 4.7 - Programmable digital input (default – Remote stop)
- 4.8 - Programmable digital input (default – None)

J5 – Supply and Outputs

- 5.1 - Battery negative
- 5.2 - Battery positive
- 5.3 - Common positive for the relay outputs
- 5.4 - Programmable output (default – Start)
- 5.5 - Programmable output (default – Faulty start)
- 5.6 - Not used
- 5.7 - Not used
- 5.8 - Programmable output (default – Global alarm #1)
- 5.9 - Programmable output (default – Auto mode)
- 5.10 - Programmable output (default – Manual mode)
- 5.11 - Programmable output (default – Sirent)

J8 – RS485 port

- 1- Shield
- 2- A
- 3- B
- 4 – Termination resistor

RS232 - Communication ports

RS232 - connection of a remote device

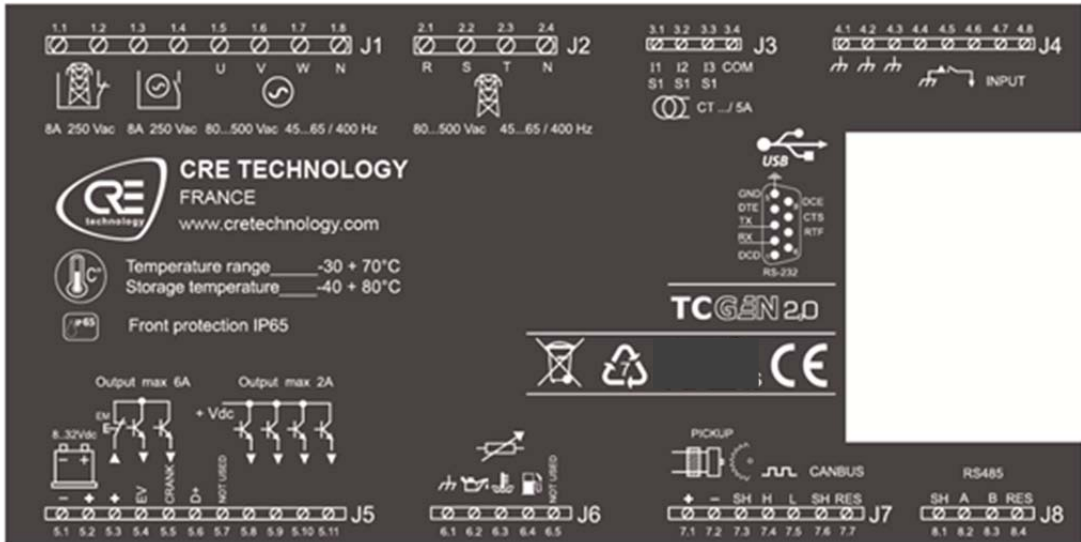

J1 – Genset AC voltage and contactors

- 1.1 - Mains contactor output (NC)
- 1.2 - Mains contactor output (NC)
- 1.3 - Genset contactor output (NO)
- 1.4 - Genset contactor output (NO)
- 1.5 - Genset voltage phase 1
- 1.6 - Genset voltage phase 2
- 1.7 - Genset voltage phase 3
- 1.8 - Neutral

J2 – Mains AC voltage

- 2.1 - Mains voltage phase 1
- 2.2 - Mains voltage phase 2
- 2.3 - Mains voltage phase 3
- 2.4 - Neutral

J3 – Genset AC current

- 3.1 - Genset current I1
- 3.2 - Genset current I2
- 3.3 - Genset current I3
- 3.4 - CT common

J4 – Digital inputs

- 4.1 - Gnd
- 4.2 - Gnd
- 4.3 - Gnd
- 4.4 – Programmable digital input (default - Low coolant level)
- 4.5 – Programmable digital input (default – High engine temperature D)
- 4.6 – Programmable digital input (default – Remote start)
- 4.7 – Programmable digital input (default – Remote stop)
- 4.8 – Programmable digital input (default – Low oil pressure D)

J5 – Supply and Outputs

- 5.1 - Battery negative
- 5.2 - Battery positive
- 5.3 - Common positive for fuel valve and start output (Default - Emergency stop alarm input)
- 5.4 - Fuel valve output
- 5.5 - Start engine output
- 5.6 - Battery charger alternator output (D+)
- 5.7 - Not used
- 5.8 - Programmable output (default – Global alarm #1)
- 5.9 – Programmable output (default – Glow plugs)
- 5.10 – Programmable output (default – Siren)
- 5.11 – Programmable output (default – Electro solenoid)

J6 – Digital / Analog inputs

- 6.1 - Gnd
- 6.2 - Oil pressure digital / analog (programmable, default – Low oil pressure analog)
- 6.3 – High engine temperature digital / analog (programmable, default – High engine temperature analog)
- 6.4 – Fuel level percentage digital / analog (programmable, default – Fuel level percentage analog)
- 6.5 – Not used

J7 – Rpm and Canbus

- 7.1 - Pickup input positive
- 7.2 - Pickup input negative
- 7.3 - Pickup shield
- 7.4 - Canbus Low
- 7.5 - Canbus High
- 7.6 - Canbus
- 7.7 - Canbus termination resistor (bridge with J7-7.5)

J8 - RS485 port

- 1- Shield
- 2- A
- 3- B
- 4- Termination resistor

RS232 - Communication ports

RS232 - connection of a remote device

1.6 Operation mode

1.6.1 Automatic mode

ACGEN2.0:

The engine automatically starts in case of remote start input or test activation (with automatic management of KG, if one output is programmed as KG ON), the engine is stopped when the remote start is removed or at the end of the test procedure. During the starting phase it is possible to stop the engine with the STOP button. At the end of this phase the button is disabled. Use the RESET button to stop the engine. Push the AUT button to select this functioning mode.

ICGEN2.0:

Push the AUT button to select this functioning mode.

In case of mains failure the remote start output (J5.4) is activated and is de-activated in the presence of the same.

This is the standard logic. It's also possible to activate the remote start output in special conditions. For more informations see the special functions menu M6.

TCGEN2.0:

The engine automatically starts in case of mains failure (or out of limits) and stops in the presence of the same, with automatic management of KG and KR. During the starting phase it is possible to stop the engine with the STOP button. At the end of this phase the button is disabled. Use the RESET button to stop the engine. Push the AUT button to select this functioning mode.

1.6.2 Manual mode

ACGEN2.0:

The engine can be started and stopped manually by pressing start and stop key buttons; it is also possible to use the test button to start the engine for the programmed time. Push the MAN button to select this functioning mode.

ICGEN2.0:

In this operative mode, to turn-on the generator (activating the remote start output) you must press KG button. With engine running, you can manually command the transfer switching with KG and KR buttons. KR, besides transferring the load on mains side, turns off the generator. Pressing the KR button, KG is opened and the remote start output is deactivated immediately.

TCGEN2.0:

The engine can be started and stopped manually by pressing start and stop key buttons; load switching on mains and generator is managed using buttons KG and KR. Push the MAN button to select this functioning mode.

1.6.3 Test mode

ACGEN2.0:

Manual test: Press the TEST button: the engine starts immediately to test the genset for a programmable time. If activated during AUT mode, the engine will not be stopped at the end of the timer if remote start input is active. Disabling the test (or after the test time), the controller returns to the previous operation mode. Push the TEST button to select this functioning mode.

Automatic test: If you programmed an automatic test, it will run only if you are in automatic mode.

ICGEN2.0:

Manual test: Press the TEST button: the remote start output is activated to test the genset for a programmable time.

a) If activated during MAN mode, the load switching can be controlled only by KG and KR buttons, even if the mains is faulty. Disabling the test (or after the test time), the controller returns to the previous operation mode.

b) If activated during the AUT mode, the test can be made with or without load, depending on the programming of the test setup (see menu M3).

Automatic test: If you programmed an automatic test (see menu M3), it will run only if you are in automatic mode. The test can be made with or without load, depending on the programming of the test setup (see menu M3).

TCGEN2.0:

Manual test: Press the TEST button: the engine starts immediately to test the genset for a programmable time. If activated during AUT mode, in absence of mains TCGEN2.0 switches the load to the generator. If activated during MAN mode, the load switching can be controlled only by KG and KR buttons, even if the mains is faulty. Disabling the test (or after the test time), the controller returns to the previous operation mode. Push the TEST button to select this functioning mode.

Automatic test: If you programmed an automatic test (see par 2-6.3), it will run only if you are in automatic mode.

1.6.4 Reset mode

ACGEN2.0:

The engine cannot work. If you select Reset mode, the alarms are reset and the engine stops immediately if it is working. If the cause of the alarm remains, it is not possible to reset the alarm. Push the RESET button to select this functioning mode.

ICGEN2.0:

The remote start output cannot be activated. If the mains is available it is connected to the load. If you select Reset mode, the alarms are reset and the remote start output is deactivated. If the cause of the alarm remains, the cause is still present. Push the RESET button to select this functioning mode.

TCGEN2.0:

The engine cannot work. If the mains is available it is connected to the load. If you select Reset mode, the alarms are reset and the engine stops immediately if it is working. If the cause of the alarm remains, it is not possible to reset the alarm. Push the RESET button to select this functioning mode.

1.6.5 Alarms

In case of alarm, the display shows its description. If more different alarms are detected, they appear individually in sequence. For each alarm it is available a message that can help to identify the source of the problem. The alarm reset can be made by pressing the RESET button; by this, the alarm is deleted and the TCGEN2.0 goes in Reset mode, preventing accidental generator starting attempts. If the alarm, after reset, still remains on the display, the cause of the alarm is not removed.

1.6.6 First installation

At power on, the ICGEN2.0/ACGEN2.0/TCGEN2.0 goes automatically to Reset mode. The ICGEN2.0/ACGEN2.0/TCGEN2.0 can be powered either by 12 or 24Vdc, but it needs proper setting of maximum and minimum battery voltage in the "battery setup" menu; if it is not properly set, you will have a warning about the battery voltage. You must set or verify menu parameters about ALTERNATOR (CT ratio, type of connection, rated voltage and frequency) and the Starting Menu inside "Engine setup", according to the type of engine used.

1.7 Equipment Overview

1.7.1 ACGEN2.0

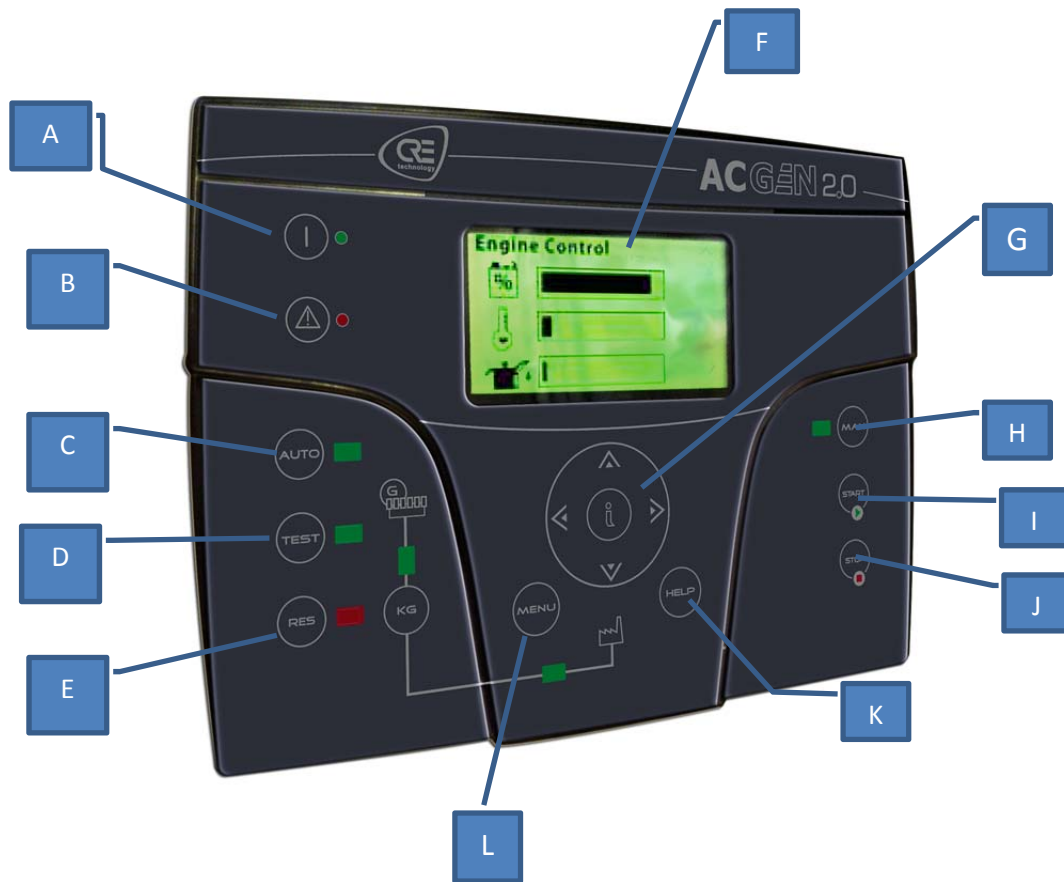

POS.	NAME	DESCRIPTION
A	Battery state led	It turns on when the board is supplied.
B	General alarm led	It turns on if an alarm enabled as global alarm #1 is active
C	AUT	Button to select the automatic mode.
D	TEST	Button to select the test mode.
E	RESET	To activate reset/OFF mode. In this operative mode the engine is stopped without cooling and the alarms are deleted. If the cause of the alarm persists, it's not possible to delete it in reset/OFF mode.
F	Display	Backlighted display shows all functions, measures and alarms about the generator. Automatically the backlight turns off, and it turns on again when you press a button.
G	Navigation drive	Navigation drive composed by 4 arrows to scroll through the pages (left and right arrows) and increase or decrease the parameters inside the programming menus. It contains also a special button "i", to select an element on the screen or edit a parameter and confirm the new value. See paragraph 1-8.1 for more informations about the navigation through the display pages, and paragraph 2-2 for more informations about the navigation through the menus.
H	MAN	Button to select the manual mode.
I	START	To start the generator. Active only in manual mode.
J	STOP	To stop the generator immediately. Active only in manual mode.
K	Help	It permits you to better understand the parameters and symbols in the actual page.
L	Menu	To enter the programming menu. Inside the menus, it's used as a button "back" or "esc".

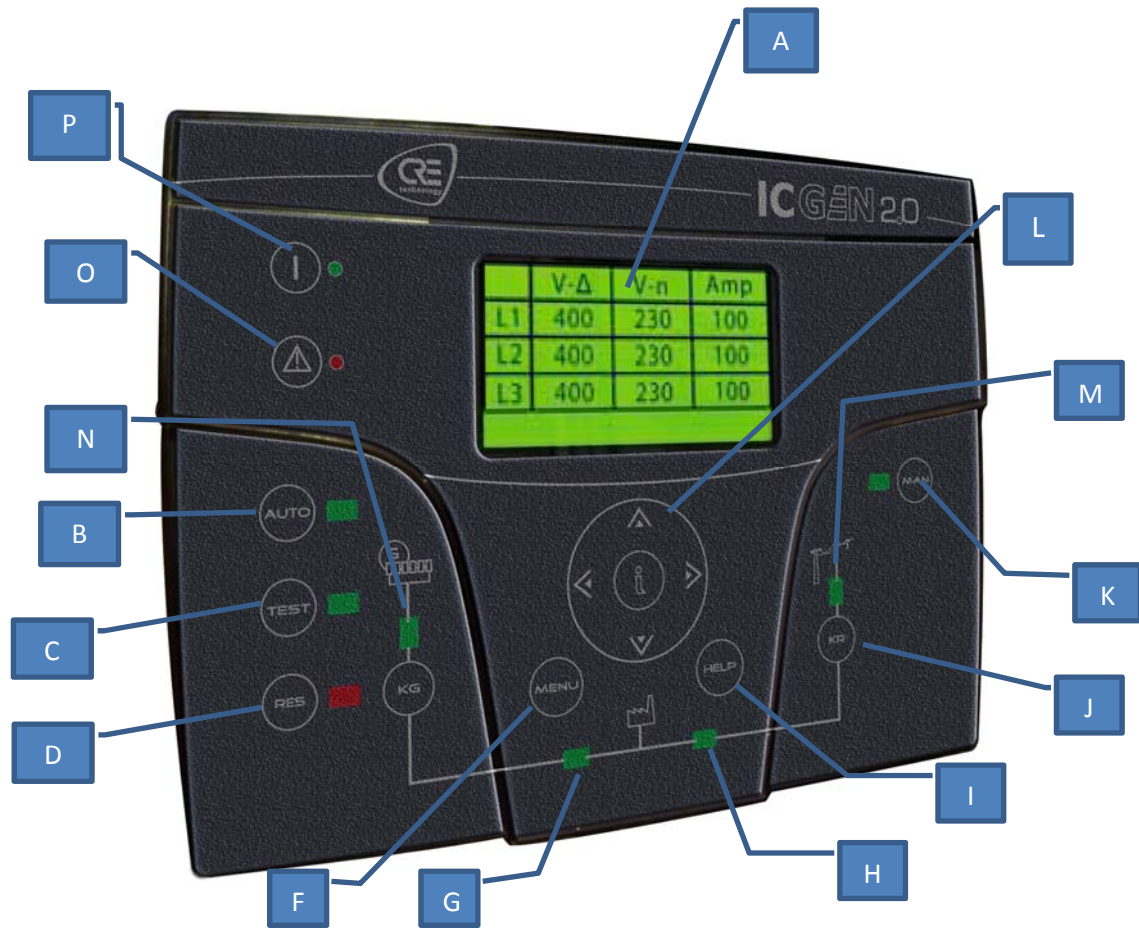

POS.	NAME	DESCRIPTION
A	Display	Backlighted display that shows all functions, measures and alarms about the generator and the mains. Automatically the backlight turns off, and it turns on again when you press a button.
B	AUT	Button to select the automatic mode.
C	TEST	Button to select the test mode.
D	RESET	To activate reset/OFF mode. In this operative mode the remote start output is deactivated and the alarms are deleted. If the cause of the alarm persists, the alarm will appear again.
E	KG	Key control to activate the remote start output (only in manual mode). In manual test mode, this button permits to manage the generator contactor.
F	Menu	To enter the programming menu. Inside the menus, it's used as a button "back" or "esc".
G	KG state led	Led that indicates if KG is closed (led on) or open (led off).
H	KR state led	Led that indicates if KR is closed (led on) or open (led off).
I	Help	From the main page of the menu, it permits to go directly to the active alarms page, if at least one alarm is present.
J	KR	Key control to deactivate the remote start output (only in manual mode). If it's pressed and released quickly, it deactivates the output after the cooling time; if it's kept pressed for 3 seconds, it deactivates the output immediately. In manual test mode, this button permits to manage the mains contactor.
K	MAN	Button to select the manual mode.
L	Navigation drive	Navigation drive composed by 4 arrows to scroll through the pages (left and right arrows) and increase or decrease the parameters inside the programming menus. It contains also a special button "i", to select an element on the screen or edit a parameter and confirm the new value. See paragraph 1.8.1 for more informations about the navigation of the display pages, and paragraph 2-2 for more informations about the navigation through the menus.
M	Mains state led	It shows if the mains is within limits (led on) or not (led off).
N	Generator state led	It shows if the generator is within limits (led on) or not (led off).
O	General alarm led	It turns on if an alarm enabled as global alarm 1 is present.
P	Battery state led	It turns on when the board is supplied.

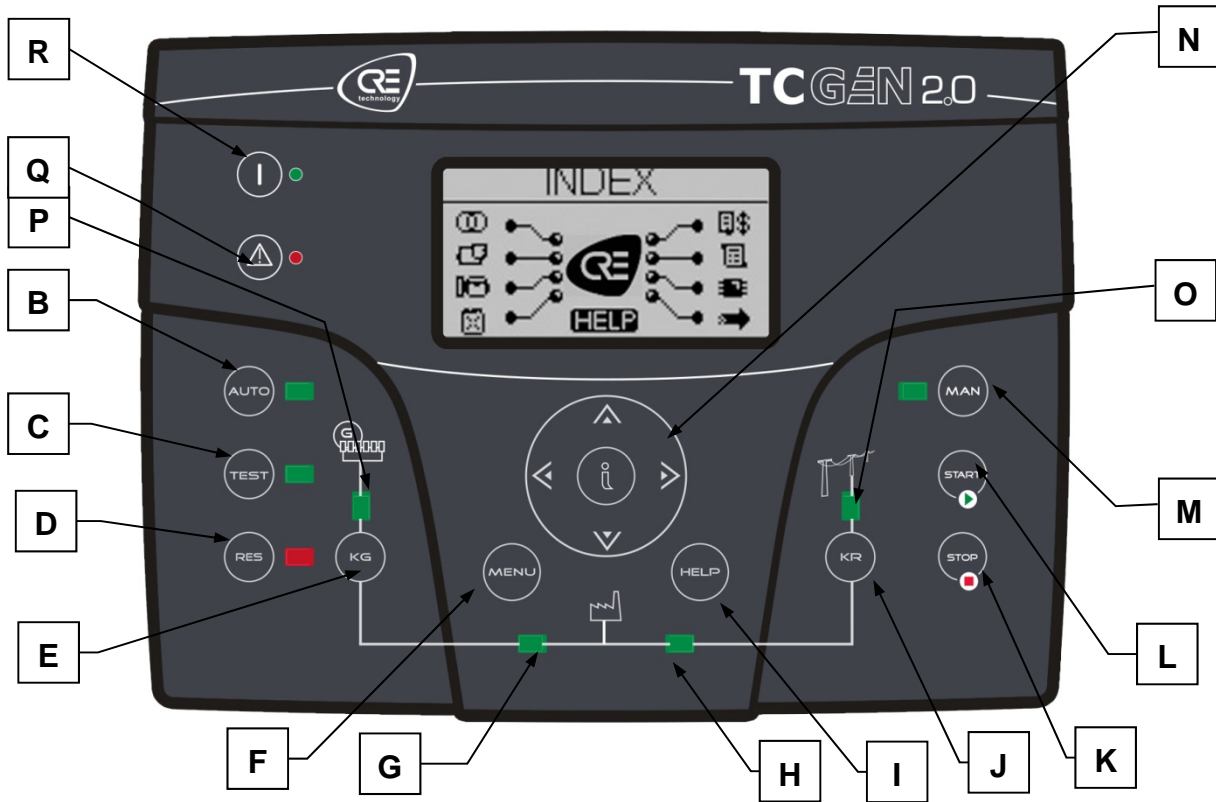

POS.	NAME	DESCRIPTION
A	Display	Backlighted display shows all functions, measures and alarms about the generator and the mains. Automatically the backlight turns off, and it turns on again when you press a button.
B	AUT	Button to select the automatic mode.
C	TEST	Button to select the test mode.
D	RESET	To activate reset/OFF mode. In this operative mode the engine is stopped without cooling and the alarms are deleted. If the cause of the alarm persists, the alarm will appear again.
E	KG	Key control for generator contactor. Active only in manual mode if the generator is running and is within the programmed voltage and frequency limits.
F	Menu	To enter the programming menu. Inside the menus, it's used as a button "back" or "esc".
G	KG state led	Led that indicates if KG is closed (led on) or open (led off).
H	KR state led	Led that indicates if KR is closed (led on) or open (led off).
I	Help	It permits you to better understand the parameters and symbols in the actual page.
J	KR	Key control for mains contactor. Active only in manual mode if the mains is within the programmed voltage and frequency limits.
K	STOP	To stop the generator immediately. Active only in manual mode.
L	START	To start the generator. Active only in manual mode.
M	MAN	Button to select the manual mode.
N	Navigation drive	Navigation drive composed by 4 arrows to scroll through the pages (left and right arrows) and increase or decrease the parameters inside the programming menus. It contains also a special button "i", to select an element on the screen or edit a parameter and confirm the new value. See paragraph 1-8.1 for more information about the navigation through the display pages, and paragraph 2-2 for more information about the navigation through the menus.
O	Mains state led	It shows if the mains is within limits (led on) or not (led off).
P	Generator state led	It shows if the generator is within limits (led on) or not (led off).
Q	General alarm led	It turns on if an alarm enabled as global alarm 1 is present.
R	Battery state led	It turns on when the board is supplied.

1.8 Display pages

1.8.1 Navigation diagram

When you turn on the board, you will see the logo page. Then you will be in the stand-by page with engine OFF (Mains 1). When you start the generator, you will go in the starting page, that will disappear when the start is completed, and redirects you to the running page. When you stop the engine, you will see a stopping page, then you will return automatically to the page you were in when you pressed the stop button. With the left and right arrows, you can move through the different sections, and with the up and down arrows you can scroll the pages of the selected section. Pressing the "i" button in any page, you go to the index page, in which it's possible to directly select the desired section. Here you can see the organization diagram of the display pages. In the index page, If the HELP symbol is present, it means that there is at least one alarm active. Pressing the HELP button, you directly go to the active alarms page.

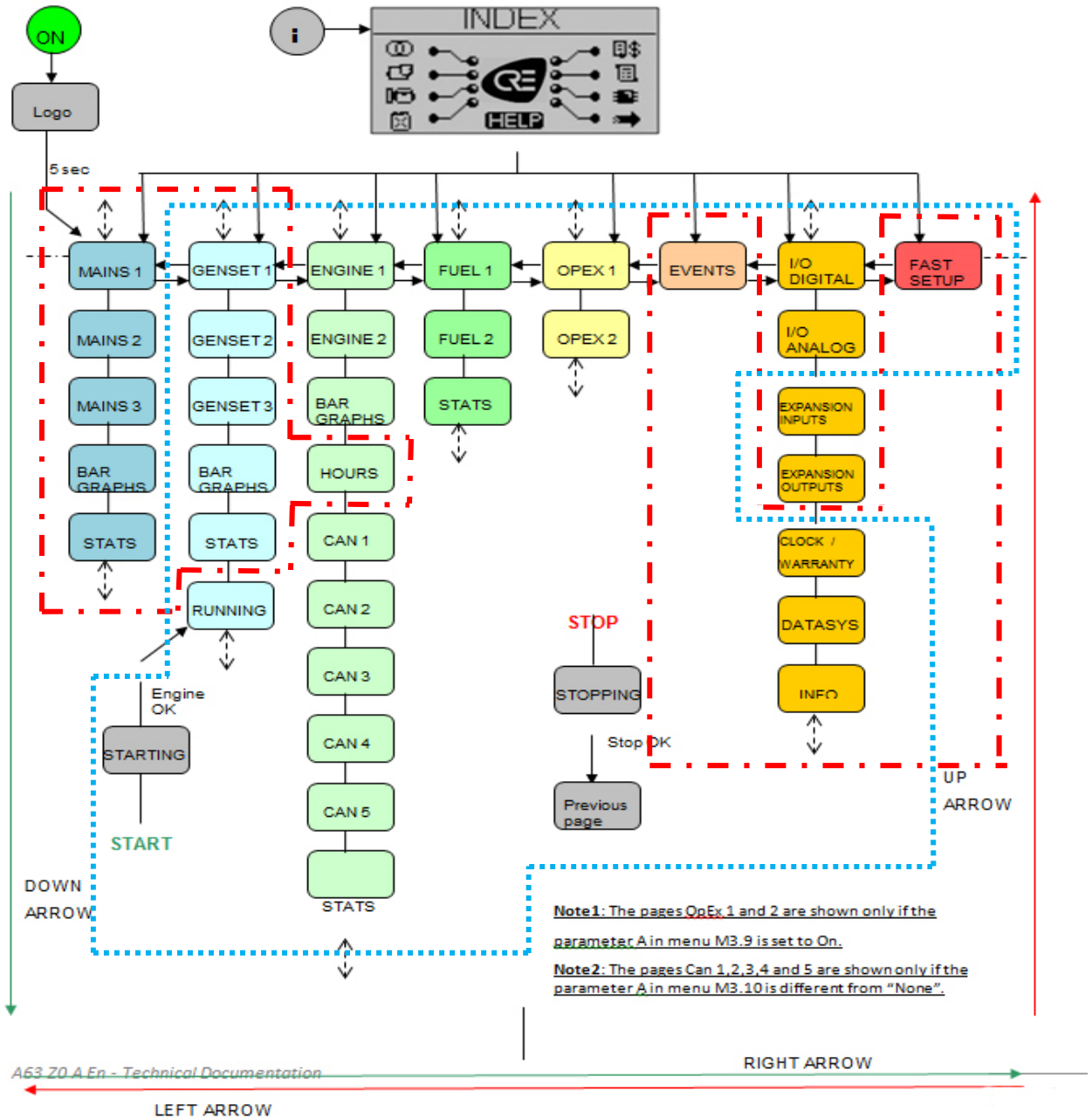

- ACGEN2.0
- - - - ICGEN2.0

1.8.2 Display pages – Navigation cursors

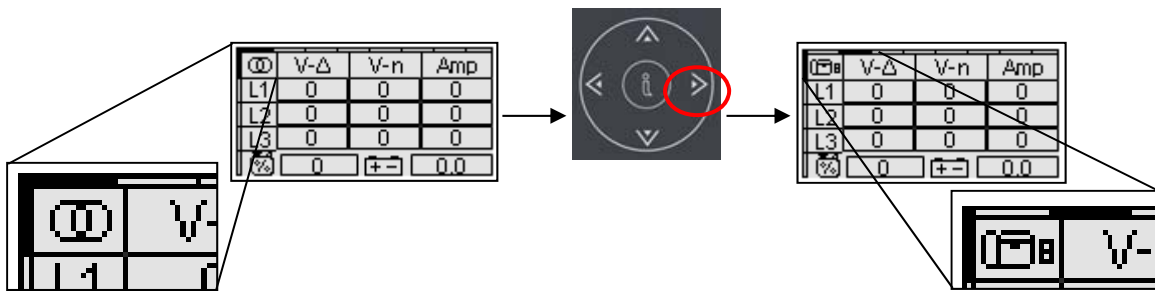

- The cursors on the upper side and left side of the display indicate the position of the page inside the navigation diagram: the left and right arrows move the page along with horizontal cursor.

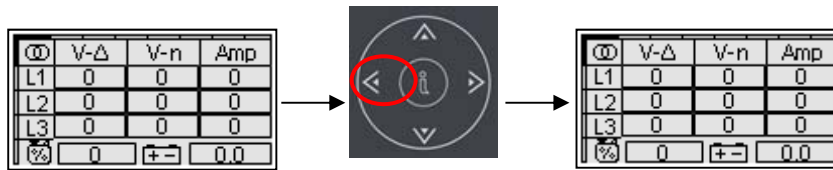

- The left arrow button allows to return back to the previous section: in this case from the generator pages to the mains pages.

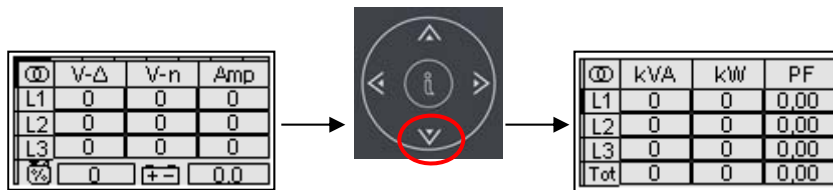

- If the vertical cursor is available on display it's possible to use up and down arrow buttons to see more pages for the section: in this case from the mains measure #1 to mains measure #2.



- With up arrow button you can return to the previous page of the section, in this case from fuel control #2 to fuel control #1. Inside the main page there is also the horizontal cursor which means that the left and right arrow buttons are available.

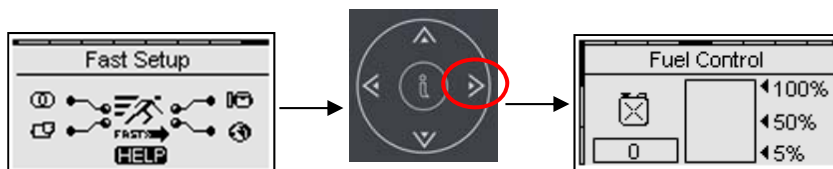

- In some of the main pages there isn't the vertical cursor. In this case up and down arrow buttons command the selection cursor in the same way as setup pages.

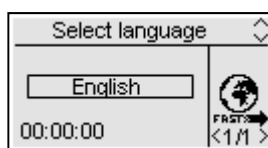

- When the controller is activated for the first time, the language selection screen will appear. If a language different from "DEFAULT" is selected, this screen will not appear anymore at the next startup.

1.8.3 Display pages - Mains

1.8.3.1 Mains 1 (stand-by with engine OFF) / Only for ICGEN2.0 & TCGEN2.0

When you turn on the board, you will see the logo page. After 5 seconds you will be in this page, that is the stand-by page with engine OFF:

Ⓞ	V-Δ	V-n	Amp
L1	0	0	0
L2	0	0	0
L3	0	0	0
Hz	0.0		

- A) Mains Vac voltages L1-L2-L3
- B) Mains line voltages L1-L2-L3
- C) Mains currents L1-L2-L3
- D) Mains frequency

1.8.3.2 Mains 2

Ⓞ	kVA	kW	PF
L1	0	0	0,00
L2	0	0	0,00
L3	0	0	0,00
Tot	0	0	0,00

- A) Mains apparent power L1-L2-L3 and total
- B) Mains active power L1-L2-L3 and total
- C) Mains power factor L1-L2-L3 and total

1.8.3.3 Mains 3

Ⓞ	kVAR	F Hz
L1	0,0	0,0
L2	0,0	
L3	0,0	
Tot	0,0	kWh

- A) Mains reactive power L1-L2-L3 and total
- B) Total kWh
- C) Generator frequency

1.8.3.4 Mains bar graphs / Only for ICGEN2.0 & TCGEN2.0

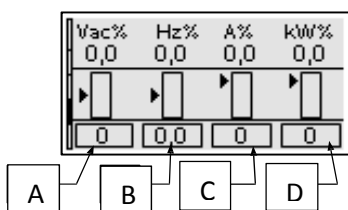

- A) Vac (% of the rated value)
- B) Hz (% of the rated value)
- C) A (% of the rated value)
- D) kW (% of the rated value)

1.8.3.5 Mains stats

Mains Stats					
Vmin	Vmax	kWmax	Amax		
0	0	0	0		
hh:mm:ss	dd/mm/yy				
0	0				

- A) Min Vac voltage L1-L2
- B) Max Vac voltage L1-L2
- C) Max kW
- D) Max current L1
- E) Hour of the selected measure
- F) Date of the selected measure

In this page, use the left and right arrows to select the measure, whose date and time of detection are shown in the squares E and F.

1.8.4 Display pages – Genset

1.8.4.1 Genset 1

	V-Δ	V-n	Amp
L1	0	0	0
L2	0	0	0
L3	0	0	0
%	0	+ -	0.0

- A) Generator Vac voltages L1-L2-L3
- B) Generator line voltages L1-L2-L3
- C) Generator currents L1-L2-L3
- D) Generator frequency
- E) Battery voltage (V_{DC})

* these value show "off" if the fuel input is not set to "analog" (see menu M8.3)

1.8.4.2 Genset 2

	kVA	kW	PF
L1	0	0	0.00
L2	0	0	0.00
L3	0	0	0.00
Tot	0	0	0.00

In this page you can monitor other electrical measures about the generator:

- A) Gen. apparent power L1-L2-L3 and total
- B) Generator active power L1-L2-L3 and total
- C) Generator power factor L1-L2-L3 and total

1.8.4.3 Genset 3

	kVAR	F _{Hz}
L1	0.0	0.0
L2	0.0	0.0
L3	0.0	kWh
Tot	0.0	0

- A) Gen. reactive power L1-L2-L3 and total
- B) Total kWh
- C) Generator frequency

1.8.4.4 Genset bar graphs

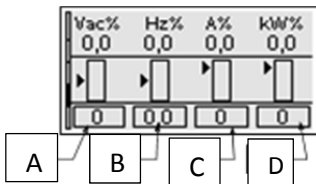

- A) Vac (% of the rated value)
- B) A (% of the rated value)
- C) Hz (% of the rated value)
- D) kW (% of the rated value)

1.8.4.5 Genset stats

Genset Stats			
V _{min} - V _{max}	Hz _{min}	A _{max}	
0	0	0.0	0
hh:mm:ss	dd/mm/yy		
0	0		

- A) Min Vac voltage L1-L2
- B) Max Vac voltage L1-L2
- C) Min frequency
- D) Max current L1
- E) Hour of the selected measure
- F) Date of the measure

1.8.4.6 Display pages – Hours / Only for ICGEN2.0

Hour Counters	
On	0
KG	0
KR	0

- A) Total work hours of the generator
- B) Total work hours with KG closed
- C) Total work hours with KR closed

1.8.4.7 Running page

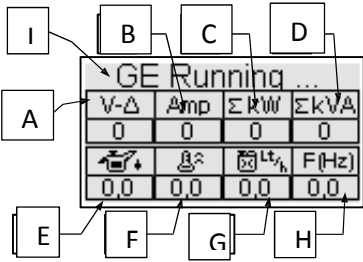

After the engine has started, you will see directly this running page

- A) Generator Vac voltage L1
- B) Generator current L1
- C) Total kW
- D) Total kVA
- E) Oil pressure*
- F) Engin temperature *
- G) Average consumption
- H) Generator frequency
- I) State of the generator

* these value show "off" if the fuel input is not set to "analog" (see menu M8.3)

1.8.5 Display pages – Engine / Only for ACGEN2.0 & TCGEN2.0

1.8.5.1 Engine 1

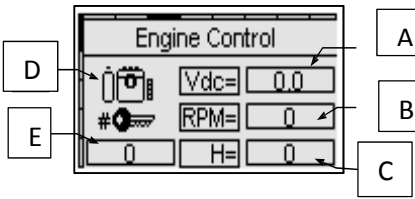

- A) Battery voltage
- B) RPM value
- C) Work hours
- D) Engine icon (black when the engine is running)
- E) Start procedure counter

1.8.5.2 Engine 2

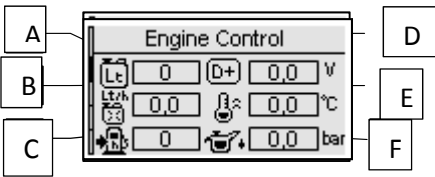

- A) Fuel level (Lt) *
- B) Instant consumption (Lt/h)
- C) Autonomy level (h) *
- D) D+ voltage (Vdc)
- E) Engine Temperature (°C) *
- F) Oil pressure (bar) *

1.8.5.3 Engine bar graphs

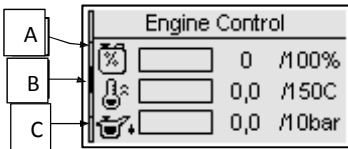

- A) Fuel level (%) bar graph *
- B) Engine temperature (°C) bar graph *
- C) Oil pressure (bar) bar graph *

1.8.5.4 Hours page

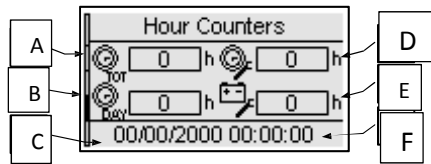

- A) Total work hours (h)
- B) Daily work hours (h)
- C) Time left to service (h)
- D) Time left to battery service (h)
- E) Date
- F) Time

1.8.5.5 Canbus 1

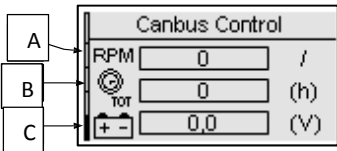

- A) RPM indicator
- B) Total work hours
- C) Battery voltage

1.8.5.6 Canbus 2

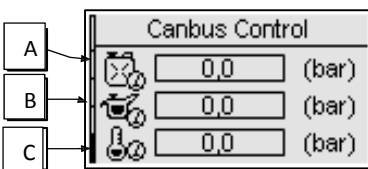

- A) Fuel pressure
- B) Oil pressure
- C) Coolant pressure

1.8.5.7 Canbus 3

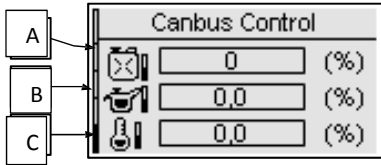

- A) Fuel level (%)
- B) Oil level (%)
- C) Coolant level (%)

1.8.5.8 Canbus 4

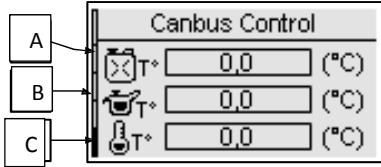

- A) Fuel temperature
- B) Oil temperature
- C) Coolant temperature

* these values show "off" if the relative input is not set to "analog" (see menu M8.3) and the analog source is ACGEN.

1.8.5.9 Canbus 5

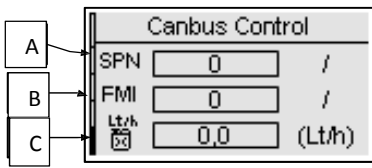

- A) SPN code (suspect parameter number)
- B) FMI code (failure mode indicator)
- C) Instant fuel consumption

1.8.5.10 Engine stats / Only for ACGEN2.0 & TCGEN2.0

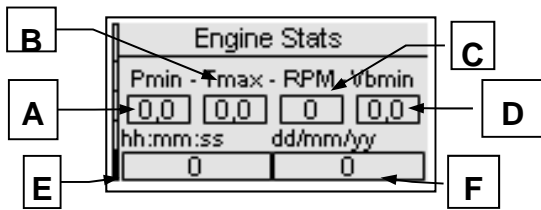

- A) Min oil pressure
- B) Max engine temperature
- C) Max RPM
- D) Min battery voltage
- E) Hour of the selected measure
- F) Date of the selected measure

1.8.6 Display pages – Fuel / Only for ACGEN2.0 & TCGEN2.0

1.8.6.1 Fuel 1

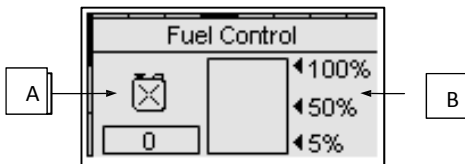

- A) Fuel level (%)
- B) Fuel level (bargraph)

1.8.6.2 Fuel 2

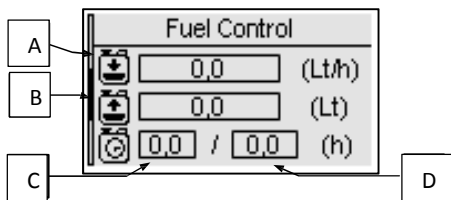

- A) Average consumption in the work cycle
- B) Litres of last refilling
- C) Actual hours in the work cycle
- D) Duration of the work cycle

1.8.6.3 Fuel stats

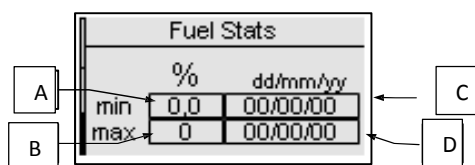

- A) Min level
- B) Max level
- C) Date of detection of the min level
- D) Date of detection of the max level

1.8.7 Display pages – OpEx / Only for ACGEN2.0 & TCGEN2.0

1.8.7.1 OpEx 1

	D	E	F
A	Opex	Lt	Total \$Total
B	LEAK	0,0	0 0
C	LtLk	0	0 0

- A) Losses for refillings not completed
- B) Losses for fuel leakages
- C) Losses for abnormal consumptions

For these 3 parameters, you can see the fuel litres that you lost for the last event (D), the total of the fuel litres lost (E), and the total money lost (F).

1.8.7.1 OpEx 2

A	Opex \$	AVG Cons. \$
B	\$	Tot. Cons. \$
C	\$Total	
		E
		D

- A) Total money lost for fuel losses
- B) Total money spent for services
- C) Total money spent (A+B)
- D) Average fuel cost of the system
- E) Total fuel cost of the system

1.8.8 Display pages – Events log

The events log page shows you the last alarms with the date and time.

Events Screen	
13/12/11 18:17:02	A
▲ Low oil pressure	
13/12/11 18:23:10	B
Startup	

Press the UP or DOWN button to select the up (A) or down (B) arrow, then press “i”. This way you can scroll the events (up to 255 events).

* these value show “off” if the fuel input is not set to “analog” (see menu M8.3)

1.8.9 Display pages – System

1.8.9.1 I/O digital

IO Monitor Digital			
In 4.4	○	Out 5.8	○
In 4.5	○	Out 5.9	○
In 4.6	○	Out 5.10	○
In 4.7	○	Out 5.11	○
In 4.8	○		

In this page you can see the state of all the 5 digital inputs (from J4.4 to J4.8) and the 6 programmables outputs (from J5.8 to J5.11, J5.4 and J5.5).

1.8.9.2 I/O analog / only for ACGEN2.0 & TCGEN2.0

IO Monitor Analog			
J6.2	0,0	J3.1	0
J6.3	0,0	J3.2	0
J6.4	0	J3.3	0
J7.1	0	J5.6	0,0

In this page you can see the state of all the 8 analog inputs.

1.8.9.3 Expansion inputs / only for TCGEN2.0

Exp. inputs			
ExIn 0	○	ExIn 4	○
ExIn 1	○	ExIn 5	○
ExIn 2	○	ExIn 6	○
ExIn 3	○	ExIn 7	○

Here you can see the state of the 8 digital inputs of the expansion board (only with expansion enabled).

1.8.9.4 Expansion outputs / **only for TCGEN2.0**

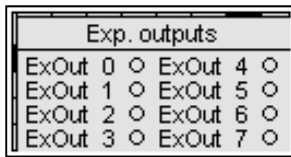

Here you can see the state of the 8 digital outputs of the expansion board (only with expansion enabled).

1.8.9.5 Clock and warranty

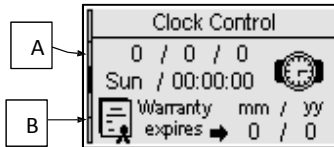

- A) Clock: date and time
- B) Warranty expiry

1.8.9.6 System data

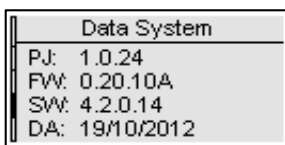

This page contains the the information about the project, the firmware and software version of the controller.

1.8.9.7 Info page



This page contains the contacts data of the manufacturer – Telephone number, fax number, web address.

1.8.10 Display pages – Start & stop / **Only for ACGEN2.0 & TCGEN2.0**

1.8.10.1 Stopping page

When the engine is stopping, you will see this page that indicates that the engine is stopping.

If the cooling procedure is active, you will see the text “cooling”, otherwise you will see the text “stopping”.

If you see the “warning” indication, it means that the stop is commanded by an alarm. Ready means the end of stop phase.

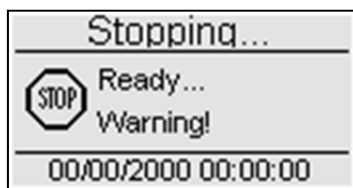

1.8.10.2 Starting page

When you start the generator you will see this page with number of start attempts and battery voltage that disappears after the starting, and redirects you to the Running page.

The upper part of this screen shows the actual phase of the engine (preheating, starting, etc...)



1.8.11 Display pages – Fast setup

In the fast setup pages you can set the most important parameters for a quick installation of the machine. You can choose between 4 menus, with the parameters listed below:



1.8.11.1 MX.1 – Fast Setup Mains / only for ICGEN2.0 & TCGEN2.0

- System type (see parameter M1.J)
- Mains rated voltage (see parameter M1.A)
- Mains rated frequency (see parameter M1.D)

1.8.11.2 MX.2 – Fast setup Generator

- System type (see parameter M2.M)
- Generator rated voltage (see parameter M2.A)
- Generator rated frequency (see parameter M2.D)
- Rated current (see parameter M2.G)
- CT ratio (see parameter M2.L)
- GE Ok delay (see parameter M2.K)

1.8.11.3 MX.3 – Fast Setup Engine / only for ACGEN2.0 & TCGEN2.0

- Tank capacity (see parameter M3.4I)
- Consumption no load (see parameter M3.4K)
- Consumption with 75% load (see parameter M3.4N)
- RPM nominal (see parameter M3.1J)
- Low DC voltage (see parameter M3.7B)
- High DC voltage (see parameter M3.7A)

1.8.11.4 MX.4 – Fast setup general

- Language (see parameter M4.1A)
- Test #1 enable (see parameter M4.3A)
- Test type (see parameter M4.3B)
- Day of the month (see parameter M4.3D)
- Day of the week (see parameter M4.3C)
- Starting hour (see parameter M4.3E)

NOTE: If a HELP symbol is present, it means that there is at least one alarm active. Pressing the HELP button, you directly go to the active alarms page.

2. PROGRAMMATION MENUS

2.9 Navigation chart – Global Setup: ICGEN2.0

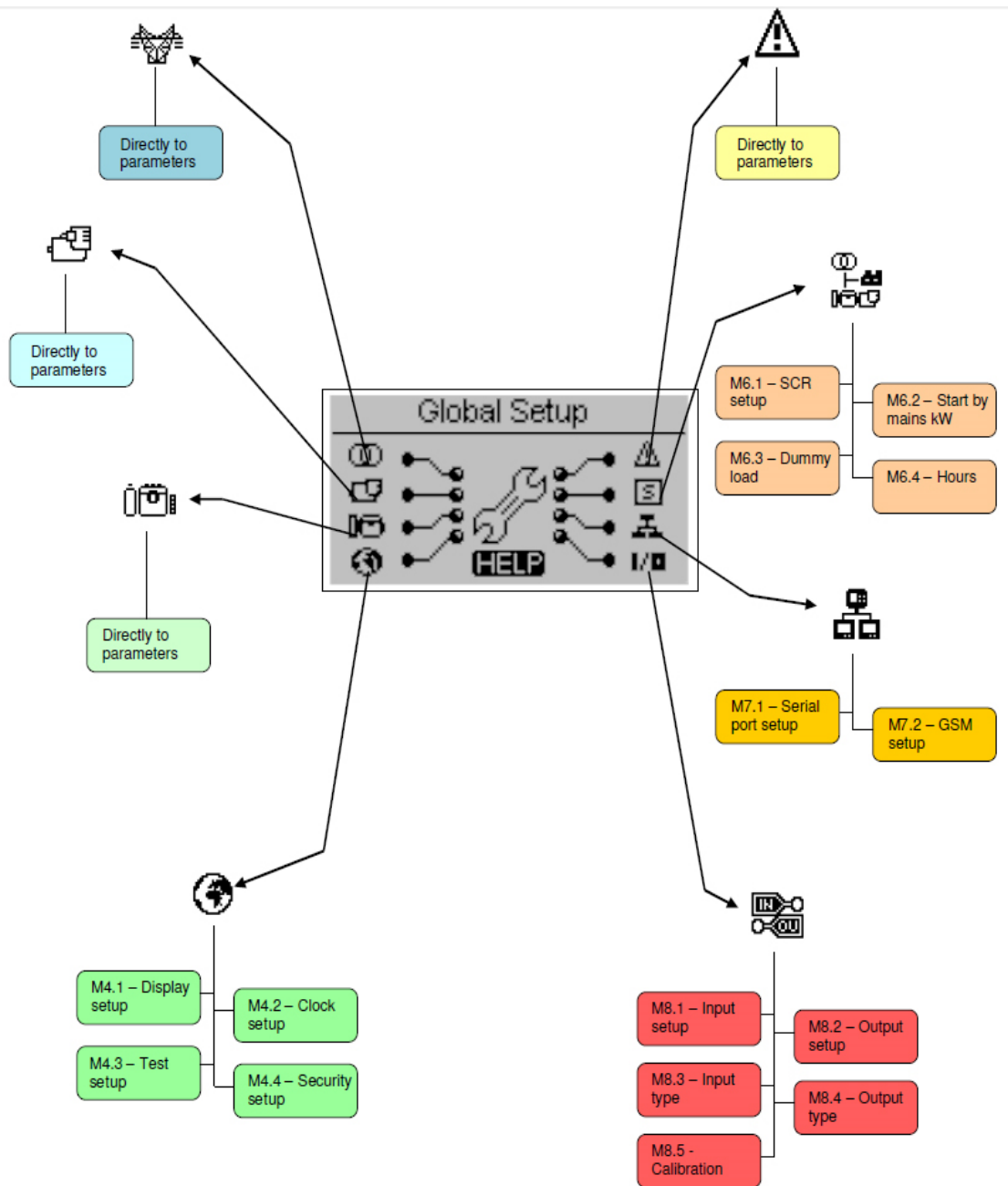

2.10 Navigation chart – Global Setup: ACGEN2.0

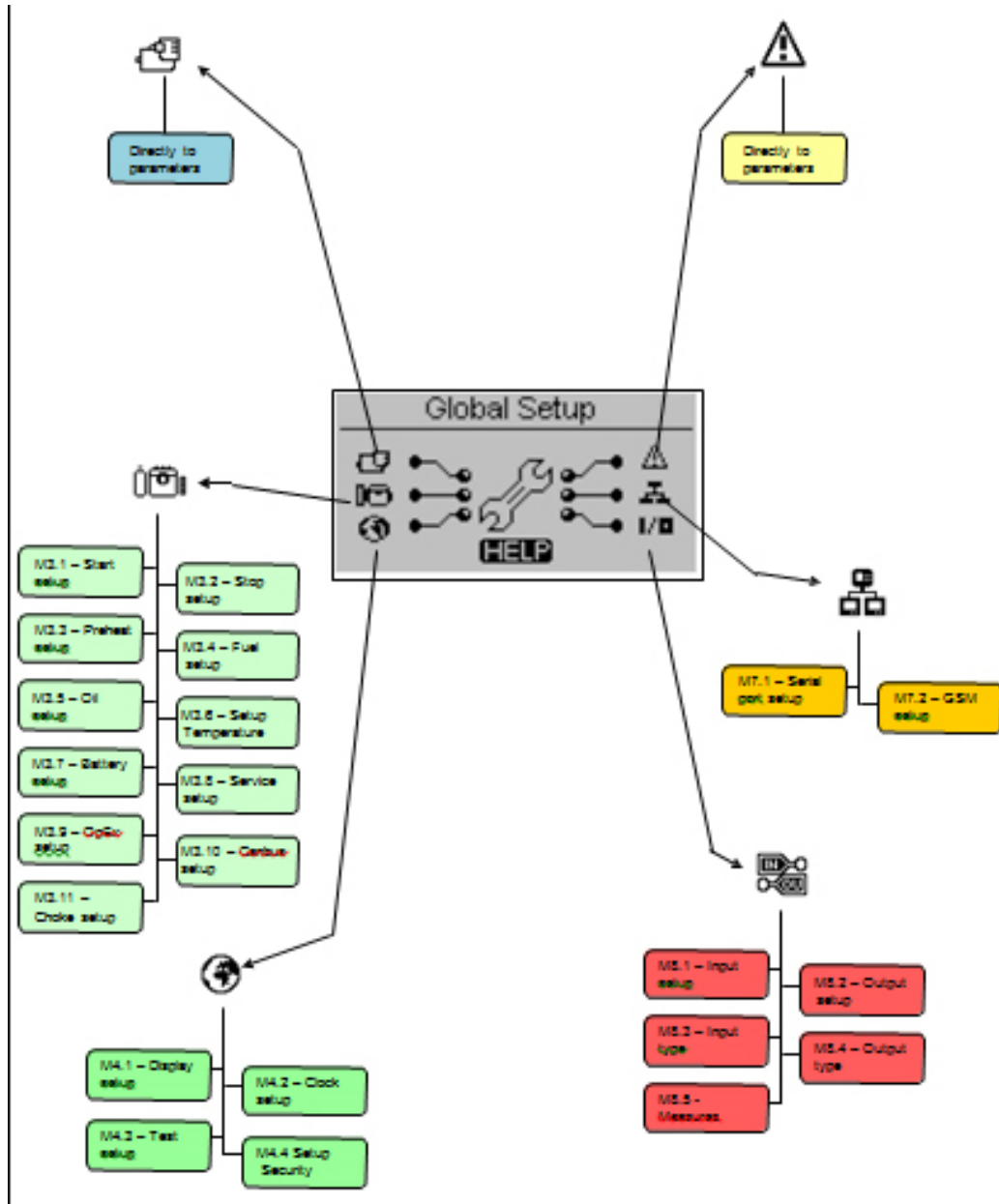

2.11 Navigation chart – Global Setup: TCGEN2.0

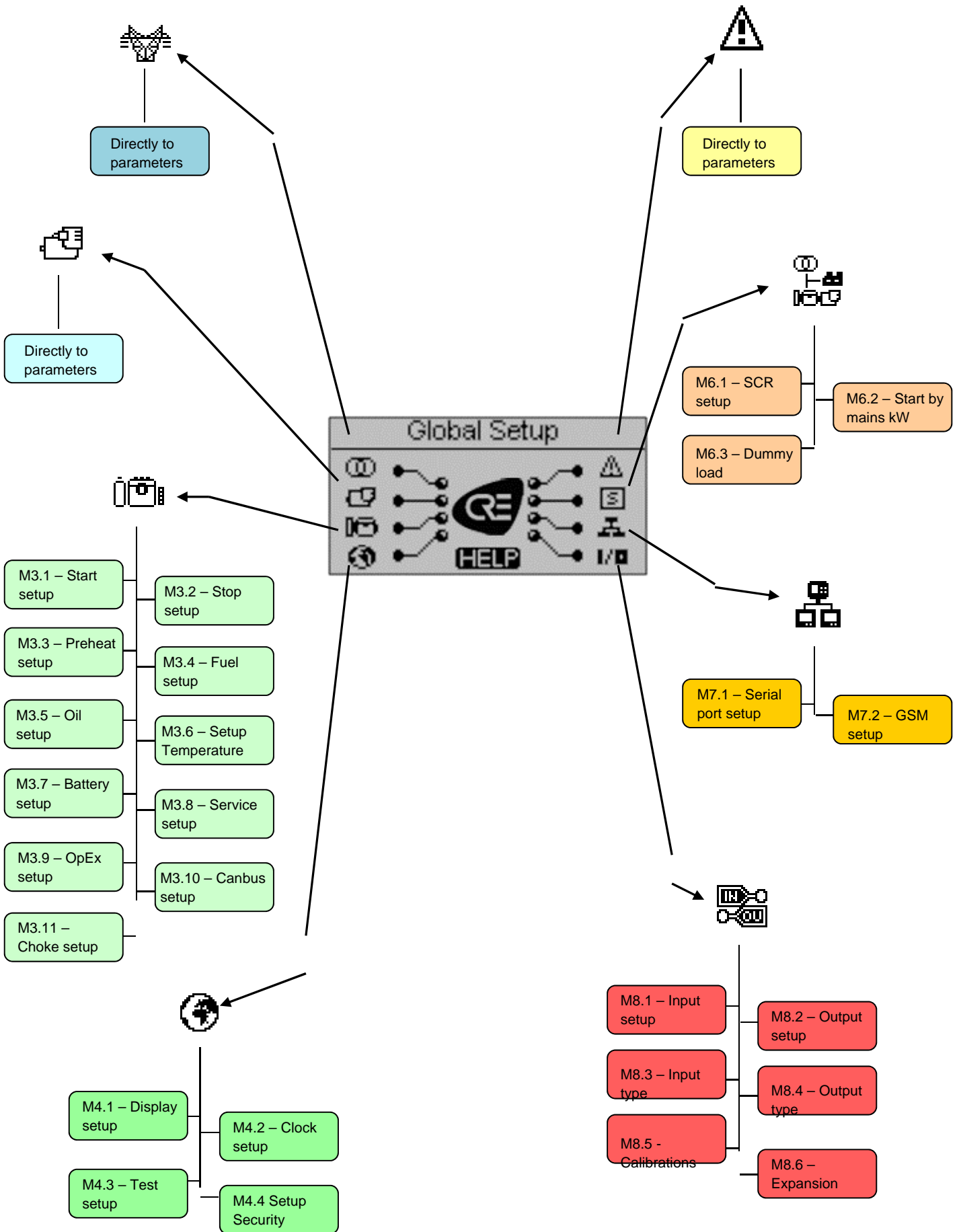

2.12 Navigation instructions

Entering global setup, pressing the MENU button, you have to insert the correct password to access to the programming menu. The password, by default, is "1". If you enter the wrong password, you will see the indication "wrong code" and you will not be able to enter inside the menu. To change the password, see the Security setup.

If the password is correct, press the DOWN arrow to select the icon (A) and confirm with "i" to enter in the programming menus.

The correct password is, by default, "1"

Note: the password that you insert will be automatically reset when you exit from the menu



From the main page you can choose 6 different menus:

- A) Mains setup / **only for ICGEN2.0 & TCGEN2.0**
- B) Alternator setup
- C) Engine setup
- D) General setup
- E) Alarms setup
- F) Special functions
- G) Connectivity
- H) I/O setup

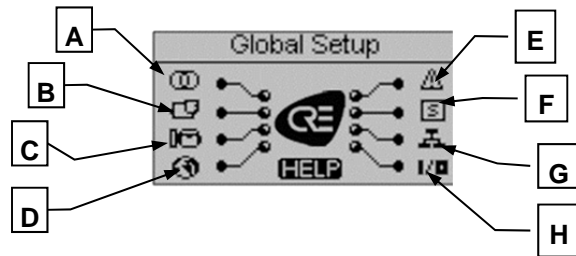

If the HELP symbol is present, it means that there is at least one alarm active. Pressing the HELP button, you directly go to the active alarms page.

With the arrows you can select the menu. Once selected the desired menu, press the "i" button to confirm and enter or press "menu" to return to the previous screen. Then you will see a screen for the choice of the submenu (except for Alternator and Alarms setup in which you will see directly the programming parameters). This screen is composed by 3 parts:

- A) The name of the submenu
- B) The icon of the submenu
- C) The page and the icon of the menu that contains the submenu

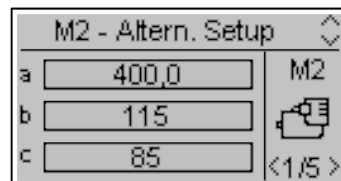
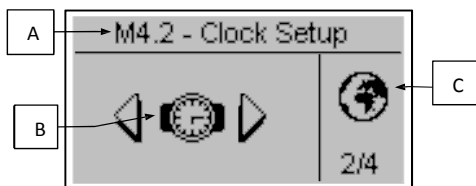

Press "i" to confirm and enter, or press the left or right arrows to see the next submenu, or press "menu" to return to the previous screen. In the submenus, the parameters are divided in different pages; choose the page with the left and right arrows, and choose the parameter with the up and down arrows. Then press "i" to confirm and modify the parameter. Then press "i" to confirm or "menu" to annull.

2.13 M1 – Mains Setup / Only for ICGEN2.0 & TCGEN2.0

Selecting the mains setup you access directly to the programming parameters about the mains, like voltage and frequency limits. All these parameters are shown in the following table:

POS.	NAME	DESCRIPTION	RANGE OF VALUES	DEFAULT SETTINGS
A	Mains rated V	Allows you to set the rated voltage.	0-600 [Vac]	400
B	Mains high V	You can set the high threshold voltage; if the voltage measured is higher than this value (% of the rated voltage), the mains is considered faulty and TCGEN2.0/ICGEN2.0 activates the remote start	100-200 [%]	115
C	Mains low V	You can set the low threshold voltage; if the voltage measured is lower than this value (% of the rated voltage), the mains is considered faulty and TCGEN2.0/ICGEN2.0 activates the remote start output (in automatic mode).	70-100 [%]	85
D	Mains rated F	Allows you to set the rated frequency.	50-60 [Hz]	50
E	Mains high F	You can set the high frequency threshold; if the frequency measured is higher than this value (% of the rated frequency), the mains is considered faulty and TCGEN2.0/ICGEN2.0 activates the	100-200 [%]	110
F	Mains low F	You can set the low frequency threshold; if the frequency measured is lower than this value (% of the rated frequency), the mains is considered faulty and TCGEN2.0/ICGEN2.0 activate the remote start output (in automatic mode).	0-100 [%]	90
G	KR delay	You can set a delay time for the closure of the mains contactor. This time starts from when the TCGEN2.0/ICGEN2.0 open the generator contactor (software interlock function).	0-100 [s]	1
H	Mains OK	It is the delay time after which, if the mains returns within the limits set (see parameters B, C, E, F), it's considered stable and the mains contactor is closed, then the remote start output is deactivated (in automatic mode).	0-9999 [s]	5
I	Faulty mains	It is the delay time after which the mains is considered faulty, compared with the limits specified in parameters B, C, E, F. This parameter is used to filter any temporary instability of the mains.	0-600 [s]	5
J	System type	You can set the type of system of the mains: three-phase, single-phase or two-phase with neutral.	Three-phase Single-phase Two-phase+n	Three-phase
K	Start delay	Delay time to start the engine in automatic mode when faulty mains conditions are true.	0-59 [s]	0
L	Stop delay	Delay time to begin engine stop procedure in automatic mode when mains within limits conditions are true. Load switching on mains side does not wait this delay which affects only the engine behaviour.	0-59 [s]	0
M	Phase sequence	Choose the sequence of the phases: R-S-T or T-S-R, or OFF	Off-RST-TSR	RST
N	Asymmetry	If the difference between the lower and the higher phase voltages is greater than this parameter, the asymmetry alarm (if enabled) is shown.	0-100 [V]	10
O	KR protection	Parameter to enable the protection on mains failure. If On, the alarms about the mains immediately open the mains contactor. If Off, the mains contactor is opened only when the generator is ready.	On-Off	On

2.14M2 – Alternator setup

Selecting the alternator setup you access directly to the programming parameters about the generator:

POS.	NAME	DESCRIPTION	RANGE OF VALUES	DEFAULT SETTINGS
A	GE rated V	Rated voltage of the generator.	0-600 [VAC]	400
B	GE high V	You can set the high threshold voltage; if the voltage measured is higher than this value (% of the rated voltage), the generator is considered faulty and TCGEN 2.0 shows the "high gen. voltage" alarm.	100-200 [%]	115
C	GE low V	You can set the low threshold voltage; if the voltage measured is lower than this value (% of the rated voltage), the generator is considered faulty and TCGEN 2.0 shows the "low gen. voltage" alarm.	0-100 [%]	85
D	GE rated F	Rated frequency of the generator.	40-70 [Hz]	50
E	GE high F	You can set the high threshold frequency; if the frequency measured is higher than this value (% of the rated frequency), the generator is considered faulty and TCGEN 2.0 shows the "high gen. frequency alarm".	100-200 [%]	110
F	GE low F	You can set the low threshold frequency; if the frequency measured is lower than this value (% of the rated frequency), the generator is considered faulty and TCGEN 2.0 shows the "low gen. frequency alarm".	0-100 [%]	90
G	Rated current	You set the nominal operating current of the generator.	0-9999 [A]	100
H	I _{max} overload	You set the maximum overload admitted on the generator. If exceeded, an alarm message is shown.	0-1000 [%]	200
I	I _{max} short circuit	You set the value that permits to consider a short circuit on the generator. If exceeded, related alarm message is shown.	0-1000 [%]	300
J	KG delay	You can set a delay time for closing the generator contactor. This time starts from when the TCGEN 2.0 opens the mains contactor (software interlock function).	0-100 [s]	1
K	GE Ok delay	Delay time over which if voltage and frequency are within limits (param. B,C,E,F), the generator is considered stable and its contactor is closed.	0-65535 [s]	5
L	CT ratio	It sets the ratio of Current Transformers to read the current value (example: CT 100/5A, you must set it at 20, because 100: 5 = 20).	0-10000	20
M	System type	You can set the type of system of the generator: three-phase, single-phase or two-phase with neutral.	Three-phase Single-phase Two-phase+n	Three-phase
N	Set kWh	Here you can set the initial value of the kWh.	0-10E+8 [h]	0
O	Rated PF %	You can set the rated power factor of the installation. It's used to calculate the max kW shown in the bar graphs on the display pages.	0-100	80
P	Fast Switch 50Hz	You can select this parameter to start the 50Hz system procedure: you will see "wait" and the following parameters will be programmed as: <ul style="list-style-type: none"> • M2.D - GE Rated F = 50Hz • M2.A - GE Rated V = 400V • M1.A - Mains Rated V = 400V • M1.D - Mains Rated F = 50Hz When the programming is done the value returns to 0. Those values are not saved inside flash memory and restarting the controller the parameters' value will be the one programmed in the standard way.	0-1	0
Q	Fast Switch 60Hz	You can select this parameter to start the 60Hz system procedure: you will see "wait" and the following parameters will be programmed as: <ul style="list-style-type: none"> • M2.D - GE Rated F = 60Hz • M2.A - GE Rated V = 230V • M1.A - Mains Rated V = 230V • M1.D - Mains Rated F = 60Hz When the programming is done the value returns to 0. Those values are not saved inside flash memory and restarting the controller the parameters' value will be the one programmed in the standard way.	0-1	0
R	Phase sequence	Choose the sequence of the phases: R-S-T or T-S-R, or OFF	Off-RST-TSR	RST
S	Asymmetry	If the difference between the lower and the higher phase voltages is greater than this parameter, the asymmetry alarm (if enabled) is shown.	0-100 [V]	10
T	GE Filter	Insert a 5-levels software filter on eventual disturbs on generator voltage and frequency. It can be set from 0 (no filtering) to 5 (high filtering), to avoid accidental opening of the generator contactor.	0-5	1
U	KG protection	Parameter to enable the protection on generator failure. If On, the alarms about the generator immediately open the generator contactor. If Off, the generator contactor is opened only when the generator is outside the limits.	On-Off	On

2.15M3 – Engine setup

The engine setup is composed by 11 submenus:

- A) **Start setup:** Submenu that contains all the parameters about the starting, like thresholds and times
- B) **Stop setup:** Submenu for the settings of the stop procedure, like modalities, times and setting of the cooling
- C) **Preheat setup:** Submenu for the settings of the preheating procedure, the modalities, times and types
- D) **Fuel setup:** Submenu with all the parameters about the fuel control and management of the wastes
- E) **Oil setup:** Submenu with all the parameters about the oil pressure, with the choice of the instrument and the thresholds
- F) **Temperature setup:** Submenu with all the parameters about the temperature, with the choice of instrument and thresholds
- G) **Battery setup:** Submenu where you can set the parameters about the battery, like the thresholds and time to battery service
- H) **Service:** Submenu that allows the setting of the parameters and hours about the services and warranty
- I) **OpEx setup:** Submenu to set the costs and parameters about the OpEx management
- J) **CANbus:** Submenu with the parameters for the CANbus communication
- K) **Choke setup:** dedicated setup for the choke function on gasoline engines

2.15.1 M3.1 - Starting setup / Only for ACGEN2.0 & TCGEN2.0



POS.	NAME	DESCRIPTION	RANGE OF VALUES	DEFAULT SETTINGS
A	Digital pressure signal	Permits to detect engine running status by the digital oil pressure sensor. It works only if connected to input J4.8.	On/Off	Off
B	D+ threshold	Permits to set the voltage of D+ of a battery charger alternator, over which the engine is considered started.	0-9999 [V]	10
C	W Threshold signal / pickup /	You set the frequency value measured on a permanent by a pickup or a "W" tachimetric sensor, over which the engine is considered started.	0-9999 [Hz]	Off
D	GE volt. ON	You set the voltage (% of the nominal voltage, see alternator menu) value measured of the power alternator, over which the engine is considered started.	0-100 [%]	20
E	GE freq. ON	You set the frequency (% of the nominal frequency, see alternator menu) value measured of the power alternator, over which the engine is considered started.	0-100 [%]	20
F	Oil pressure	Threshold on analog oil pressure input to detect engine running.	Off-10 [bar]	Off
G	Attempts number	You set the number of start attempts; when expired, the "starting failure" alarm is activated.	1-10	5
H	Attempt time	It is the maximum duration time of each starting attempt. When the engine is detected running, the crank output is de-activated.	1-30 [s]	5
I	Delay attempts	It is the time between a failed starting attempt and the next one.	1-10 [s]	5
J	RPM nominal	It is the nominal speed of the engine, used also as reference to set the limits on points K and L.	0-10000	1500
K	High RPM	You set the maximum value over which the alarm for high engine rpm appears.	0-200 [%]	120
L	Low RPM	You set the minimum value beyond which the alarm for low engine rpm appears.	0-100 [%]	80
M	RPM constant	This value multiplied with the frequency value of the engine gives you the RPM value.	0.00-100.00	30.00
N*	ON alarm delay	It is the time delay from the engine running detection to the enable of the alarms; this time allows the generator to reach the nominal operating conditions.	0-1000 [s]	8
O*	Siren time	It is the duration time of the acoustic advisor in case of alarm, if a programmable output is set for "Siren".	0-1000 [s]	20
P	Dec. delay	Time during which the output programmed for decelerator remains active at the starting of the generator, if one output is programmed for "Decelerator". At the stopping, that output is active during the whole cooling phase and the stopping phase.	Off-99 [s]	Off
Q	Choke limit	Voltage threshold that must be reached at the starting to deactivate automatically the choke output.	50-400 [V]	100

* Directly to engine setup/ Only for ICGEN2.0

2.15.2 M3.2 - Stop setup / only for ACGEN2.0 & TCGEN2.0



POS.	NAME	DESCRIPTION	RANGE OF VALUES	DEFAULT SETTINGS
A	Stop mode	You can select the logic used to stop the engine. EV+EM means that fuel valve and electrosolenoid logic are active at the same time on two different outputs.	EV EM EV+EM	EV+EM
B	Stop time	You set the maximum time of the stop phase, after which the engine must be completely stopped. It also coincides with the maximum time of supplying power to the stop electromagnet, to avoid problems due to permanent power supply.	0-99 [s]	8
C*	Cooling time	It sets the cooling time after which the engine is stopped: after the generator contactor opening, the engine continues to run for the set time, to cool down without load. <u>It works only in automatic mode.</u> In manual mode, the cooling can be made opening the generator contactor KG and, after the desired time, stopping the engine with the "stop" button.	0-255 [s]	30

* Directly to engine setup/ Only for ICGEN2.0

2.15.3 M3.3 - Preheat setup / only for ACGEN2.0 & TCGEN2.0

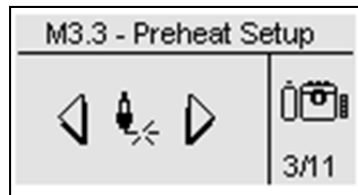

POS.	NAME	DESCRIPTION	RANGE OF VALUES	DEFAULT SETTINGS
A	Preheat time	You set the glow plugs time before starting.	0-99 [s]	5
B	Preheat with EV	If ON, during preheating is also supplied the fuel electrovalve output. If OFF, during the preheating the fuel electrovalve output is not supplied.	On-Off	Off
C	Skip preheat	You can set the value of the engine temperature above which the preheat procedure is skipped, because the engine is already considered "warm".	-999 a 999 [°C]	70
D	Preheat type	You can select the type of procedure: Before start: the glow plugs output is active only before each starting attempt. During start: the glow plugs output is active before and during each starting attempt. During attempts: the glow plugs output is active before starting, during the starting and also during the pause between attempts.	- Before start - During start - During attempts	Before start

2.15.4 M3.4 - Fuel setup / only for ACGEN2.0 & TCGEN2.0

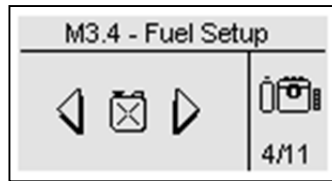

The fuel setup contains all the parameters (shown in the table) about the fuel management. See Appendix A for the table of the most common sensors.

POS.	NAME	DESCRIPTION	RANGE OF VALUES	DEFAULT SETTINGS
A	Analog tool type	You select the type of transmitter used. The curves are referred to the relevant table in appendix A.	Vdo-Veglia -Datcon-Custom	Vdo
B	Low fuel level	Value beyond which the display shows a warning message that normally does not stop the generator.	0-100 [%]	20
C	Lack of fuel	Value beyond which the display shows an alarm message that normally shuts down the generator.	0-100 [%]	10
D	Refueling enable	This parameter allows you to activate (On) or deactivate (Off) one of the programmable outputs designed to control a pump for the automatic refilling of fuel. <u>This automatic fuel refilling works only if the TCGEN2.0 is in AUT mode.</u>	On-Off	Off
E	Start refuel	It sets the fuel level below which the automatic fuel refilling starts.	0-100 [%]	30
F	Start delay	It's a time delay on the refilling starting detection to avoid false signals due to possible movements of fuel sensor in the tank.	0-59 [s]	10
G	Stop refuel	It sets the fuel level that, when reached, stops the automatic refilling.	0-100 [%]	100
H	Stop timer	You set a time limit after which the filling pump output is stopped, although the stop level was not reached. In this case an alarm (refuelling timeout) will be displayed and the refuelling function is stopped.	0-59 [min]	5
I	Tank capacity	You set the capacity of the tank. Necessary for the fuel management.	0-20000 [Lt]	100
J	Min. autonomy	If the autonomy level is under this value, the autonomy alarm appears.	0-1000 [h]	5
K	Cons. no L	You can set the hourly consumption of the engine declared by the manufacturer without load. It is necessary for fuel management.	0-10000 [Lt/h]	5
L	Cons. 25% L	You can set the hourly consumption of the engine declared by the manufacturer with 25% load. It is necessary for fuel management.	0-10000 [Lt/h]	8
M	Cons. 50% L	You can set the hourly consumption of the engine declared by the manufacturer with 50% load. It is necessary for fuel management.	0-10000 [Lt/h]	12
N	Cons. 75% L	You can set the hourly consumption of the engine declared by the manufacturer with 75% load. It is necessary for fuel management.	0-10000 [Lt/h]	15
O	Cons. 100% L	You can set the hourly consumption of the engine declared by the manufacturer with 100% load. It is necessary for fuel management.	0-10000 [Lt/h]	20
P	High cons.	When instant fuel consumption (calculated from load percentage and consumption parameters from K to O) is greater than this value, an alarm will appear.	0-65535 [Lt/h]	23
Q	Offset fuel	Adjust for the fuel level measure.	-10 – +10 [%]	0

Note: the parameters from K to O compose a 5 points curve to have an accurate evaluation of the consumptions. The controller automatically interpolates between the 5 points.

2.15-5 M3.5 – Oil pressure setup/ only for ACGEN2.0 & TCGEN2.0

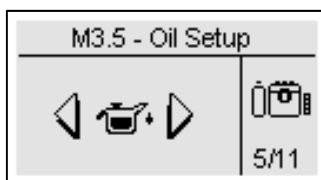

POS.	NAME	DESCRIPTION	RANGE OF VALUES	DEFAULT SETTINGS
A	Analog tool type	You select the type of transmitter used. <u>The curves are referred to the relevant table in appendix B.</u>	Vdo-Veglia - Datcon	Vdo
B	Oil pres. prealarm	Value beyond which the display shows a warning message that normally doesn't stop the generator.	1-400 [bar]	3.0
C	Low oil pres.	Value beyond which the display shows an alarm message that normally stops the generator.	1-400 [bar]	2.0

2.15-6 M3.6 – Temperature setup / only for ACGEN2.0 & TCGEN2.0

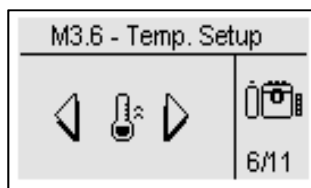

POS.	NAME	DESCRIPTION	RANGE OF VALUES	DEFAULT SETTINGS
A	Analog tool type	You select the type of transmitter used. <u>The curves are referred to the relevant table in appendix C.</u>	Vdo-Veglia - Datcon	Vdo
B	Temp. prealarm	Value over which the display shows a warning message that normally does not stop the generator.	40-999 [°C]	90
C	High temp.	Value over which the display shows an alarm message that normally stops the generator.	40-999 [°C]	100

2.15-7 M3.7 – Battery setup / only for ACGEN2.0 & TCGEN2.0

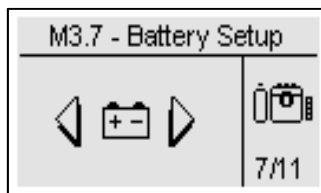

POS.	NAME	DESCRIPTION	RANGE OF VALUES	DEFAULT SETTINGS
A	High DC voltage	It sets the maximum battery voltage; if the battery value measured is higher than this value, the "High battery alarm" is shown.	0-500 [V]	16
B	Low DC voltage	It sets the minimum battery voltage; if the battery value measured is lower than this value, the "Low battery alarm" is shown.	0-500 [V]	10
C	Timer enable	It permits to enable or disable the counter about battery service.	On-Off	Off
D	Timer liquid	You set the hours at which the manufacturer recommends checking the battery fluid. After expiration, the display will show a warning message for checking.	0-65535 [h]	4320
E	Reset counter	It shows you the hours left to battery maintenance expiration. If you select and confirm by the drive this box, the counter restarts from the value set at point D.	-	-
F	Remaining h	It shows the hours remaining before the battery service.	-	-

2.15-8 M3.8 – Service setup/ only for ACGEN2.0 & TCGEN2.0

POS.	NAME	DESCRIPTION	RANGE OF VALUES	DEFAULT SETTINGS
A	Service #1 hours	You can set the hours of the first service of the generator. See suggested time by the engine and alternator manufacturers.	0-65535 [h]	100
B	Next service	Set the hours for the next services. Confirm the parameter C to increase of this value the hours left to service.	0-2000 [h]	500
C	Add service	Confirm this option to add to hours left to service the value at parameter B.	-	Ok
D	Initial work hours	It is the starting value of generator working hours. Normally you can change this value when the controller is mounted on a generator that has already worked.	0-65535 [h]	0
E	Restore hours	By drive, you can confirm it to reset the working hours to the "initial work hours" value at point D.	-	Ok
F	Edit service	This parameter permits to set the total number of working hours at which the service must be executed. For example, if the actual value of the working hours is 400, and you want for any reason that the service is made after 300 hours starting from now, you have to set this parameter to 700. <u>Note: this setting automatically overwrites the previous settings eventually made with parameters B and C.</u>	0-65535 [h]	0
G	Engine warranty time	When the work hours reach this value, you can see the alarm that the warranty has expired.	0-65535 [h]	1000
H	Reset start #	It permits to reset the number of the startings	-	Ok
I	Clear events log	If you confirm this option with "i" button, the event list is deleted.	-	Ok

2.15—9 M3.9 – OpEx management/ only for ACGEN2.0 & TCGEN2.0

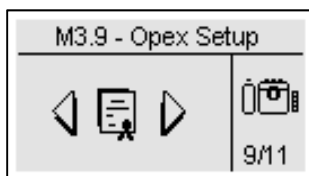

OpEx (Operating Expenditure) is the necessary cost which must be considered to use correctly the machinery. This function allows to analyze and to confront the real cost of consumed fuel with the theoretical data provided by machine manufacturer (fuel consumption without load – or 75% load).

OpEx parameters can be used to evaluate the performances of the machine over time.

To have a complete management of the fuel consumptions and wastes, follow these instructions:

- Set parameters A, I, J, K in fuel menu (see menu M3.4): Parameters J and K are necessary to evaluate the instant and average expected fuel consumptions according to the load.
- If you want to monitor the fuel leakage, set param. E and G. If the fuel decreases more than the value at parameter G with engine not running in the time at point E, the controller shows the "fuel leakage" alarm.
- If you want to monitor the fuel high leakages or stealings, set parameter E and H. If the fuel decreases more than the value at parameter H in the time at point E, the controller shows the "fuel stealing" alarm.
- To evaluate the average consumptions, set parameters D and I. After a number of work hours equal to the value set at point D have passed, the controller compares the real amount of consumed fuel with the estimated one and gives an alarm if the difference in percentage is greater than the value at parameter I.
- To evaluate if the fuel refillings are completed, you can set a percentage value at parameter F. After a refilling, if the fuel level is lower than the value at parameter F, the alarm "refilling not completed" appears.
- The costs and wastages can be calculated setting the proper values at parameters B and C.

POS.	NAME	DESCRIPTION	RANGE OF VALUES	DEFAULT SETTINGS
A	OpEx enable	Parameter to enable (On) or disable (Off) the visualization of the display pages about the OpEx function.	On-Off	Off
B	Fuel cost	Cost of the fuel in cents of \$ / liter.	0-65535 [c\$/Lt]	100
C	OpEx cost	Average monthly cost of the services.	0-65535 [\$/month]	100
D	Work cycle	This is the limit to end a work cycle and evaluate consumption data.	0-65535 [h]	8
E	Fuel check timer	Sample timer to periodically detect the fuel level. After each countdown of the timer the level is stored and compared with the previous one. If the level decreased with stopped engine, a fuel leak alarm will appear. If the level decreased too much, a fuel steal alarm will appear.	0-59 [min]	5
F	Min. refilling	Fuel level in percentage that must be reached after every refilling. If the level is lower, you will see an alarm.	0-100 [%]	20
G	Fuel Leakage	If the fuel decreases more than this value with engine not running in the "fuel check timer" time (fuel menu, parameter E), the controller shows the fuel leakage alarm.	0-1000 [Lt]	5
H	Fuel steal	If the fuel decreases more than this value in the "fuel check timer" time (fuel menu, param. E), the controller shows the "fuel stealing" alarm.	0-1000 [Lt]	30
I	Unex. Cons.	After a number of work hours equal to the value set at point D have passed, the controller compares the real amount of consumed fuel with the calculated one and gives an alarm if the difference in percentage is greater than this value. <u>Example:</u> - Work cycle = 50 hours - Unexpected fuel consumption = 10% When 50 work hours have passed, the real fuel consumed is 60 Lt while the estimated one is 50. 20% is the exceeded consumption, so an alarm will appear on the display ("Unexpected fuel consumption").	0-1000 [%]	10
J	Set leak waste	It permits to update the liters lost for leakages to this value.	0-9999 [Lt]	0
K	Set unex waste	It permits to update the liters lost for abnormal cons. to this value.	0-9999 [Lt]	0
L	Set refill waste	It permits to update the liters lost for not completed refillings to this value.	0-9999 [Lt]	0

2.15-10 M3.10 – Canbus setup / only for ACGEN2.0 & TCGEN2.0

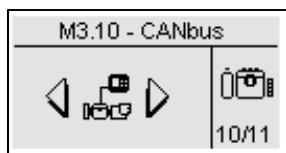

POS.	NAME	DESCRIPTION	RANGE OF VALUES	DEFAULT SETTINGS
A	Canbus Protocol	<p>Set the communication protocol of for engine canbus communication. Canbus available are:</p> <ul style="list-style-type: none"> - J1939 - SCANIA EMS - SCANIA EMS6 (Start/Stop) - SCANIA EMS8 (Start/Stop) - VOLVO EMS - VOLVO EMS2 (Start/Stop) - VOLVO EDC4 - PERKINS ECM - JOHN DEERE JDEC - DEUTZ EMR1 - IVECO NEF / CURSOR - CUMMINS CM850 - MTU ECU7 (Start/Stop) - MTU ECU8 (Start/Stop) - DEUTZ EMR2 (Start/Stop) - JCB TIER2 - ACGEN2.0 et TCGEN2.0 <p>ACGEN2.0 & TGEN2.0 is a proprietary can protocol which allows the communication between different devices of ACGEN 2.0 and ACGEN2.0 & TCGEN2.0 If set to “None”, the display pages about the CanBus are not shown.</p> <p>Protocols marked with “Start/Stop” allow to activate and shout down the engine directly from CANBUS communication.</p> <p>To start engine properly through CANBUS communication M3.1B needs to be programmed as “OFF” if no D+ signal is connected to ACGEN 2.0.</p> <p>To stop the engine properly through CANBUS communication, M3.2A parameter needs to be programmed as EM or EV+EM otherwise the stop command will not be sent to the engine ECU.</p>	None-ACGEN2.0 & TCGEN2.0	None
B	CAN baud-rate	Communication speed in bits per second for Canbus port	100 to 1000 [kbps]	250
C	ECU delay	<p>This is the time during which the ECU output (if one output is programmed for ECU) remains active after the turn-on of the controller or after the stopping of the generator. Set to Off to leave the output always active.</p> <p>The output activates also at the starting of the generator and remains active during the functioning, regardless of the programming of this parameter.</p>	Off to 59 [min]	5

2.15-11 M3.11 – Choke setup / only for ACGEN2.0 & TCGEN2.0

POS.	NAME	DESCRIPTION	RANGE OF VALUES	DEFAULT SETTINGS
A	Choke type	Choose the logic of activation of the choke output: Continuous: the choke output can be commanded during every starting attempt, in accordance with parameters B-C-D. Alternate: the choke output can be commanded only during the odd starting attempts, in accordance with parameters B-C-D.	Continuous Alternate	Continuous
B	Choke time	It is the maximum time during which the Choke output is activated during the starting.	0-255 [s]	3
C	Threshold	Voltage threshold that must be reached at the starting to deactivate automatically the choke output.	Off-500 [V]	100
D	Temp. Inhibit	When a starting procedure is commanded, if the temperature is higher than this value, the choke output is not activated.	Off-255 [°C]	Off

Notes: Remember to set one output for the choke function (see menu M8.2). This output is activated 2 seconds before the cranking output, and remains active until the value at parameter C is reached, or until the time at parameter B has passed.

If the engine is not provided with a temperature sensor, our advice is to install a thermal circuit breaker in series with the control of the choke magnet. It's also necessary to set a weekly test with minimum length of 5 minutes. For this function, see menu M4.3.

Example 1:

- a) Choke time > Attempt time
- b) Choke type = Continuous

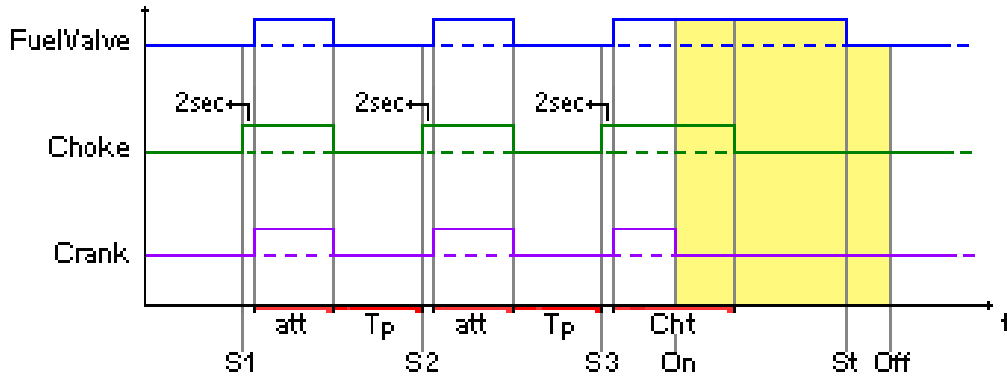

S1=Start attempt #1
S2=Start attempt #2
S3= Start attempt #3
Att = Attempt time (M3.1H)
Tp= Delay attempt (M3.1I)
Cht = Choke time (M3.11B)
On= Engine running
St= Stop command
Off= Engine stopeed

Example 2:

- c) Choke time < Attempt time
- d) Choke type = Alternate

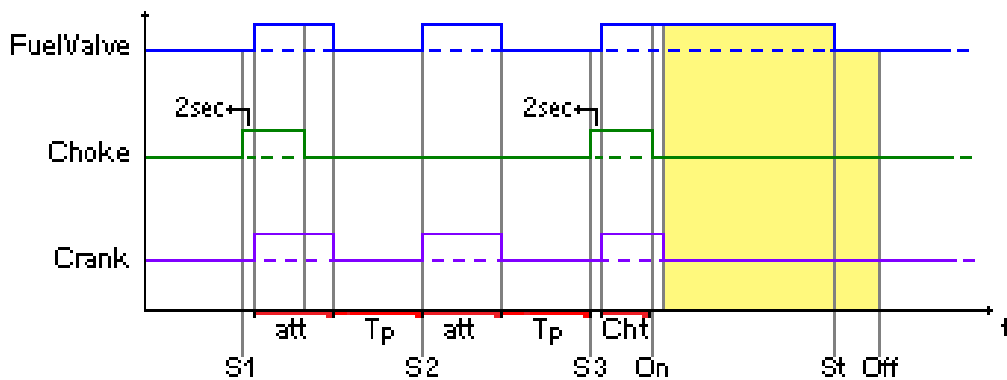

S1=Start attempt #1
S2=Start attempt #2
S3= Start attempt #3
Att = Attempt time (M3.1H)
Tp= Delay attempt (M3.1I)
Cht = Choke time (M3.11B)
On= Engine running
St= Stop command
Off= Engine stopeed

Note: in the 2 examples the temperature and the voltage threshold have not been considered. If the temperature is higher than parameter D, the choke output is not activated. If parameter C is reached during the starting, the choke output is automatically de-activated.

2.16 M4 – General setup

The general setup is composed by 4 submenus:

- A) Display setup: Submenu that contains all the parameters settings of the screen: language, contrast, etc
- B) Clock setup: Submenu with the general settings about the clock: date, time and day of the week
- C) Test setup: Submenu with the settings of the test operation mode, like the length and day of the programmable tests
- D) Security setup: Submenu to set the passwords for different levels that lock and unlock the various menus

2.16-10 M4.1 – Display setup

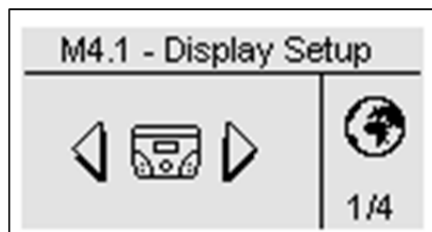

POS.	NAME	DESCRIPTION	RANGE OF VALUES	DEFAULT SETTINGS
A	Language	You select the language. On board are available the following languages: English, Italian and French. Another language can be inserted by request in the "custom" position. The controller at the turn-on will ask the settings of the language only if the "default" option is selected.	IT – EN – FR – Custom – Default	Default (EN)
B	Backlight	If no operations are done, after this time the display backlight turns off. It returns on automatically when an events occurs.	0-255 [s]	250
C	Reset stats	It permits to reset all the measures shown in the stats pages.	-	-
D	Contrast	To set the display contrast preferred for the ICGEN 2.0.	0-5	0
E	Cyclic alarms	It is the time of the cyclic indication of the active alarms. The new parameter is active at the next system startup.	0-255 [s]	3
F	Alarm Off delay	Set the delay time for the autoreset function of non-retentive stopping alarms.	Off-255 [s]	Off
G	Return to default	It is the time after which the controller automatically returns to the standby page (Mains 1) if no buttons are pressed.	Off-250 [s]	Off
H	Screen at start-up	At the power-on, if this parameter is set to ON, after 5 seconds the logo page disappears and you will see the Mains 1 page.	On-Off	On
I	Reset at start-up	If On, at the turn-on the board is automatically in reset mode. If Off, the board is instead in manual mode.	On-Off	On

2.16-11 M4.2 – Clock setup



POS.	NAME	DESCRIPTION	RANGE OF VALUES	DEFAULT SETTINGS
-	Set clock	Used to confirm the adjusted date/clock, it updates the current time with the values set in parameters C,D,E,F,G and H. To do it, you must select the area using the drive arrows and then confirm by the "i" drive button.	-	-
-	Current setting	It shows current date and clock set.	-	-
A	Year	To set the year	0-99	12
B	Month	To set the month	0-12	1
C	Day	To set the day	0-31	1
D	Day of the week	To set the day of the week from Sunday to Saturday	Sun - Sat	Sun
E	Hours	To set the current hour	0-23	12
F	Minutes	To set the current minute	0-59	0

2.16-12 M4.3 - Test setup



POS.	NAME	DESCRIPTION	RANGE OF VALUES	DEFAULT SETTINGS
A	Enable test 1	Used to enable or disable the automatic test.	On-Off	Off
B	Test type	To set the type of test.	Daily-Weekly-Monthly	Weekly
C	Day of week	If the type of test is chosen weekly, it permits to set the day of the week in which the test should be done.	Mond., Tuesd., Wed., Thur., Frid., Sat, Sund.	Thur.
D	Day of month	If the type of test is chosen monthly, it permits to set the day of the month in which the test should be done.	1-31	1
E	Start hour	You set the hour of test starting.	0-23	9
F	Start min.	You set the minute of test starting.	0-59	30
G	Enable test 2	Used to enable or disable the automatic test.	On-Off	Off
H	Test type	To set the type of test.	Daily-Weekly-Monthly	Weekly
I	Day of week	If the type of test is chosen weekly, it permits to set the day of the week in which the test should be done.	Mond., Tuesd., Wed., Thur., Frid., Sat, Sund.	Thur.
J	Day of month	If the type of test is chosen monthly, it permits to set the day of the month in which the test should be done.	1-31	1
K	Start hour	You set the hour of test starting.	0-23	9
L	Start min.	You set the minute of test starting.	0-59	30

Also, you can set some parameters that are in common for the two tests:

POS.	NAME	DESCRIPTION	RANGE OF VALUES	DEFAULT SETTINGS
M	Test length	You set the length time for the test.	0-59 [min]	5
N	Test with load	If you set it to ON, during the test, the switching between Mains and Genset should be done.	On-Off	Off
O	No remote stop	If ON, during the test the remote stop signal is not considered. If OFF, if the remote stop signal is active during the test, the engine is stopped and the test finishes automatically.	On-Off	Off
P	Test PT enable	Enable "Programmable Test" option, to finish the test at a specific end time (see programming time points Q and R), ignoring "Test length" parameter.	On-Off	Off
Q	End PT hour	Hours of end time about PT test	0-24 [h]	17
R	End PT minute	Minutes of end time about PT test	0-60 [min]	30

If the type of test chosen is "Daily", you can set the days in which the test should be done:

POS.	NAME	DESCRIPTION
-	Sunday	If the tick is present, it enables the daily test on Sunday. If the tick is removed, on this day the test is not executed.
-	Monday	If the tick is present, it enables the daily test on Monday. If the tick is removed, on this day the test is not executed.
-	Tuesday	If the tick is present, it enables the daily test on Tuesday. If the tick is removed, on this day the test is not executed.
-	Wednesday	If the tick is present, it enables the daily test on Wednesday. If the tick is removed, on this day the test is not executed.
-	Thursday	If the tick is present, it enables the daily test on Thursday. If the tick is removed, on this day the test is not executed.
-	Friday	If the tick is present, it enables the daily test on Friday. If the tick is removed, on this day the test is not executed.
-	Saturday	If the tick is present, it enables the daily test on Saturday. If the tick is removed, on this day the test is not executed.

2.16-13 M4.4 – Security setup



The security setup menu permits to enter the access codes the permit to lock/unlock the programming menus. By default, the access codes are set correctly, so you can access to all the menus. You have the possibility to protect the programming menus entering wrong codes: this way the menus correspondent to the wrong code inserted are locked. When you want to unlock the menus, simply enter in this menu and set the codes to the correct values. The 6 codes are shown in the table.

POS.	NAME	DESCRIPTION	CODE
A	Mains password	Enter the password that locks/unlocks the mains setup and the relative alarms. If you enter the code correctly to 60, the mains menu is completely unlocked. If you enter a wrong code, the menu is locked until the correct code will be inserted.	60
B	Genset password	Enter the password that locks/unlocks the alternator setup and the relative alarms. If you enter the code correctly to 50, the alternator setup is completely unlocked. If you enter a wrong code, the menu is locked.	50
C	Engine password	Enter the password that locks/unlocks the engine setup and the relative alarms. If you enter the code correctly to 40, the engine setup is completely unlocked. If you enter a wrong code, the menu is locked.	40
D	Special password	Enter the password that locks/unlocks the special functions setup. If you enter the code correctly to 30, the special functions setup is completely unlocked. If you enter a wrong code, the menu is locked.	30
E	Connectivity password	Enter the password that locks/unlocks the connectivity setup. If you enter the code correctly to 20, the connectivity setup is completely unlocked. If you enter a wrong code, the menu is locked.	20
F	I/O password	Enter the password that locks/unlocks the I/O setup. If you enter the code correctly to 10, the I/O setup is completely unlocked. If you enter a wrong code, the menu is locked.	10
G	State password	Password to lock/unlock all the alarms except the mains, generator and engine ones.	70
H	Global code	This is the password to access to the programming menus. It's possible to change it, from 000 to 999.	1

2.17 M5 - Alarms list

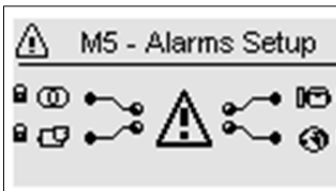

The alarms setup is composed by 4 different alarm group:

- A) Mains alarms
- B) Generator alarms
- C) Engine alarms
- D) General alarms

Select the category with the down and up arrows, then press “i” to confirm and enter.

You will see a general screen for the setup of the alarms, composed by 4 pages. In the first page, select and confirm the parameter “a” to choose the code of the alarm. In the upper part of the screen you will see the name of the correspondent alarm. Then modify the parameters from “d” to “l” as you prefer. Return then to the first page and confirm the parameter “c” to save the modifications.

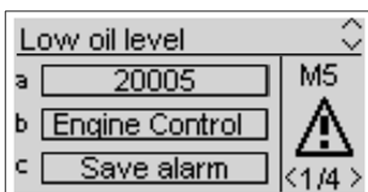

For every alarm, you can program all the following parameters:

POS.	NAME	DESCRIPTION	RANGE
A	Alarm code	Select this parameter to choose the alarm that you want to set. All the parameters in the next pages refer to the alarm selected in this parameter. In the upper part of the screen you will see also the name correspondant to the code that you are selecting.	-
B	Category of the alarm	Name of the category selected from the first screen of the alarm setup. It's not possible to modify it directly in this page.	-
C	Save alarm	Parameter that has to be confirmed with the "i" button to save all the parameters from D to L in the configuration of the alarm selected at parameter A.	-
D	Activation	It permits to choose when the alarm condition must be verified and make the alarm appear: Always (always enabled), Run (active only with engine running) or Disabled (disabled).	Always Run Disabled
E	Delay	Before the activation of the alarm, the cause must remain present for this time.	0-255 [s]
F	Retentive	Choose if the alarm must be retentive (ON: the alarm indication remains on display until you press the reset button, even if the cause has disappeared) or not (OFF: the alarm indications disappears when the cause disappears).	ON OFF
G	Action	Select the action in consequence of the activation of the alarm: Warning (only indication), Stop (the alarm stops the engine immediately) or Cooling (the alarms stops the engine with cooling).	Warning Stop Cooling
H	Siren	Set if the activation of the alarms must also activate the output programmed for Siren. It can be set to ON (the output set for "siren" is activated when the alarm is present) or OFF.	ON OFF
I	SMS	Set if the activation of the alarm must also send an SMS to the programmed numbers (see menu M7). It can be set to ON (if a modem is connected, the board sends a SMS when the alarm appears) or OFF.	ON OFF
J	Global 1	Set if the activation of the alarms must also activate the output programmed for Global alarm 1. It can be set to ON (the output is activated when the alarm is present) or OFF.	ON OFF
K	Global 2	Set if the activation of the alarms must also activate the output programmed for Global alarm 2. It can be set to ON (the output is activated when the alarm is present) or OFF.	ON OFF
L	Global 3	Set if the activation of the alarms must also activate the output programmed for Global alarm 3. It can be set to ON (the output is activated when the alarm is present) or OFF.	ON OFF

2.17.1 M5 – Alarms default parameters

N.	Category	Alarm code	Alarm name	Activation			Delay	Retentive	Action			Siren	SMS	Global 1	Global 2	Global 3
				Always	Disabled	Run			Cooling	Stop	Warning					
1	Mains	1208	Mains: low freq.		<input type="checkbox"/>		2			<input type="checkbox"/>						
2	Mains	1209	Mains: high freq.		<input type="checkbox"/>		2			<input type="checkbox"/>						
3	Mains	1210	Mains: low voltage	<input type="checkbox"/>			5			<input type="checkbox"/>						
4	Mains	1211	Mains: high voltage	<input type="checkbox"/>			5			<input type="checkbox"/>						
5	Mains	1213	Mains: V asymmetry	<input type="checkbox"/>			1			<input type="checkbox"/>	<input type="checkbox"/>			<input type="checkbox"/>		
6	Mains	20025	Faulty mains	<input type="checkbox"/>			2			<input type="checkbox"/>						
7	Mains	20031	Faulty B. charger	<input type="checkbox"/>			5			<input type="checkbox"/>	<input type="checkbox"/>			<input type="checkbox"/>		
8	Mains	20034	KR feedback	<input type="checkbox"/>			5			<input type="checkbox"/>	<input type="checkbox"/>			<input type="checkbox"/>		
9	Mains	20052	Mains: phase seq.	<input type="checkbox"/>			0			<input type="checkbox"/>	<input type="checkbox"/>			<input type="checkbox"/>		
10	Generator	1201	GE: low freq.			<input type="checkbox"/>	5	<input type="checkbox"/>		<input type="checkbox"/>	<input type="checkbox"/>			<input type="checkbox"/>		
11	Generator	1202	GE: high freq.			<input type="checkbox"/>	5	<input type="checkbox"/>		<input type="checkbox"/>	<input type="checkbox"/>			<input type="checkbox"/>		
12	Generator	1203	GE: low voltage			<input type="checkbox"/>	5	<input type="checkbox"/>		<input type="checkbox"/>	<input type="checkbox"/>			<input type="checkbox"/>		
13	Generator	1204	GE: high voltage			<input type="checkbox"/>	5	<input type="checkbox"/>		<input type="checkbox"/>	<input type="checkbox"/>			<input type="checkbox"/>		
14	Generator	1205	GE: phase seq.	<input type="checkbox"/>			0	<input type="checkbox"/>		<input type="checkbox"/>	<input type="checkbox"/>			<input type="checkbox"/>		
15	Generator	1206	GE: short circuit			<input type="checkbox"/>	2	<input type="checkbox"/>		<input type="checkbox"/>	<input type="checkbox"/>			<input type="checkbox"/>		
16	Generator	1207	GE: Imax overload			<input type="checkbox"/>	5	<input type="checkbox"/>	<input type="checkbox"/>		<input type="checkbox"/>			<input type="checkbox"/>		
17	Generator	1214	GE: V asymmetry			<input type="checkbox"/>	1	<input type="checkbox"/>		<input type="checkbox"/>	<input type="checkbox"/>			<input type="checkbox"/>		
18	Generator	20007	Ground protection	<input type="checkbox"/>			2	<input type="checkbox"/>		<input type="checkbox"/>	<input type="checkbox"/>			<input type="checkbox"/>		
19	Generator	20032	Emergency stop	<input type="checkbox"/>			0	<input type="checkbox"/>		<input type="checkbox"/>	<input type="checkbox"/>			<input type="checkbox"/>	<input type="checkbox"/>	<input type="checkbox"/>
20	Generator	20033	KG feedback	<input type="checkbox"/>			5	<input type="checkbox"/>		<input type="checkbox"/>	<input type="checkbox"/>			<input type="checkbox"/>		
21	Generator	20036	User alarm 1	<input type="checkbox"/>			3	<input type="checkbox"/>		<input type="checkbox"/>	<input type="checkbox"/>			<input type="checkbox"/>		
22	Generator	20037	User alarm 2	<input type="checkbox"/>			3	<input type="checkbox"/>		<input type="checkbox"/>	<input type="checkbox"/>			<input type="checkbox"/>		
23	Generator	20038	User alarm 3	<input type="checkbox"/>			3	<input type="checkbox"/>		<input type="checkbox"/>	<input type="checkbox"/>			<input type="checkbox"/>		
24	Generator	20040	Protection trip	<input type="checkbox"/>			3			<input type="checkbox"/>				<input type="checkbox"/>		
25	Generator	20041	GE protection	<input type="checkbox"/>			1	<input type="checkbox"/>		<input type="checkbox"/>	<input type="checkbox"/>			<input type="checkbox"/>		
26	Engine	20058 01001	ICGEN Start failure	<input type="checkbox"/>			0	<input type="checkbox"/>		<input type="checkbox"/>	<input type="checkbox"/>	<input type="checkbox"/>		<input type="checkbox"/>		
27	Engine	01003	Mechanical fault			<input type="checkbox"/>	10	<input type="checkbox"/>		<input type="checkbox"/>	<input type="checkbox"/>			<input type="checkbox"/>		
28	Engine	01101	Temp. pre alarm		<input type="checkbox"/>		2			<input type="checkbox"/>	<input type="checkbox"/>			<input type="checkbox"/>		
29	Engine	01102	High engine temp. A		<input type="checkbox"/>		2	<input type="checkbox"/>	<input type="checkbox"/>		<input type="checkbox"/>			<input type="checkbox"/>		
30	Engine	01104	Fuel pre alarm		<input type="checkbox"/>		30			<input type="checkbox"/>	<input type="checkbox"/>			<input type="checkbox"/>		
31	Engine	01105	Low fuel level A		<input type="checkbox"/>		30			<input type="checkbox"/>	<input type="checkbox"/>			<input type="checkbox"/>		
32	Engine	01107	Oil press. pre alarm		<input type="checkbox"/>		2	<input type="checkbox"/>		<input type="checkbox"/>	<input type="checkbox"/>			<input type="checkbox"/>		
33	Engine	01108	Low oil pressure A		<input type="checkbox"/>		2	<input type="checkbox"/>		<input type="checkbox"/>	<input type="checkbox"/>			<input type="checkbox"/>		
34	Engine	01110	High battery voltage		<input type="checkbox"/>		15			<input type="checkbox"/>	<input type="checkbox"/>			<input type="checkbox"/>		
35	Engine	01111	Low battery voltage		<input type="checkbox"/>		15			<input type="checkbox"/>	<input type="checkbox"/>	<input type="checkbox"/>		<input type="checkbox"/>		
36	Engine	01112	High RPM			<input type="checkbox"/>	2	<input type="checkbox"/>		<input type="checkbox"/>	<input type="checkbox"/>	<input type="checkbox"/>		<input type="checkbox"/>		
37	Engine	01113	Low RPM		<input type="checkbox"/>		5	<input type="checkbox"/>		<input type="checkbox"/>	<input type="checkbox"/>	<input type="checkbox"/>		<input type="checkbox"/>		
38	Engine	20005	Low oil level	<input type="checkbox"/>			2	<input type="checkbox"/>		<input type="checkbox"/>	<input type="checkbox"/>			<input type="checkbox"/>		
39	Engine	20006	Low coolant level	<input type="checkbox"/>			2	<input type="checkbox"/>		<input type="checkbox"/>	<input type="checkbox"/>			<input type="checkbox"/>		
40	Engine	20009	High cons. (Lt/h)			<input type="checkbox"/>	10	<input type="checkbox"/>		<input type="checkbox"/>	<input type="checkbox"/>			<input type="checkbox"/>		
41	Engine	20014	Battery service	<input type="checkbox"/>			0	<input type="checkbox"/>		<input type="checkbox"/>	<input type="checkbox"/>			<input type="checkbox"/>		
42	Engine	20015	Stop engine failure	<input type="checkbox"/>			0	<input type="checkbox"/>		<input type="checkbox"/>	<input type="checkbox"/>			<input type="checkbox"/>		
43	Engine	20016	Fuel leakage (Lt)		<input type="checkbox"/>		0	<input type="checkbox"/>		<input type="checkbox"/>	<input type="checkbox"/>			<input type="checkbox"/>		
44	Engine	20017	Fuel steal (Lt)		<input type="checkbox"/>		0	<input type="checkbox"/>		<input type="checkbox"/>	<input type="checkbox"/>			<input type="checkbox"/>		
45	Engine	20018	Unex. cons. (%)		<input type="checkbox"/>		0	<input type="checkbox"/>		<input type="checkbox"/>	<input type="checkbox"/>			<input type="checkbox"/>		
46	Engine	20019	Service	<input type="checkbox"/>			3	<input type="checkbox"/>		<input type="checkbox"/>	<input type="checkbox"/>			<input type="checkbox"/>		
47	Engine	20020	Refuelling timeout	<input type="checkbox"/>			0	<input type="checkbox"/>		<input type="checkbox"/>	<input type="checkbox"/>			<input type="checkbox"/>		
48	Engine	20023	GE warranty expired	<input type="checkbox"/>			10	<input type="checkbox"/>		<input type="checkbox"/>	<input type="checkbox"/>			<input type="checkbox"/>		
49	Engine	20024	Faulty D+		<input type="checkbox"/>		5			<input type="checkbox"/>	<input type="checkbox"/>			<input type="checkbox"/>		
50	Engine	20028	High GE temp. D			<input type="checkbox"/>	2	<input type="checkbox"/>	<input type="checkbox"/>		<input type="checkbox"/>			<input type="checkbox"/>		
51	Engine	20029	Low fuel level D	<input type="checkbox"/>			5			<input type="checkbox"/>	<input type="checkbox"/>			<input type="checkbox"/>		
52	Engine	20030	Low oil pres. D			<input type="checkbox"/>	2	<input type="checkbox"/>		<input type="checkbox"/>	<input type="checkbox"/>			<input type="checkbox"/>		
53	Engine	20035	System locked	<input type="checkbox"/>			0	<input type="checkbox"/>		<input type="checkbox"/>	<input type="checkbox"/>			<input type="checkbox"/>	<input type="checkbox"/>	<input type="checkbox"/>
54	Engine	20039	Autonomy low		<input type="checkbox"/>		10			<input type="checkbox"/>	<input type="checkbox"/>			<input type="checkbox"/>		
55	Engine	20042	Clogged filter	<input type="checkbox"/>			5	<input type="checkbox"/>		<input type="checkbox"/>	<input type="checkbox"/>			<input type="checkbox"/>		
56	Engine	20043	Tank full	<input type="checkbox"/>			5			<input type="checkbox"/>	<input type="checkbox"/>			<input type="checkbox"/>		

57	Engine	20051	No oil sensor		?	60				?	?		?		
58	General	20008	Test active	?		0				?					
59	General	20012	Stopping...	?		0				?					
60	General	20013	Start phase	?		0				?					
61	General	20021	Remote start	?		1				?					
62	General	20022	Remote stop	?		1		?			?		?		
63	General	20026	SCR	?		0				?					
64	General	20027	Failed test	?		0	?			?	?		?		
65	General	20045	GE running...	?		0				?					
66	General	20046	GE ready...	?		0				?					
67	General	20053	Full memory	?		0				?					

	Not for ACGEN2.0
	Not for ICGEN2.0

2.17-2 M5 – Alarms description

N.	Alarm code	Alarm name	Alarm description	Menu / Parameter
1	1208	Mains: low freq.	Indicates that the mains frequency is under the programmed threshold	M1-F
2	1209	Mains: high freq.	Indicates that the mains frequency is over the programmed threshold	M1-E
3	1210	Mains: low voltage	Indicates that the mains voltage is under the programmed threshold	M1-C
4	1211	Mains: high voltage	Indicates that the mains voltage is over the programmed threshold	M1-B
5	1213	Mains: V asymmetry	Indicates that the difference between the higher and the lower mains voltages is too high	M1.N
6	20025	Faulty mains	Indicates that the mains is out of limits	M1-BCEF
7	20031	Faulty B. charger	Battery charger digital input alarm	M8
8	20034	KR feedback	If KR contactor output status is not equal to input status	M8
9	20052	Mains: phase seq.	Indicates a wrong phase sequence of the mains	M1-M
10	1201	GE: low freq.	Frequency values are under the programmed limits	M2-F
11	1202	GE: high freq.	Frequency values are over the programmed limits	M2-E
12	1203	GE: low voltage	Voltage values are under the programmed limits	M2-C
13	1204	GE: high voltage	Voltage values are over the programmed limits	M2-B
14	1205	GE: phase seq.	Indicates wrong generator voltages sequence	M2-R
15	1206	GE: short circuit	Indicates an instantaneous current higher than the programmed limits for short circuit	M2-I
16	1207	GE: I _{max} overload	Indicates an instantaneous current higher than the programmed limits for overload	M2-H
17	1214	GE: V asymmetry	Indicates that the difference between the higher and the lower genset voltages is too high	M2-S
18	20007	Ground protection	Ground protection digital input alarm	M8
19	20032	Emergency stop	It indicates that the input programmed as "emergency button" is active	M8
20	20033	KG feedback	If KG contactor output status is not equal to input status	M8
21	20036	User alarm 1	Alarm that is present when the digital input programmed as user alarm 1 is active	M8
22	20037	User alarm 2	Alarm that is present when the digital input programmed as user alarm 2 is active	M8
23	20038	User alarm 3	Alarm that is present when the digital input programmed as user alarm 3 is active	M8
24	20040	Protection trip	"Protection trip" digital input alarm	M8
25	20041	GE protection	"External GE protection" digital input alarm	M8
26	20055 01001	Start failure/ICGEN2.0 Start failure	Indicates that the engine is not detected running after the start attempts in automatic mode	M3.1
27	01003	Mechanical fault	Indicates that all engine running detection signals are lost without a command from the controller to stop the engine	M3.1
28	01101	Temp. pre alarm	Indicates analog engine temperature higher than programmed pre-alarm threshold	M3.6-B
29	01102	High engine temp. A	Indicates analog engine temperature higher than programmed alarm threshold	M3.6-C
30	01104	Fuel pre alarm	Indicates analog fuel level lower than programmed pre-alarm threshold	M3.4-B
31	01105	Low fuel level A	Indicates analog fuel level lower than programmed alarm threshold	M3.4-C
32	01107	Oil press. pre alarm	Indicates analog oil pressure lower than programmed pre alarm threshold	M3.5-B
33	01108	Low oil pressure A	Indicates analog oil pressure lower than programmed alarm threshold	M3.5-C
34	01110	High battery voltage	Indicates a battery voltage higher than programmed value	M3.7-A
35	01111	Low battery voltage	Indicates a battery voltage lower than programmed value	M3.7-B
36	01112	High RPM	Indicates an engine speed value higher than programmed value	M3.1-K
37	01113	Low RPM	Indicates an engine speed value lower than programmed value	M3.1-L
38	20005	Low oil level	Oil level digital input alarm	M8
39	20006	Low coolant level	Coolant level digital input alarm	M8
40	20009	High cons. (Lt/h)	This alarm indicates a fuel consumption greater than programmed value inside Fuel Setup	M3.4
41	20014	Battery service	Indicates that the battery service timer has expired and the engine battery must be verified	M3.7
42	20015	Stop engine failure	Indicates that the engine is still detected running after a stop phase	M3.2

43	20016	Fuel leakage (Lt)	Indicates a fuel level decrease with engine stopped	M3.9
44	20017	Fuel steal (Lt)	Indicates a detection of large fuel level decrease during both running and stopped engine	M3.9
45	20018	Unex. cons. (%)	At the end of each work cycle the consumed fuel is compared with calculated fuel consumption, if these value differs too much this alarm will be displayed	M3.9
46	20019	Service	Indicates that service timer has expired	M3.8
47	20020	Refuelling timeout	Indicates that the maximum time with refuelling output active has been reached	M3.4
48	20023	GE warranty expired	Indicates that warranty timer has expired	M3.8
49	20024	Faulty D+	Indicates an alternator D+ voltage under 4V _{dc} with engine running	-
50	20028	High GE temp. D	High temperature digital input alarm	M8
51	20029	Low fuel level D	Low fuel level digital input alarm	M8
52	20030	Low oil pres. D	Low oil pressure digital input alarm	M8
53	20035	System locked	Internal system alarm which stops the generator for safety measures	-
54	20039	Autonomy low	If autonomy hours calculated with load percentage, fuel consumption and fuel level are lower than the programmed value, the alarm will be shown	M3.4
55	20042	Clogged filter	"Clogged air filter" digital input alarm	M8
56	20043	Tank full	"Fuel tank full" digital input alarm	M8
57	20051	No oil sensor	It indicates that the oil pressure digital sensor is open with engine not running	-
58	20008	Test active	Signalization active during test procedure	M4.3
59	20012	Stopping...	Indicates an active stop procedure	-
60	20013	Start phase	Indicates an active start procedure	-
61	20021	Remote start	Indicates remote start function from digital input	M8
62	20022	Remote stop	Indicates remote stop function from digital input	M8
63	20026	SCR	Indicates that the remote start input (if programmed as SCR) is active	M6.1
64	20027	Failed test	Indicates an unsuccessful test: in manual if mode the engine has not started after the attempts number; in automatic mode if a stopping alarm occurs during test procedure	M4.3
65	20045	GE running...	Indication that is active when the generator is detected running	-
66	20046	GE ready...	Indication that the generator is not running and without blocking alarms	-
67	20053	Full memory	Enabled only if datalogger is enabled and its relative memory space is full	M7.1-F

Not for ACGEN2.0
Not for ICGEN2.0

2.17-3 M6 - Special functions

The TCGEN2.0 permits three special functions **active only in automatic mode**: SCR, Start by mains kW and Dummy load. The relative parameters can be set in this menu. Here you can also set the type of use of all the programmable inputs and outputs. The submenus are the following:

- A) SCR (only automatic mode)
- B)..... Start by mains kW (only automatic mode)
- C)..... Dummy Load (only automatic mode)
- D) Hour counters / **Only for ICGEN2.0**

2.17-4 M6.1 – SCR/ only for ICGEN2.0 & TCGEN2.0

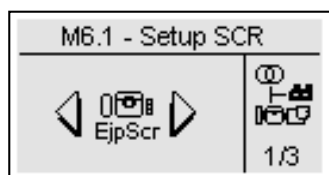

It permits to start the generator by a remote signal on one of the programmable inputs, that you have to set to remote start (see par. 2-10). When that input is closed to negative, after a START BY SCR DELAY time, the generator starts.

Then:

- a) If SCR 2 ENABLE is set to OFF: when the KG DELAY time has elapsed, TCGEN2.0 switches the changeover switch on generator side, even if the mains is detected.
- b) If SCR 2 ENABLE is set to ON: after the generator has started, you have to wait that the second programmable input (that you have to set to remote stop, see par. 2-10) is closed to negative, then after the KG DELAY time, TCGEN2.0 switches the changeover switch on generator side, even if the mains is detected.

"No KR with SCR" option permits to inhibit, in case of generator alarm, the changeover switch on mains side.

POS.	NAME	DESCRIPTION	RANGE OF VALUES	DEFAULT SETTINGS
A	SCR enable	If ON the function is enabled, if OFF the function is disabled.	On/Off	Off
B	Start delay	It is the delay time that elapses when you close to negative the terminal programmed as remote start before the generator starting.	0-999 [s]	5
C	KG delay	It is the delay time that elapses after the starting of the generator (if parameter D is OFF) or after the closure to negative of the input programmed as remote stop (if parameter D is ON) before the switching of the changeover switch.	0-999 [s]	5
D	SCR 2 input	If ON, it enables the changeover switch control by the remote stop terminal closed to negative; when closed and after the delay time at point C, the load switches to generator. If OFF, the remote stop input is disabled and is not used to control the changeover switch: changeover switch is automatically closed on generator side when the engine is started by the remote start input and after the delay time at point C.	On/Off	On
E	No KR with SCR	If ON, when SCR mode is active (remote start input active), the mains contactor opens and it's not possible to close it also if the generator is stopped by an alarm.	On/Off	Off
F	Off delay	It is the delay time during which the EJPT signal must be disabled to permit the stopping of the generator and the switching on the mains.	0-999]	5

2.17-5 M6.2 – Start by mains kW / only for ICGEN2.0 & TCGEN2.0

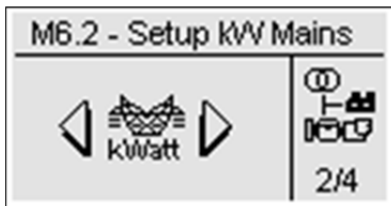

Function that allows the generator's automatic start and stop, according to the maximum and minimum thresholds programmable on mains consumption. If the load consumption from the mains supplies exceeds the START THRESHOLD for a period of time longer than the TIME FOR START, ICGEN 2.0 starts the generator and switch the load for the generator. When the value of load's consumption is less than the STOP THRESHOLD at least for the TIME FOR STOP time, the load is commutated to the mains (if available) and the generator is stopped. If the mains is missing, the load remains on generator until the mains voltage is detected.

POS.	NAME	DESCRIPTION	RANGE OF VALUES	DEFAULT SETTINGS
A	kW mains Enable	If ON the function is enabled, if OFF it is disabled.	On / Off	Off
B	Start power	Load supplied by the mains: if the power consumption exceeds this value (at least for the "time for start" at point C), the generator starts and the power switching moves on the generator.	0-5000 [kW]	100
C	Time for start	It is the delay time for which the load consumption must remain over the threshold value on the mains (point B); after this time the generator starts.	0-59 [s]	30
D	Stop power	Load is supplied by the generator: if the power consumption returns to be less than this threshold value set (at least for the "time for stop" at point E), the load switches to the Mains and the generator is stopped.	0-5000 [kW]	80
E	Time for stop	It's the delay time for which the load consumption must remain below the threshold value; after this time the load returns to the Mains and the generator is stopped.	0-59 [s]	30

2.17-6 M6.3 – Dummy load / only for ICGEN2.0 & TCGEN2.0



Function that allows to activate one of the programmable outputs, according to the maximum and minimum thresholds programmable on load consumption. If the load consumption is lower than the DUMMY ON for a period of time longer than the ON DELAY, the board activates all the outputs that you programmed for Dummy load function (see par. 2-10 for the programming of the outputs). When the value of load consumption is higher than the DUMMY OFF at least for the OFF DELAY time, the outputs are de-activated. To activate this function, you have to set at least one of the programmable outputs for “dummy load” (see par. 2-10), then you have to set the following parameters.

POS.	NAME	DESCRIPTION	RANGE OF VALUES	DEFAULT SETTINGS
A	Dummy enable	If ON the function is enabled, if OFF the function is disabled.	On / Off	Off
B	Dummy On	Load supplied by generator: if the power consumption is lower than this value (at least for the “On delay” at point C), the outputs programmed as “dummy load” are activated.	0-5000 [kW]	50
C	On delay	It is the delay time for which the load consumption must remain under the threshold value on the generator (point B); after this time the outputs are activated.	0-59 [s]	30
D	Dummy Off	Load is supplied by the generator: if the power consumption exceeds the threshold value set (at least for the “Off delay” at point E), the outputs programmed as “dummy load” are deactivated.	0-5000 [kW]	100
E	Off delay	It is the delay time for which the load consumption must remain over the threshold value on the generator (point D); after this time the outputs are deactivated.	0-59 [s]	30

2.17-7 M6-4 Hours / Only for ICGEN2.0



POS.	NAME	DESCRIPTION	RANGE OF VALUES	DEFAULT SETTINGS
A	Run hours	Here you can set a value of the work hours, then confirm the parameter D to set the actual work hours to this value.	0-999999 [h]	0
B	KG hours	Here you can set a value of the work hours with KG closed, then confirm the parameter D to set the actual work hours with KG closed to this value.	0-999999 [h]	0
C	KR hours	Here you can set a value of the hours with KR closed, then confirm the parameter D to set the actual hours with KR closed to this value.	0-999999 [h]	0
D	Counter reset	Confirm this parameter to set the values at parameters A, B and C. It becomes 1 for a small time after you confirmed it.	0-1	0
E	Clear events log	If you confirm this option with "i" button, the event list is deleted.	-	Ok

2.18 M8 – I/O setup

The IO setup is composed by 5 submenus:

- A) Input setup: Submenu that contains all the parameters about the input functions available: select which digital input is connected with each function.
- B) Output setup: Submenu that contains all the parameters about the output functions available: select which function must performed by each digital output.
- C) Input type: Submenu for the settings of input type: you can select between disabled, normally open, normally closed or analog if the input allows it.
- D) Output type: Submenu for the settings of output type: you can select between disabled, normally open or normally closed
- E) Measures: Submenu to adjust voltage and current measures with a programmable offset.
- F) Expansion: Enable expansion board and set options.

2.18-1 M8.1 - Input setup

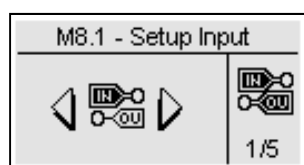

The I/O menu permits to select the type of use of the 5+3 programmable digital inputs.

The inputs I4.4, I4.5, I4.6, I4.7, I4.8, I6.2 (digital / analog oil pressure), I6.3 (digital / analog water temperature), I6.4 (digital / analog fuel level) can be programmed as:

POS.	NAME	RANGE OF VALUES	DEFAULT SETTINGS
A	Low oil pressure	None - I4.4 - I4.5 - I4.6 - I4.7 - I4.8 - I6.2 - I6.3 - I6.4 - EXIN_0 - EXIN_1 - EXIN_2 - EXIN_3 - EXIN_4 - EXIN_5 - EXIN_6 - EXIN_7	I4.8
B	High engine temperature	Same as parameter A	I4.5
C	Low fuel level	Same as parameter A	None
D	Emergency stop	None – I4.4 – I4.5 – I4.6 – I4.7 – I4.8 – I6.2 – I6.3 – I6.4 – I5.3 (output relays common pole)	I5.3
E	Remote start *	Same as parameter A	I4.6
F	Remote stop **	Same as parameter A	I4.7
G	Low coolant level	Same as parameter A	I4.4
H	Battery charger alarm	Same as parameter A	None
I	Low oil level	Same as parameter A	None
J	Ground protection	Same as parameter A	None
K	Feedback KG	Same as parameter A	None
L	Feedback KR	Same as parameter A	None
M	User alarm 1	Same as parameter A	None
N	User alarm 2	Same as parameter A	None
O	User alarm 3	Same as parameter A	None
P	Input 50-60 ***	Same as parameter A	None
Q	Clogged air filter	Same as parameter A	None
R	Fuel tank full	Same as parameter A	None
S	Load contactor open	Same as parameter A	None
T	External GE protection	Same as parameter A	None
U	External mains control ****	Same as parameter A / Not for ACGEN2.0	None

	Not for ACGEN2.0
	Not for ICGEN2.0

* Remote start: in automatic mode, when closed to negative, it commands the starting of the generator. When open the generator is stopped

** Remote stop: the input, when closed to negative, commands the stop of the generator with priority on remote start input.

*** Input 50-60: if the selected input is active the setup programming is automatically converted for 60Hz system (F rated = 60Hz, Rpm rated = 1800 rpm, V rated = 230V). If selected input is inactive the setup programming is automatically converted for 50Hz systems (F rated = 50Hz, Rpm rated = 1500 rpm, V rated = 400V).

**** External mains control: if the selected input is active, the mains is detected within limits also if measurements of voltage and frequency are outside programmed values.

Important: if a digital input function is associated to an analog / digital input (for example: I6.4 fuel level) the input type must be programmed as Digital inside Input type menu. In this case the function associated with analog measure will be unavailable (remember that Opex function needs analog fuel measure to work). Same for analog oil pressure or analog engine temperature. If you want both digital and analog sensors, set the inputs 6.2, 6.3 and 6.4 for the analog sensors, and set other programmable inputs for the digital sensors.

2.18-2 M8.2 – Output setup

Start: the output is used to command the start.	
EV: the output is used to command the stop with EV.	
EM: the output is used to command the stop with EM.	
Preheat: the output is used to command the preheating function, with modality that you can set in the preheat setup.	
Siren: the output is used to command a siren that sounds when an alarm with siren enabled appears.	
Global alarm 1: the output is used to command an indication when an alarm set as general alarm 1 appears. The output remains active until you reset or the alarm disappears.	
Engine ON: the output is activated when the generator is running.	
Test active: the output is used to signal that the test is active.	
Refueling pump: the output is used to command the start and stop of a refueling pump. The parameters about the refilling functions can be set in the fuel menu.	
Dummy load: the output is used for the dummy load function. To have more information about this function, see menu 2-8.3.	
Reset mode: indicates that the controller is in reset mode	
Auto mode: indicates that the controller is in automatic mode	
Man mode: indicates that the controller is in manual mode	
Global alarm 2: the output is used to command an indication when an alarm set as general alarm 2 appears. The output remains active until you reset or the alarm disappears.	
Global alarm 3: the output is used to command an indication when an alarm set as general alarm 3 appears. The output remains active until you reset or the alarm disappears.	
KG ON: indicates that the generator contactor is closed	
KR ON: indicates that the mains contactor is closed	
Global alarm pressure: indicates that one alarm about the oil pressure is active	
Global alarm temperatures: indicates that one alarm about the engine temperature is active	
Global alarm level: indicates that one alarm about the fuel level is active	
Choke: output that is activated for the starting of Gasoline engines, with time and limits settable in the choke setup	
ECU: output that is active during the functioning of the generator, and for a programmable time after the stopping of the generator and the turn-on of the controller. See paragraph 2-5.10 for more information	
Decelerator: the output is activated for a programmable time (M3.1 – parameter P) after the detection of engine running. This output is also active during all the cooling phase and the stop phase.	
Accelerator: the output is activated after a programmable time at the starting (M3.1 – parameter P), and it is de-activated at the beginning of the cooling/stop phase.	
Faulty start: indicates that the generator is not detected running after the starting procedure	

	Not for ACGEN2.0
	Not for ICGEN2.0

POS.	NAME	RANGE OF VALUES	DEFAULT SETTINGS
A	O5.8	Start - EV - EM - Glow plugs - Siren - Global alarm 1 – Engine running – Test active – Refuelling pump – Dummy load – Reset mode – Auto mode – Man mode – Global alarm 2 – Global alarm 3 – KG ON – KR ON – Global alarm pressure – Global alarm temperature – Global alarm level – Choke – ECU – Decelerator –Accelerator	Global alarm 1
B	O5.9	Same as parameter A	Glow plugs
C	O5.10	Same as parameter A	Siren
D	O5.11	Same as parameter A	Electro solenoid (EM)
E	O5.5 Start	Same as parameter A	Start
F	O5.4 EV	Same as parameter A	EV

2.18-3 M8.3 - Input type

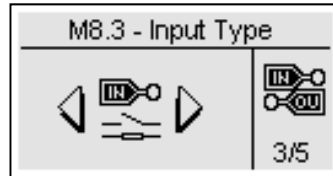

The input type setup permits to select the type of programmable inputs.

The inputs I4.4, I4.5, I4.6, I4.7, I4.8 can be programmed as:

- Disabled: the input is not active
- Digital NO: the input is digital type normally open
- Digital NC: the input is digital type normally closed

The inputs I6.2, I6.3, I6.4 can be programmed as:

- Disabled: the input is not active
- Analog: the input is analog for a specific measure programmed by tool configuration
- Digital NO: the input is digital type normally open
- Digital NC: the input is digital type normally closed

The parameter “Analog source” permits to choose if the oil pressure, engine temperature, rpm and battery voltage sources are directly from TCGEN2.0/ACGEN2.0 or via CANbus; the alarms are the same for both analog sources.

POS.	NAME	RANGE OF VALUES	DEFAULT SETTINGS
A	I4.4	Disabled – Digital NO – Digital NC	Digital NO
B	I4.5	Disabled – Digital NO – Digital NC	Digital NO
C	I4.6	Disabled – Digital NO – Digital NC	Digital NO
D	I4.7	Disabled – Digital NO – Digital NC	Digital NO
E	I4.8	Disabled – Digital NO – Digital NC	Digital NO
F	I6.2-Oil	Disabled – Analog – Digital NO – Digital NC	Analog
G	I6.3-Temperature	Disabled – Analog – Digital NO – Digital NC	Analog
H	I6.4-Fuel	Disabled – Analog – Digital NO – Digital NC	Analog
I	Analog source	TCGEN-Can ACGEN-Can	TCGEN2.0/ACGEN2.0

2.18-4 M8.4 – Output type

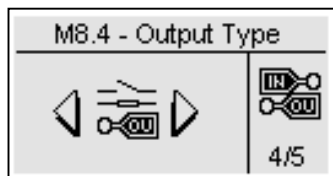

The output type setup permits to select the type of programmable outputs.

The outputs O5.8, O5.9, O5.10, O5.11 can be programmed as:

- Disabled: the output is not active
- Digital NO: the output is digital type normally open
- Digital NC: the output is digital type normally closed

The output O5.5 Start and O5.4 Ev can be programmed as:

- Disabled: the output is not active
- Digital NO: the output is digital type normally open

POS.	NAME	RANGE OF VALUES	DEFAULT SETTINGS
A	O5.8	Disabled – Digital NO – Digital NC	Digital NO
B	O5.9	Disabled – Digital NO – Digital NC	Digital NO
C	O5.10	Disabled – Digital NO – Digital NC	Digital NO
D	O5.11	Disabled – Digital NO – Digital NC	Digital NO
E	O5.4 Ev / O5.4 ICGEN	Disabled – Digital NO	Digital NO
F	O5.5 Start / O5.5 ICGEN	Disabled – Digital NO	Digital NO

2.18-5 M8.5 – Calibration

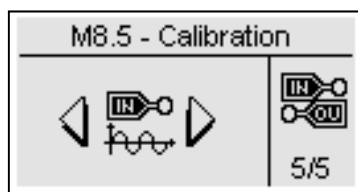

The measures setup allows to adjust the measured values for genset and mains voltages and load currents. For each voltage measure it's possible to set a calibration offset with steps of 0.1 V. For each current measure the offset is a percentage of the CT ratio, in steps of 0,1 %.

POS.	NAME	RANGE OF VALUES	DEFAULT SETTINGS
A	VL1 Gen	-100 +100 (V/10)	0
B	VL2 Gen	-100 +100 (V/10)	0
C	VL3 Gen	-100 +100 (V/10)	0
D	VL1 Mains	-100 +100 (V/10)	0
E	VL2 Mains	-100 +100 (V/10)	0
F	VL3 Mains	-100 +100 (V/10)	0
G	IL1	50.0 – 150.0 (%)	100
H	IL2	50.0 – 150.0 (%)	100
I	IL3	50.0 – 150.0 (%)	100

	Not for ACGEN2.0
	Not for ICGEN2.0



The Output setup permits to select the type of use of the programmable outputs.

The outputs O5.8, O5.9, O5.10, O5.11, O5.5 crank and O5.4 EV can be programmed as:

- None: no function associated to the output
- Siren: the output is used to command a siren that sounds when an alarm with siren enabled appears.
- Global alarm 1: the output is used to command an indication when an alarm set as general alarm 1 appears. The output remains active until you reset or the alarm disappears.
- Engine ON: the output is activated when the generator is running.
- Test active: the output is used to signal that the test is active.
- Refueling pump: the output is used to command the start and stop of a refueling pump. The parameters about the refilling functions can be set in the fuel menu.
- Dummy load: the output is used for the dummy load function. To have more information about this function, see menu 2-8.3.
- Reset mode: indicates that the controller is in reset mode
- Auto mode: indicates that the controller is in automatic mode
- Man mode: indicates that the controller is in manual mode
- Global alarm 2: the output is used to command an indication when an alarm set as general alarm 2 appears. The output remains active until you reset or the alarm disappears.
- Global alarm 3: the output is used to command an indication when an alarm set as general alarm 3 appears. The output remains active until you reset or the alarm disappears.
- KG ON: indicates that the generator contactor is closed
- KR ON: indicates that the mains contactor is closed
- Global alarm pressure: indicates that one alarm about the oil pressure is active
- Global alarm temperatures: indicates that one alarm about the engine temperature is active
- Global alarm level: indicates that one alarm about the fuel level is active

POS.	NAME	RANGE OF VALUES	DEFAULT SETTINGS
A	Enable	On to enable communication between TCGEN2.0 and expansion board	Off
B	Bitrate (bps)	Change the serial speed value for expansion board. To activate the new port speed the expansion must be switch off. At the new startup the serial port will be ready at the new speed value: 1 = Set 9600 bps 2 = Set 19200 bps 3 = Set 38400 bps (expansion def.) 4 = Set 57600 bps 5 = Set 115200 bps	0 (expansion def.)
C	Timeout (s)	Set the timeout delay on communication between TCGEN and expansion board: Set the value from 1 to 255 (s), 0 is the expansion default value which is 5 s.	0 (expansion def.)
D	ExOut_0	None – Siren – Global alarm 1 – Engine running – Test active – Refuelling pump – Dummy load – Reset mode – Auto mode – Man mode – Global alarm 2 – Global alarm 3 – KG ON – KR ON – Global alarm pressure – Global alarm temperature – Global alarm level	None
E	ExOut_1	Same as parameter A	None
F	ExOut_2	Same as parameter A	None
G	ExOut_3	Same as parameter A	None
H	ExOut_4	Same as parameter A	None
I	ExOut_5	Same as parameter A	None
J	ExOut_6	Same as parameter A	None
K	ExOut_7	Same as parameter A	None

APPENDIX

Appendix A: Fuel sensor curves / Only for ACGEN2.0 & TCGEN2.0

Fuel level value (%)	VDO-Ohm	VEGLIA-Ohm	DATCON-Ohm
0	10	304	240
5	20	279	223
10	31	254	206
15	42	229	190
20	52	205	173
25	61	181	159
30	70	159	146
35	79	137	135
40	88	116	124
45	97	97	114
50	105	80	105
55	113	65	97
60	121	51	89
65	129	40	82
70	137	30	75
75	144	22	69
80	152	15	62
85	159	10	55
90	167	7	49
95	174	4	38
100	181	2	27
105	188	0	15

Appendix B: Oil pressure sensor curves / Only for ACGEN2.0 & TCGEN2.0

Oil pressure value	VDO-ohm	VEGLIA-ohm	DATCON-ohm
0	10	305	240
0,100	18	285	227
1	27	264	213
1,200	35	243	199
1,799	47	214	180
2	51	204	174
2,200	55	196	168
2,799	66	166	152
3	70	157	146
3,200	73	148	141
3,799	84	122	127
4	87	114	123
4,199	91	107	119
4,800	101	87	107
5	105	81	103
5,199	108	75	100
5,800	119	58	91
6	122	53	88
6,199	126	48	85
6,800	135	35	77
7	138	31	75
7,199	141	28	72
7,800	150	16	64
8	153	12	62
8,199	156	12	60
8,800	164	12	52
6	122	53	88
6,199	126	48	85
6,800	135	35	77
7	138	31	75
7,199	141	28	72
7,800	150	16	64
8	153	12	62
8,199	156	12	60
8,800	164	12	52
9	167	12	50
9,199	170	12	47
9,800	178	12	40
10	181	12	37

Appendix C: Temperature sensor curves / Only for ACGEN2.0 & TCGEN2.0

Engine temperature value	VDO-ohm	VEGLIA-ohm	DATCON-ohm
24	605	1050	650
28	530	1050	650
32	455	1050	650
36	380	1050	650
40	325	1050	650
44	277	935	586
48	237	815	520
52	200	695	455
56	170	585	398
60	145	495	345
64	123	425	300
68	104	365	262
72	90	320	229
76	75	280	200
80	65	245	172
84	57	210	147
88	50	185	126
92	44	160	109
96	38	140	93
100	35	125	80
104	31	110	70
108	28	100	63
112	26	93	58
116	24	87	54
120	22	80	49
124	20	73	45
128	18	67	41
132	17	60	38
136	16	55	34
140	15	50	30



CRE TECHNOLOGY

130 allée Charles-Victor Naudin
Zone des Templiers
Sophia-Antipolis
06410 BIOT
FRANCE

Phone: +33 (0)4 92 38 86 82

Fax: +33 (0)4 92 38 86 83

Website: www.cretechnology.com

Email: info@cretechnology.com

Technical support: +33 (0)4 92 38 86 86 (office hours: 8.30AM - 12AM / 2PM - 6PM GMT +1)

Email: support@cretechnology.com

SKYPE: [support-cretechnology.com](https://www.skype.com/join/support-cretechnology.com)

Check our entire distributors list around the world on www.cretechnology.com tab «DISTRIBUTORS»

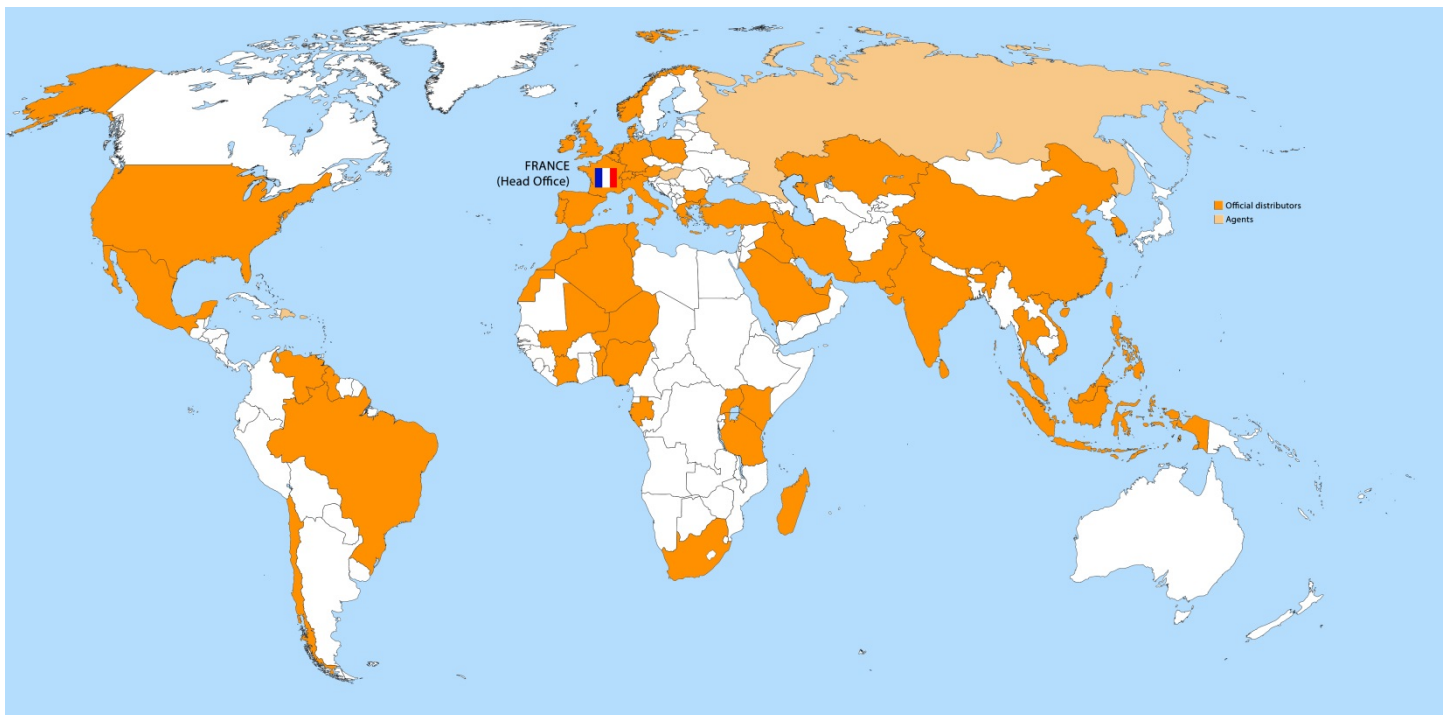

CRE TECHNOLOGY retains all copyrights in any text, graphic images and softwares owned by CRE TECHNOLOGY and hereby authorizes you to electronically copy documents published herein solely for the purpose of transmitting or viewing the information.