

Product Overview

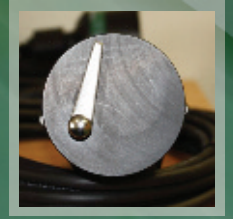
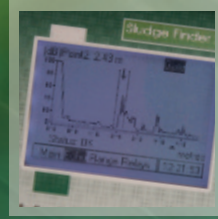

Sludge Finder 2

Sludge Finder 2

Is a proven effective sludge blanket interface monitor in both waste water and industrial applications. Sludge Finder 2 provides a continuous level indication and 4 – 20 mA output of interface height from the tank bottom along with relays for alarm or control use . Sludge Finder 2 monitors SBR tanks, primary or secondary settlement tanks down to 0.5% density.

Prompt Led Set Up

Easy drop down menu allows quick set up, the clear large display offers a choice of menus and the interface echo can be constantly seen if needed.

Self Cleaning Viper Transducer

The Viper transducer complete with a sweep clean wiper removes dirt and air from the transducer face. A second transducer may be added to the controller giving two channel ability if needed. The second transducer may be a through air ultrasonic unit, enabling the second channel to monitor level of liquid or solids, particularly useful in mineral or mining applications.

Sludge Finder 2:

Sludge interface monitor

Features

- Continuous single or dual channel level control choice
- High frequency gives high reliability long term
- Self cleaning transducer removes need for regular inspection
- SBR tank applications can be monitored
- Easy set up, via drop down menu on large clear display

Pulsar's Sludge Finder 2 is a versatile, accurate and reliable solution to the problem of accurately measuring interface levels in primary or secondary settlement tanks and SBR systems. Operating ultrasonically through liquid, Sludge Finder 2 uses proven echo processing algorithms to identify the sludge interface level by state of the art digital echo processing techniques found only in this unit.

Sludge Finder 2's unique Viper transducer is immersed in the liquid, emitting a high frequency ultrasonic pulse down towards the sludge interface. The pulse reflects from the interface of the denser material back to the Viper transducer face. This echo is analysed by the controller unit providing a depth reading and an analogue output proportional to the height of the interface above the vessel bottom.

Sludge Finder 2 uses a self-cleaning underwater acoustic sensor that results in continuous, reliable sludge level measurement. You can reduce sludge pumping, optimise dosing and let your staff concentrate on other things.

Multiple Tanks, Multiple Applications

Sludge Finder 2 will operate with one or two transducers: you can mix and match Sludge Transducers and Pulsar's main dB transducer range to give astonishing versatility. Manage two clarifiers/thickeners, or one clarifier plus an ultrasonic level application from a single unit, providing flexible, economical control and a single connection point for system interface.

Sludge Finder 2 features a microprocessor and a multifunction display showing blanket level, complete echo profile, alarm points, tank depth and multiple tank status.

Use Sludge Finder 2 in:

- Primary and secondary settlement tanks
- Clarifiers
- Stationary and travelling bridge applications
- Gravity thickeners
- Reactor clarifiers
- DAF thickeners
- Sequential batch reaction tanks
- Industrial process thickeners

Versatile outputs

Sludge Finder 2 features 4-20mA isolated outputs for each channel, with optional RS485 connection (Modbus or Profibus). Six control relays are included (5A rated), independently assignable to any channel. An optional radio modem with a 500m line-of-sight range may also be specified.

The hygienic solution

Remote measurement with Sludge Finder 2 means you can put an end to tedious, time consuming, potentially unhygienic and hazardous manual measurements using gap switches or vacuum probes.

Self-cleaning transducer

Sludge Finder 2 is designed to be maintenance free. Sludge Finder's Viper transducer is a single beam ultrasonic unit immersed just below the liquid surface. A wiper blade sweeps the transducer face, ensuring that it remains clean. The Viper transducer may be positioned up to 200m from the control unit and has a measurement range of 0.3 to 10m.

Accuracy is 0.25% of the measured range. A tight 6° beam angle and sophisticated echo processing algorithms makes sure that

Sludge Finder 2 deals with difficult tanks and rotating equipment with ease.



Sludge Finder 2:

Prompt led set-up

Easy installation and set-up

Sludge Finder 2 is simply installed and the transducer cable can be easily extended with twin pair screened cable. To program Sludge Finder 2, the operator enters operating parameters via a menu driven operator interface and the Sludge Finder 2 automatically tracks to the blanket interface. Sludge Finder 2's operator interface consists of several screens that make setting up the unit straightforward and communicates information about the process quickly, clearly and concisely.

TYPICAL SCREEN SHOTS THROUGH MENU

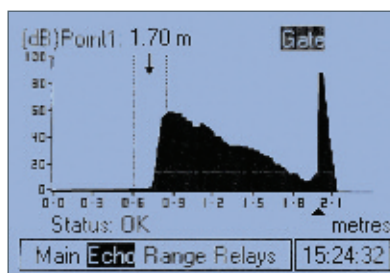
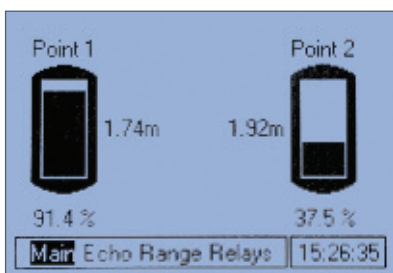
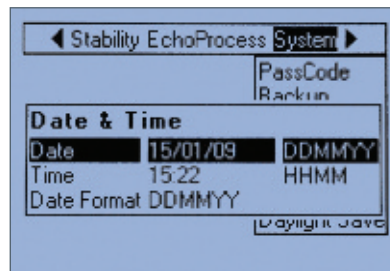
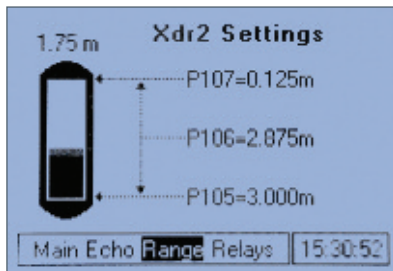
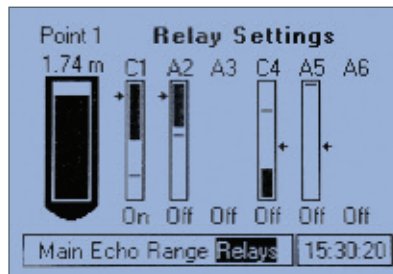
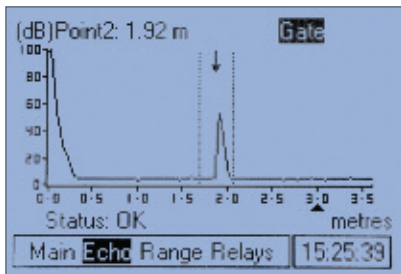
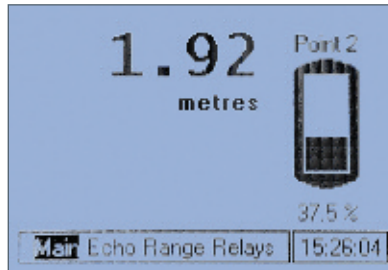

Features

- Relay choices for alarm or pump control function
- Reliable monitoring down to 0.5% density
- Second transducer may be interface Viper transducer or an air transducer for liquids or solids level measurement
- 200m separation distance between Viper and controller using standard cable

A TYPICAL ECHO PROFILE VIEWED ON OPTIONAL SLUDGE PC SOFTWARE

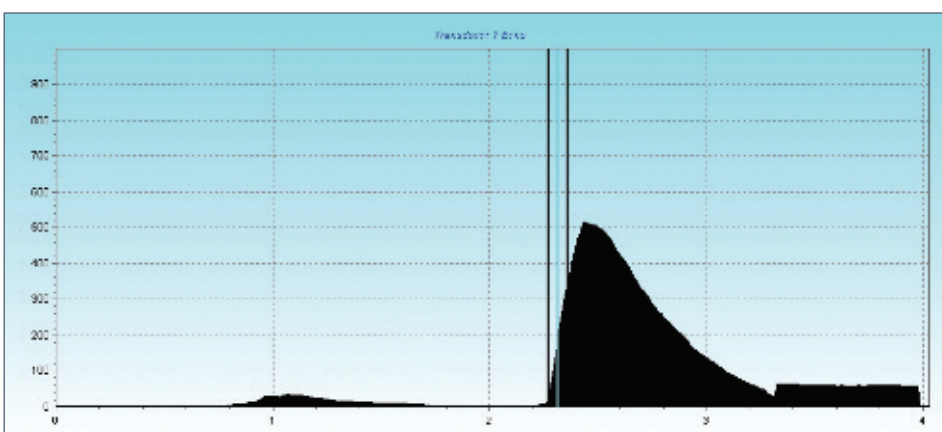

Sludge Finder 2:

Viper Transducer

Features

- Self-cleaning transducer reduces maintenance
- Keeps algae and other growth off the face
- Flexible transducer arm option, allows rotating bridges to be used
- Mounting bracket options available

Self-cleaning transducer

The Viper transducer is designed to operate continually immersed in liquid, and features an oscillating wiper blade to keep the face free of algae or bacterial growth that could otherwise affect performance. The wiper also effectively clears air bubbles from the transducer face, while the 0.2mm gap between the wiper and the transducer face makes sure there is no wear between the surfaces.

The sweep action of the wiper discourages 'hair' build up, ensuring that the shaft does not lock up over time.



VIPER MOUNTED BEHIND SURFACE SKIMMER AND IN FRONT OF ROTATING BRIDGE



FRONT VIEW OF VIPER FACE SHOWING WIPER

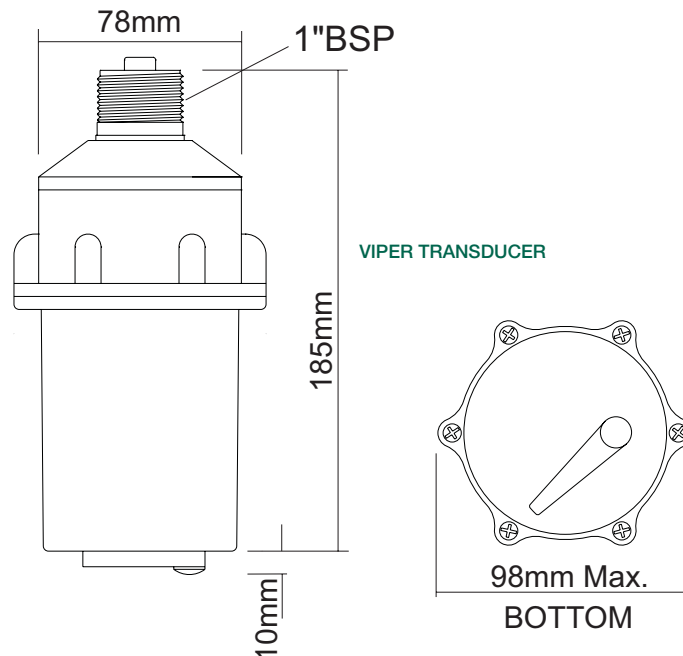

Technical Specification: Sludge Finder 2

PHYSICAL:

Wall Mount:	
External dimensions:	235 x 184 x 120 mm
Weight Nominal:	1 kg
Enclosure material/description:	Polycarbonate, flame resistant to UL94-5V
Cable entry detail:	10 cable entry knock outs, 5 x M20 and 1 x M16 underside, 4 x PG11 at rear
Transducer cable extensions:	2 x twin pair with overall screen
Maximum separation:	200 m from transducer to transceiver

ENVIRONMENTAL:

IP Rating (Wall):	IP65
Max. and min. temp. (electronics):	-20 °C to +50 °C
CE approval:	2004/108/EC EMC approval 2006/95/EC low voltage directive

SONAR (INTERFACE) PERFORMANCE:

Accuracy:	0.25% of the measured range or 10 mm (whichever is greater)
Resolution:	0.25% of the measured range or 10 mm (whichever is greater)
Max. range:	10m
Min. range:	0.3m

NB: Please refer to separate literature for dB transducer performance if using an 'air' application.

OUTPUTS:

Viper material:	Body in black Valox 357 with a 316 wiper blade and shaft
Analogue output:	2 off Isolated output (to 150V) of 4-20 mA or 0-20 mA into 1kΩ (user programmable and adjustable) 0.1% resolution
Serial output:	Half Duplex RS232
Volt free contacts:	6 form "C" (SPDT) rated at 5A at 240V AC
Display:	192 x 128 pixel illuminated graphical display. Fully programmable display options. Integral keypad with menu navigation keys
Radio Modem (optional):	4 - 20mA using wireless exempt frequencies
Maximum range:	500m line of site
Communication bus (optional):	RS485 Modbus RTU/ASCII or Profibus DP V0 or V1

PROGRAMMING:

On-board programming:	By integral keypad
PC programming:	Via RS232 RJ11 port
Programming security:	Via passcode (user selectable and adjustable)
Programmed data integrity:	Non-volatile memory

SUPPLY:

Power supply:	Universal 100 - 240VAC 50/60Hz DC 22 - 28V 14W maximum power (typically 11W) Fuse 2A slow blow
----------------------	---

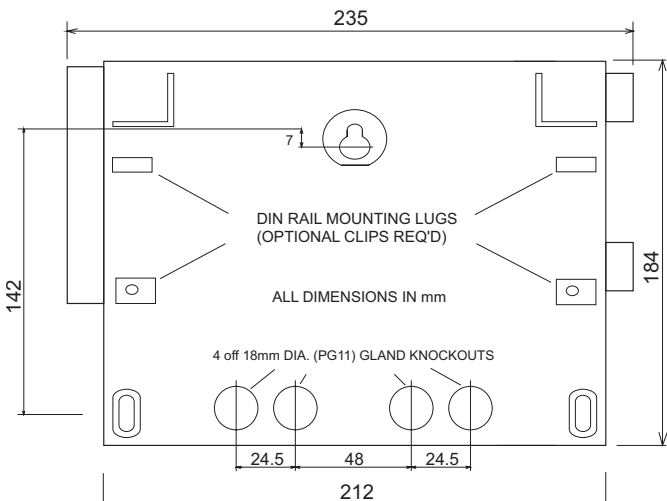

ENCLOSURE DIMENSIONS AND KNOCKOUT DETAILS

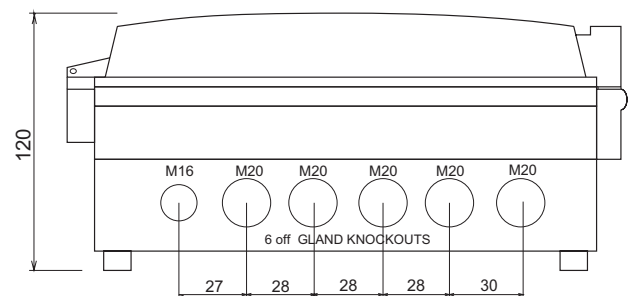

Notes:

Pulsar® Process Measurement Ltd.

Cardinal Building
Enigma Commercial Centre
Sandy's Road
Malvern
Worcestershire
WR14 1JJ
England
Tel: +44 (0) 1684 891 371
Fax: +44 (0) 1684 575 985
Email: info@pulsar-pm.com

Pulsar® Process Measurement Inc.

P.O. Box 5177
4565 Commercial Drive
Suite 105
Niceville
FL 32578
USA
Tel: +1 850 279 4882
Fax: + 1 850 279 4886
Email: info.usa@pulsar-pm.com

www.pulsar-pm.com



Pulsar Process Measurement Limited operates a policy of constant development and improvement and reserves the right to amend technical details as necessary