

Closed Spelter Sockets

G-417 / S-417



Closed grooved Sockets meet the performance requirements of Federal Specification RR-S-550E, Type B, except for those provisions required of the contractor. For additional information, see page 444.

- Forged Steel Sockets through 38mm, cast alloy steel 40mm through 100mm.
- Spelter socket terminations have an efficiency rating of 100%, based on the catalog strength of wire rope. Ratings are based on the recommended use with 6 x 7, 6 x 19 or 6 x 37, IPS or XIP (EIP), XXIP (EEIP), RRL, FC or IWRC wire rope. Strand constructed with minimal number of wires (e.g. 1 x 7) requires special consideration that socket basket length be five (5) times the strand diameter or fifty (50) times the wire diameter, whichever is the greater.

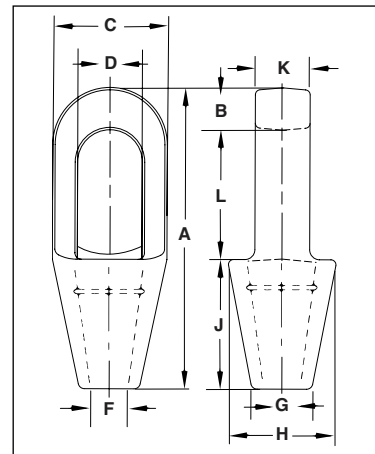

NOTICE: All cast steel sockets 40mm and larger are magnetic particle inspected and ultrasonic inspected. Proof testing available on special order.

Drawing illustrates one groove used on sockets 6mm through 18mm. Sizes 20mm through 38mm use 2 grooves. Sizes 40mm and larger use 3 grooves.

G-417 / S-417 Closed Spelter Sockets

Rope Dia.		Structural Strand Dia. (mm)	Ultimate Load (t)	Stock No.		Weight Each (kg)	Dimensions (mm)									
(mm)	(in.)			G-417 Galv.	S-417 S.C.		A	B	C	D*	F	G	H	J	K	L
6-7	1/4	-	4.50	1039897	1039904	.23	116	12.7	39.6	22.4	9.65	17.5	39.6	57.2	12.7	46.0
8-10	5/16 - 3/8	-	12.0	1039913	1039922	.34	125	15.8	42.9	24.6	12.7	20.6	42.9	57.2	17.5	52.3
11-13	7/16 - 1/2	-	20.0	1039931	1039940	.68	140	17.5	51.0	29.5	14.2	23.9	51.0	63.5	22.4	58.7
14-16	9/16 - 5/8	12-13	30.8	1039959	1039968	1.13	162	20.6	67.0	35.8	17.5	30.2	67.0	76.2	25.4	65.0
18	3/4	14-16	43.5	1039977	1039986	1.92	194	26.9	76.2	42.2	22.4	33.3	70.0	89.0	31.8	77.7
20-22	7/8	18-19	65.3	1039995	1040000	3.28	226	33.3	92.0	49.3	25.4	38.1	82.5	102	38.1	90.5
24-26	1	20-22	81.6	1040019	1040028	4.76	254	36.6	105	58.5	28.7	44.5	95.5	114	44.5	103
28-30	1-1/8	24-26	100	1040037	1040046	6.46	283	39.6	114	65.0	31.8	51.0	105	127	51.0	116
32-35	1-1/4 - 1-3/8	28	136	1040055	1040064	8.95	309	41.4	127	71.0	38.1	58.5	119	138	56.5	129
38	1-1/2	30-32	170	1040073	1040082	13.24	355	49.3	137	81.0	41.4	70.5	132	151	62.5	155
† 40-42	† 1-5/8	33-35	188	1040091	1040108	16.32	390	54.0	146	82.5	44.5	76.2	140	165	70.0	171
† 44-48	† 1-3/4 - 1-7/8	36-40	268	1040117	1040126	25.96	445	55.5	171	95.5	51.0	79.5	162	191	76.2	198
† 50-54	† 2 - 2-1/8	42-45	309	1040135	1040144	35.83	505	62.0	194	111	57.2	95.5	187	216	82.5	224
† 56-60	† 2-1/4 - 2-3/8	46-48	360	1040153	1040162	47.62	546	70.0	216	127	66.8	105	210	229	92.0	248
† 64-67	† 2-1/2 - 2-5/8	50-54	424	1041759	1041768	63.50	597	79.5	241	140	74.5	114	235	248	102	270
† 70-73	† 2-3/4 - 2-7/8	56-62	549	1041777	1041786	99.79	645	79.5	273	159	79.5	124	259	279	124	286
† 75-80	† 3 - 3-1/8	64-67	656	1041795	1041802	125	689	85.6	292	171	86.0	133	292	305	133	298
† 82-86	† 3-1/4 - 3-3/8	70-73	750	1041811	1041820	142	743	102	311	184	92.0	146	311	330	146	311
† 88-92	† 3-1/2 - 3-5/8	76-80	820	1041839	1041848	181	787	102	330	197	98.5	160	330	356	159	330
† 94 - 102	† 3-3/4 - 4	-	1005	1041857	1041866	246	845	108	362	216	108	184	362	381	178	356

* Diameter of pin must not exceed pin used on companion 416 socket. Reference adjacent page "D" dimension.

† Cast Alloy Steel.