



Digital Cameras for Microscopes



DIGITAL CAMERAS FOR MICROSCOPES

DIGITAL SIGHT SERIES

Nikon Digital Sight Series New Lineup

A new system for imaging: the DS-Fi3, a high resolution and sensitivity general purpose color camera has been added to the Nikon Digital Sight series. The DS-Fi3 can be connected to a PC, or the new compact tablet-style DS-L4.



Microscope Camera

DS-Fi3



5.9
megapixel

Color

High-
resolution

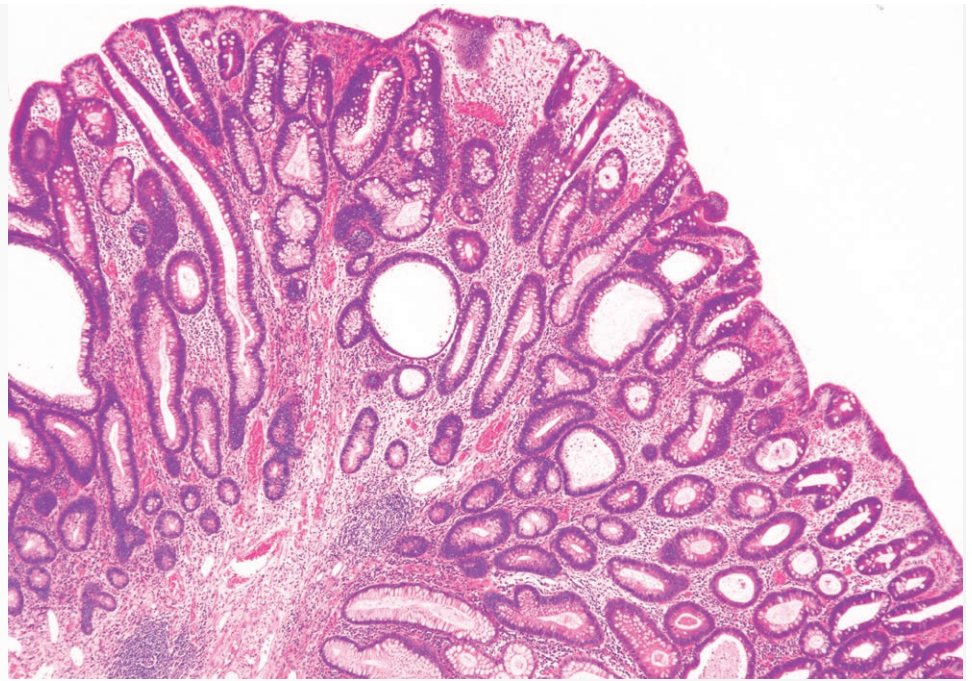

Tubular adenoma, HE staining (Objective: CFI Plan Apochromat λ 4x)
Photos courtesy of: Dr. Yasunori Ohta, Department of Pathology, IMSUT Hospital,
Institute of Medical Science, The University of Tokyo

High-resolution images

A CMOS high density 5.9 megapixel sensor produces high resolution images. USB3.0 data transfer allows fast focusing at high resolution, and easy capture images in all types of observation methods such as brightfield, differential interference contrast, and phase contrast.

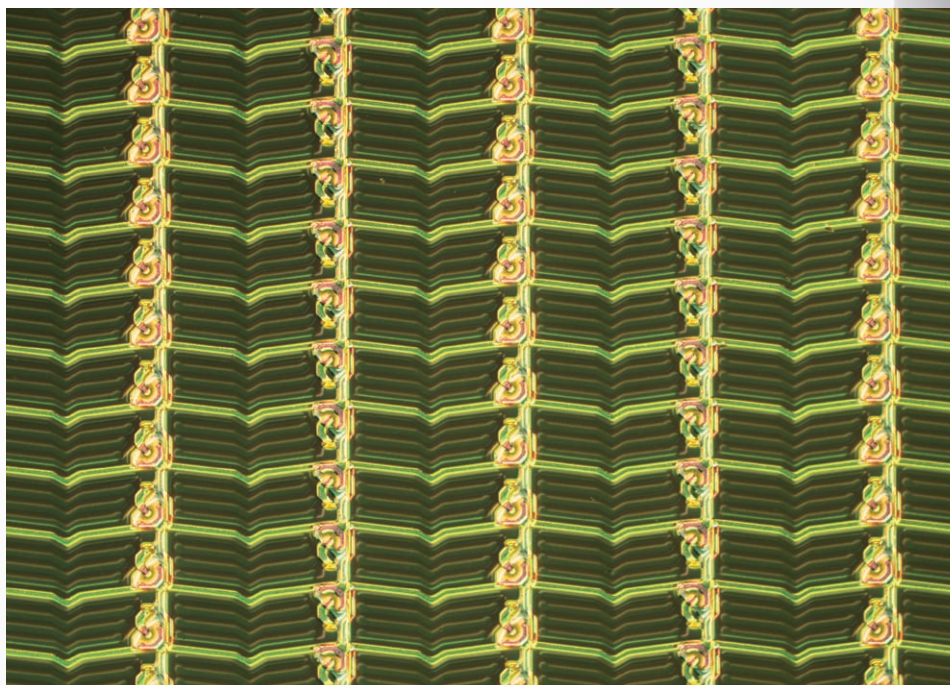

Liquid crystal panel
(Objective: TU Plan Fluor 10x)

DS-Fi3

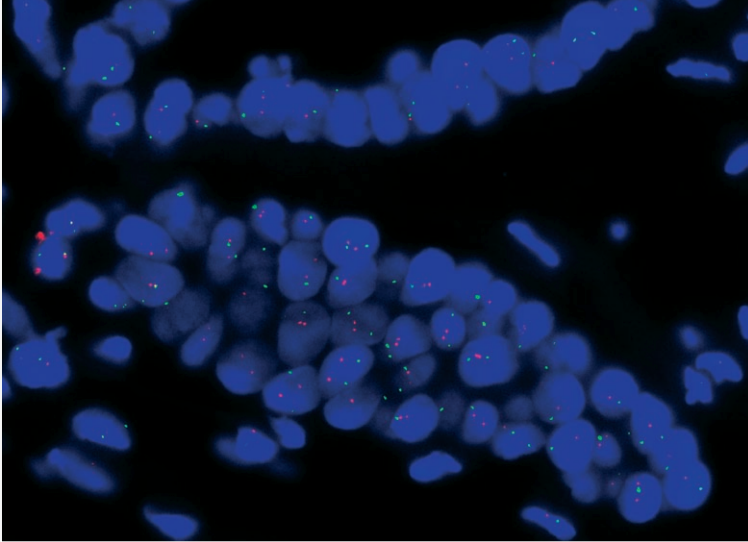

Breast cancer, FISH method (Objective: CFI Plan Apochromat 100x Oil)
Photos courtesy of: Hironao Kusakari, Diagnostic Pathology, St. Marianna University Hospital

High sensitivity, low noise

Quantum efficiency and read noise have been greatly improved, providing better capability for acquisition of fluorescent images with better signal-to-noise ratios than before.

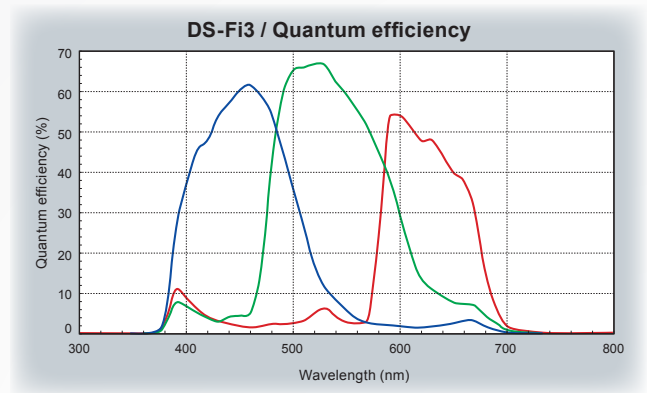

High-speed live display

Fast USB3.0 data transfer means fast, smooth live updating of images for finding samples or focusing, even at full resolution.

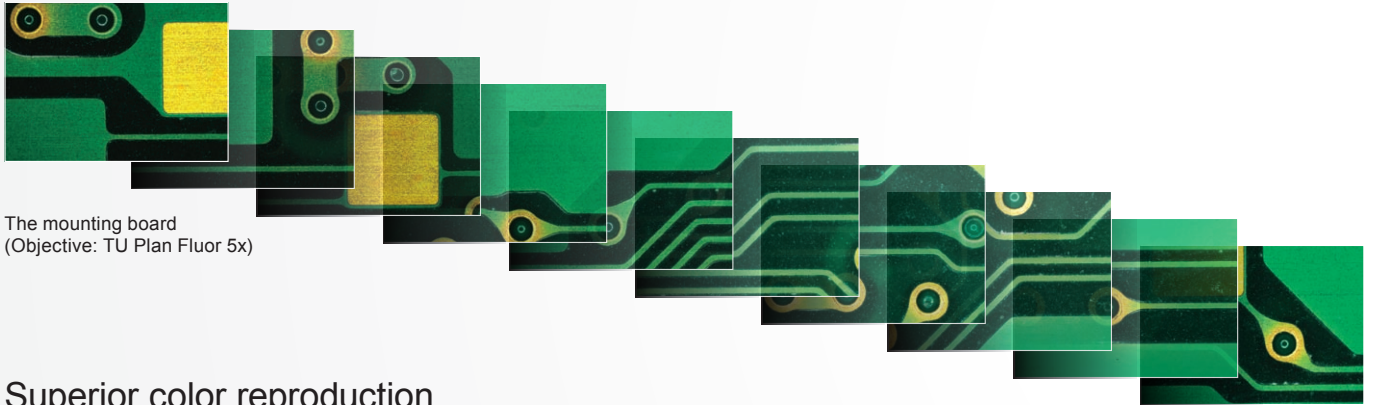

The mounting board
(Objective: TU Plan Fluor 5x)

Superior color reproduction

Nikon is well-known for outstanding and lifelike color reproduction, and developing superior algorithms for creating results that look like the actual samples. These algorithms are used in all of the color cameras in the digital sight lineup.

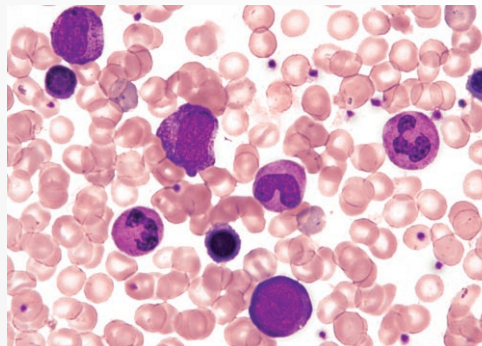
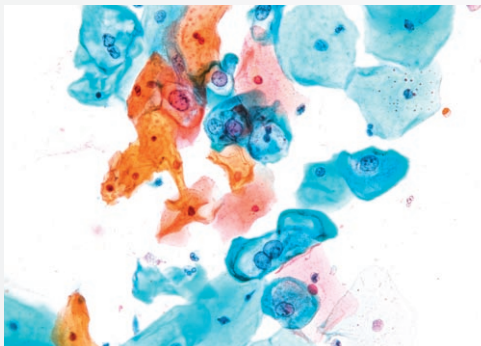

Left image: Uterine cervix Pap. Staining
(Objective: CFI Plan Apochromat λ 40x)
Photos courtesy of: Kazuhiro Mita, Department of Pathology, Yokohama City University Hospital

Right image: Bone marrow
(Objective: CFI Plan Achromat NCG 40x)
Photos courtesy of: Clinical Laboratory Department, Yokohama City University Hospital

Camera Control

The DS-Fi3 interfaces with PC computers via a USB3.0 interface directly to the camera head, and uses NIS-Elements series software for image acquisition.

Microscope Camera Control Unit DS-L4

Compact, easy-to-use tablet-type microscope camera control unit.

DS-Fi3 and DS-Ri2 can be optionally connected to the DS-L4 tablet-style control unit, eliminating the need and space requirements of a desktop PC. DS-L4 has a large number of built-in functions for measurement and annotations, and has built-in security for network connectivity.



Tablet-type camera control unit

Large, 10.1 inch, touch-screen 1920 × 1200 pixel display: The DS-Fi3 can be set and operated simply and easily through the tablet by touch, or by connecting Bluetooth accessories such as a keyboard or mouse.

User Interface for naturally simple operation

The camera control menu uses recognizable and intuitive icons. Frequently used icons are in two rows, and the display space for live images and photographed images is large and prominently displayed.

Live menu/Replay menu



Integration with microscopes

Optimal imaging parameters for the microscope's light source, (LED or halogen), each sample type, and observation method can easily be set through the icons. A choice of three modes for biological and four modes for industrial imaging are available, and up to seven custom modes with freely configurable shooting parameters can be set.

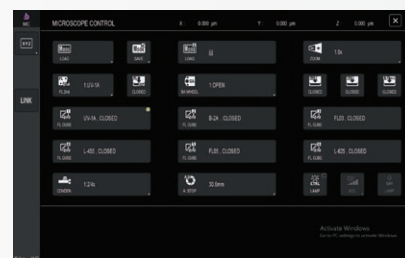

Used with ECLIPSE Ni-E

A wide variety of tools

The DS-L4 enables easy measurements directly on images, with input of lines and comments. These can also be written and saved with the image, and measurement data can also be output.

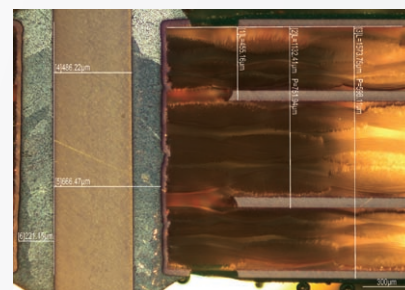

Measurement (2 point distance)

Scene mode

When connected to biological, industrial, or stereoscopic microscopes equipped with motorized hardware units and observation mode sensors, it is possible to both control the microscope and detect its observation mode state. Storing the objective lens information is convenient when making measurements.

Biological Scene Mode

BF Brightfield HE HE ELISA ELISA

Industrial Scene Mode

Wafer/IC Metal, Ceramic/Plastic
Circuit board Flat Panel Display

Tighten security

McAfee embedded control with White List method is preinstalled for the virus measurement.

The program which is not registered at White List cannot be launched so that the virus cannot be activated.

Only registered users are able to use by implementing user registration.

Those security protect the important images.

Two Large Sensor high resolution 16.25-megapixel CMOS image sensors for microscopy

Two Nikon FX-format CMOS image sensor cameras join the Digital Sight series of microscope digital cameras: the DS-Ri2 color digital camera and the DS-Qi2 monochrome digital camera.

High pixel density and large field of view coupled with USB3.0 high speed data transfer offer fast frame rates and high resolution images with these CMOS image sensors.



Large Format CMOS image sensors

Nikon manufactures CMOS image sensors and imaging technologies for professional DSLR cameras, and now has optimized our sensors for microscopy

DS-Qi2

High pixel density, high sensitivity and low noise are key features of the DS-Qi2 monochrome camera.

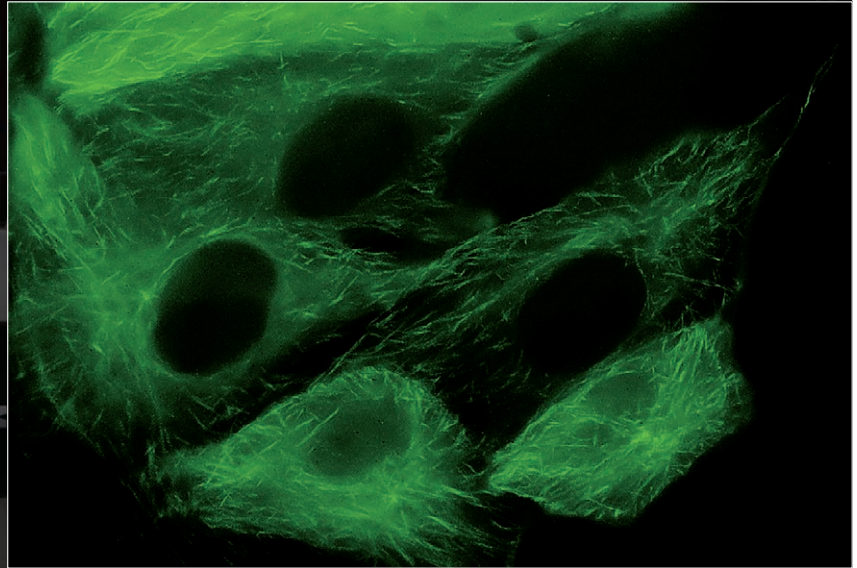

Pig kidney epithelial cells expressing GFP-EB3 tubulin
Sample courtesy of: Michael Davidson, National High Magnetic Field Laboratory,
Florida State University

DS-Ri2

16.25 megapixel (not interpolated) and accurate color rendition are features that make the DS-Ri2 an excellent choice for recreating color images as they eyes see them.

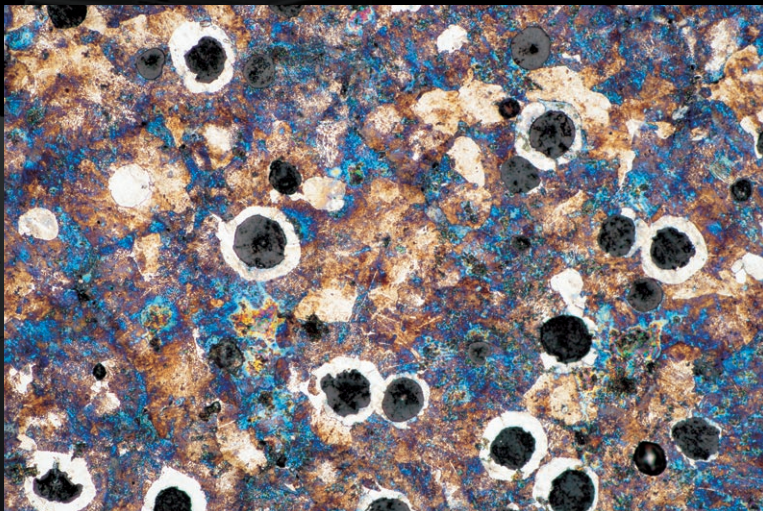

Malleablecastiron (Objective: TU Plan Fluor 20x)

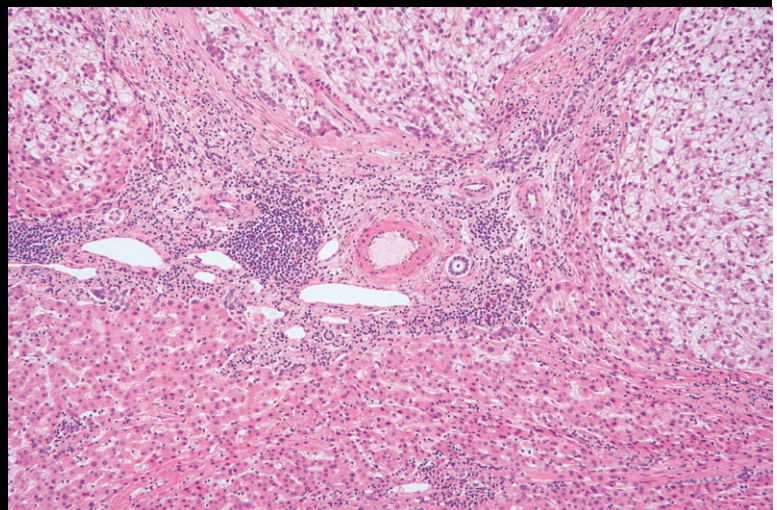

The tissues of the liver, HE staining (Objective: CFI Plan Apochromat λ 10x)
Photos courtesy of: Kazuhiro Muraoka, Photography Division, Tokyo Women's Medical University

Fast, one-shot capture of ultra-high resolution color images.

Microscope Camera

DS-Ri2

16.25 megapixel

Color

High-resolution

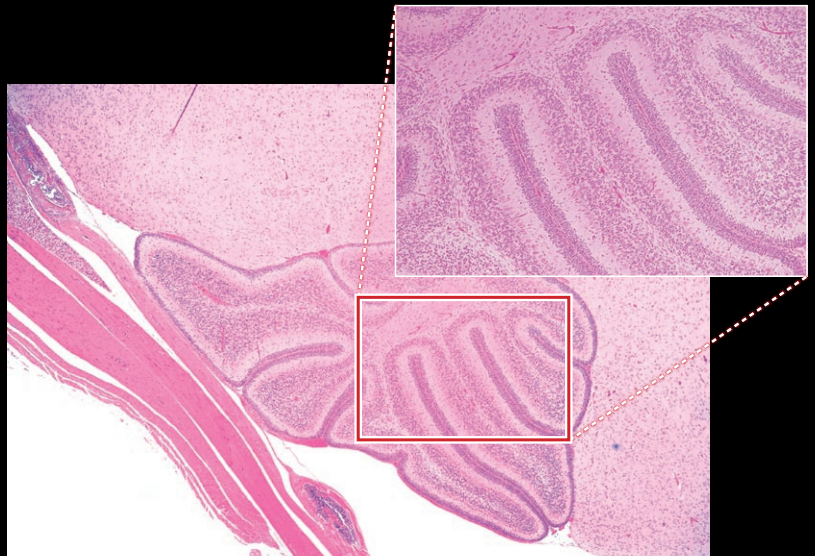

Mouse cerebellum sagittal section, HE staining (Objective: CFI Plan Apochromat λ 4x)

High-resolution images

16.25-megapixel CMOS image sensors for astonishing image quality

The DS series enables one-shot instantaneous capture and fast storage of images with resolution as high as 4908 x 3264 pixels, without pixel shifting or pixel stepping.

This pixel density is ideally suited for photomicrography of ultra-fine structures or patterns in biological or industrial samples, at low or high magnifications.

Photography with the natural colors seen through the microscope

Nikon is a leader in development of algorithms for reproducing color just as the eyes see it

The DS models' image processing engine is based on extensive data accumulated over many years of developing microscope color digital cameras, resulting in perfect reproduction of the colors your eyes see in the microscope.

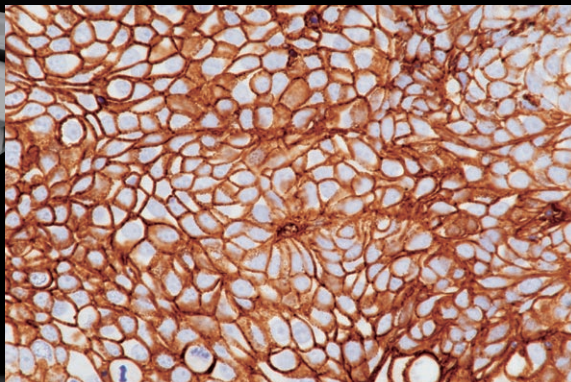

Pancreatic cancer cell, NGFR immunostaining*1
(Objective: CFI Plan Apochromat λ 40x)

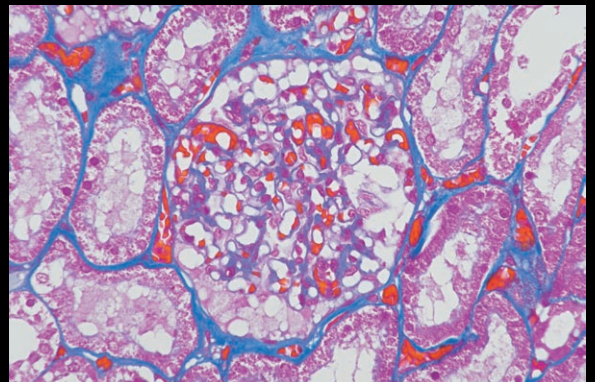

Human glomerulus of kidney, Azan stain*2
(Objective: CFI Plan Apochromat λ 40x)

*1, *2 Photos courtesy of: Dr. Atsushi Furuhashi and Noriyoshi Sueyoshi, Assistant General Manager, Laboratory of morphology and image analysis, BioMedical Research Center, Juntendo University Graduate School of Medicine

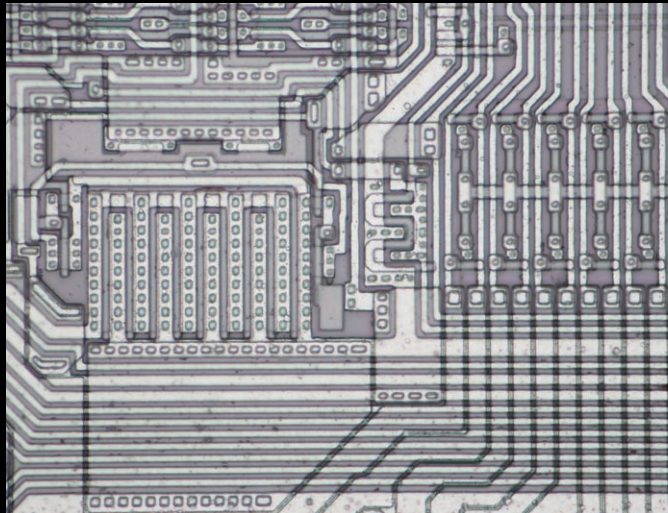

Semiconductors (IC wafers)
(Objective: TU Plan Fluor 20x)

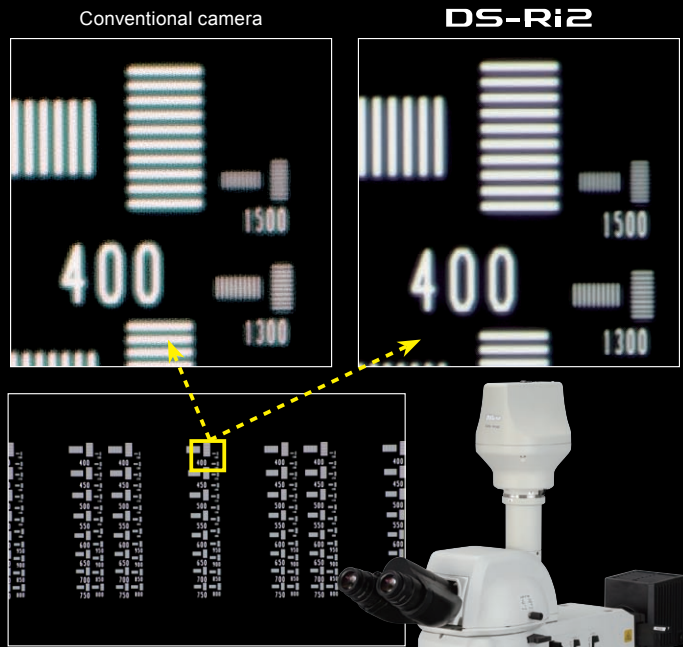

Resolution chart
(Objective: TU Plan Fluor 20x)

High-speed live display

High-speed display, even of supra-HDTV-class live images

The DS-Ri2 can display 4908×3264 pixel (full-pixel) images at 6 fps, or 1636×1088 pixel (3×3 pixel averaging) images at 45 fps.

This fastlive frame rate makes fine focusing easy to perform.

Example of combination with the LV100ND industrial microscope



Semiconductors (IC wafers)
(Objective: TU Plan Fluor 5x)
1636×1088 pixel / Exposure time: 100μsec

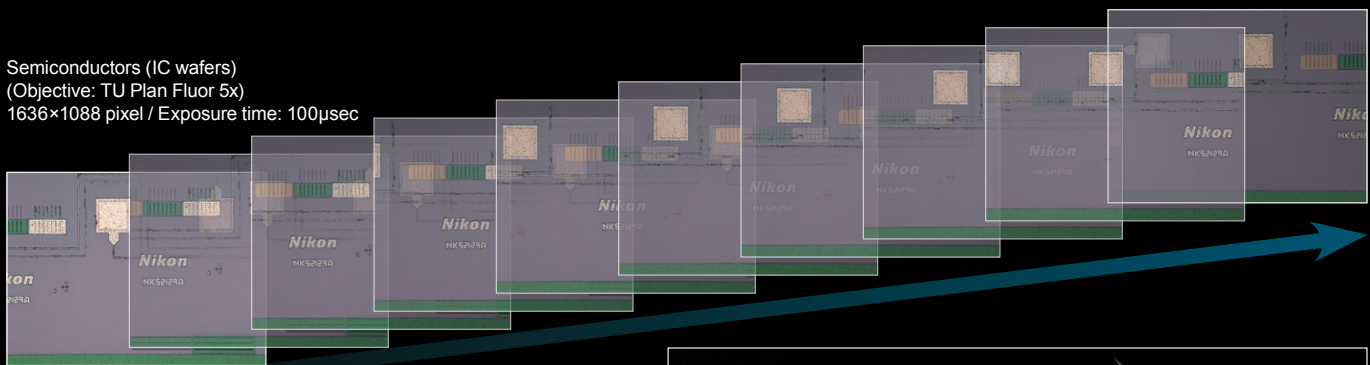

High sensitivity, low noise

Fluorescent color image capture with high signal to-noise ratio

Sensitivity settings that span the range from ISO200 to ISO12800 allow the capture of vivid fluorescent color images.

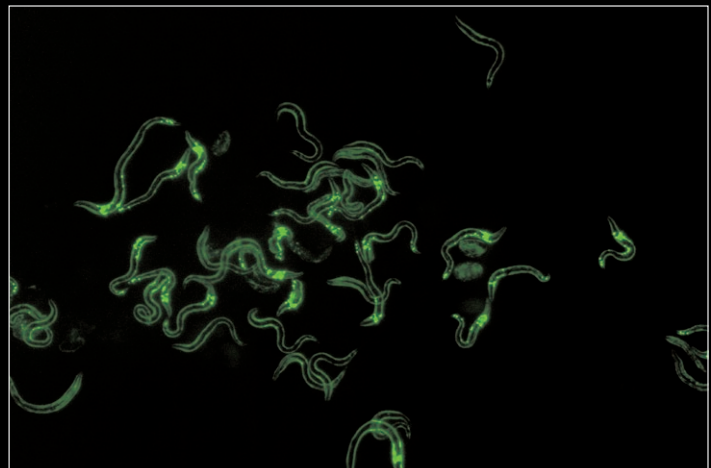

Transgenic *C. elegans* expressing venus in the head neurons and EGFP in the body wall muscles.
Photos courtesy of: Drs. Keiko Gengyo-Ando and Junichi Nakai, Saitama University Brain Science Institute

Capture Low light fluorescence and Large Fields of View

Monochrome Microscope Camera

DS-Qi2

16.25 megapixel

Monochrome

Cooled

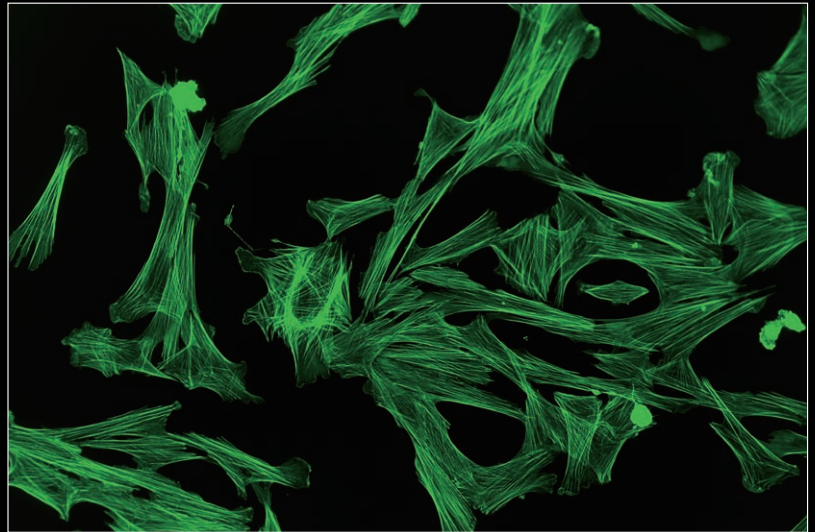

Indian Muntjac Deer Skin Fibroblast Cells, Cytoskeletal F-actin labeled with Alexa Fluor 488
Sample courtesy of: Michael Davidson and Florida State University

High sensitivity

Detects even faint fluorescent signals

7.3 μ m pixels, high quantum efficiency, and very low read noise allow the DS-Qi2 to read in even faint fluorescent signals.

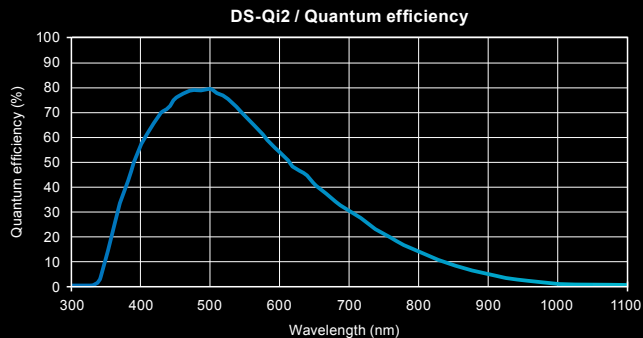

Excellent linearity

Reliable quantitative analysis made possible

With a linearity error of $\pm 1\%$, the DS-Qi2 is a superb tool for measuring intensities in fluorescence samples, including time-based intensity measurement and ratiometric measurement.

High frame rate

Fast focusing, even with fluorescent images

With a high-sensitivity CMOS image sensor and USB 3.0-based data transfer, the DS-Qi2 enables high-speed live imaging and image capture at up to 45 fps (1636 \times 1088 pixels).

Low noise

Acquires dim fluorescent signals with ultra-low noise

Both 2.2 electrons read noise coupled with a large full-well capacity and 0.6 electrons dark current allow the acquisition of 14bit fluorescence images with very little noise.

LLC-PK1 cells expressing GFP-EB3 tubulin with low noise. Large linear full well capacity allows acquiring both the brightest and dimmest areas in a single capture.

Sample courtesy of: Michael Davidson, National High Magnetic Field Laboratory, Florida State University

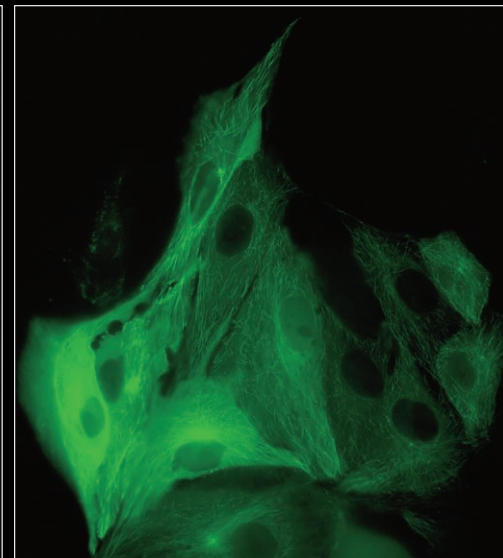
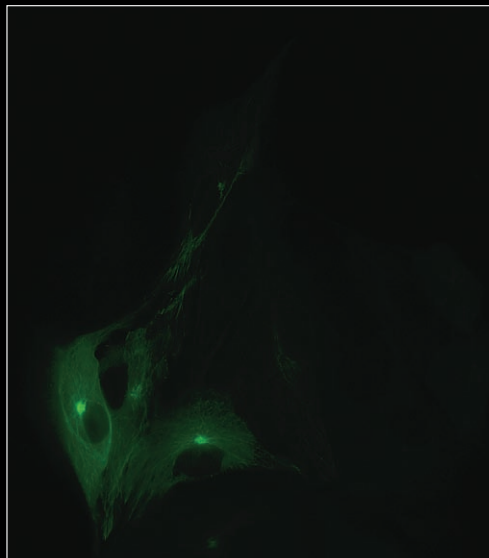

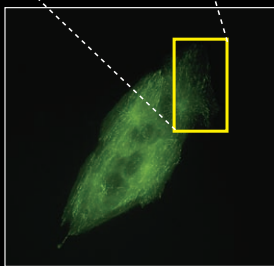
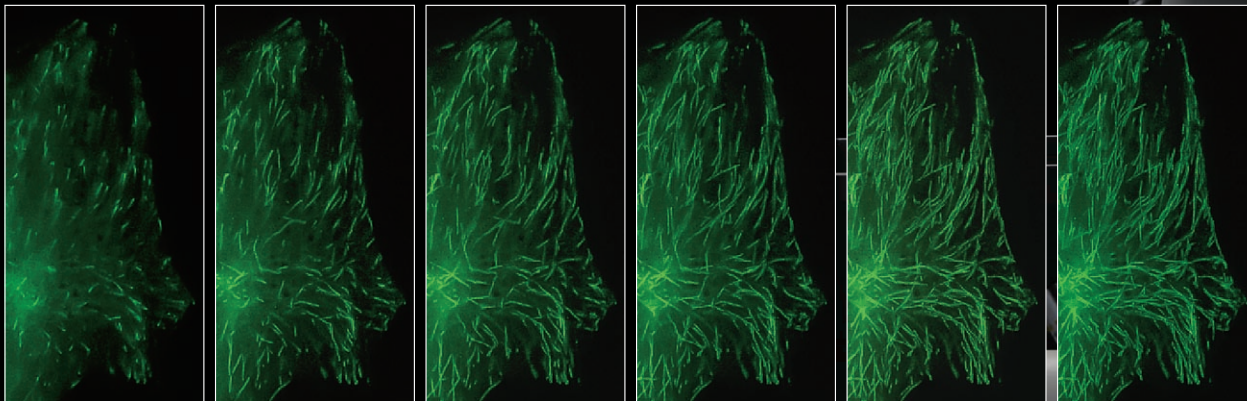

Time-lapse images (every 1 second) of LLC-PK1 cells with GFP-EB3 tubulin. Each image represents the maximum intensity projection of the timelapse, allowing visualization of the end-binding protein located on the microtubule plus-ends, and allowing tracing of the microtubule path.

DS-Qi2 captures an extremely large field of view, but still represents very fine details as demonstrated in this cropped timelapse sequence from a large FOV image. Objective: CFI Plan Apochromat λ 60x oil / NA: 1.4)

Sample courtesy of: Michael Davidson, National High Magnetic Field Laboratory, Florida State University



Time-lapse photography

Fluorescent time-lapse imaging through integration with NIS-Elements software

With a large field of view and pixel density, and low noise, the DS-Qi2 is ideal for time-resolved imaging applications.

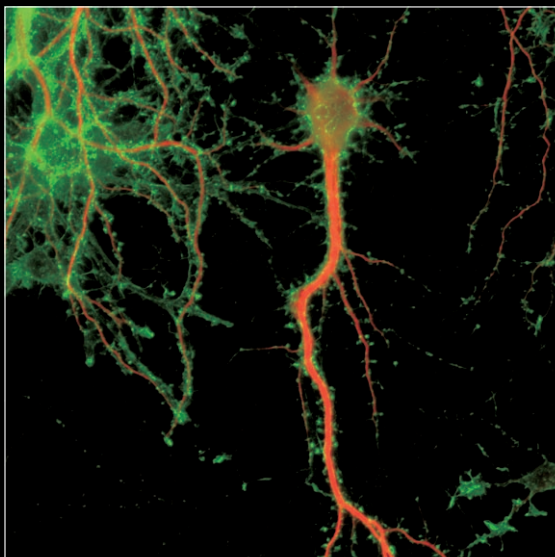

▲ Rat primary culture neuron
Dendron labeled with MAP-2(Red) and Actin(cytoskeleton) labeled with Phalloidin (Green)

▶ LLC-PK1 cells expressing GFP-EB3 tubulin (green) and H2B-labeled histones (red) illustrating the large field of view of the DS-Qi2 camera.

Sample courtesy of: Michael Davidson, National High Magnetic Field Laboratory, Florida State University

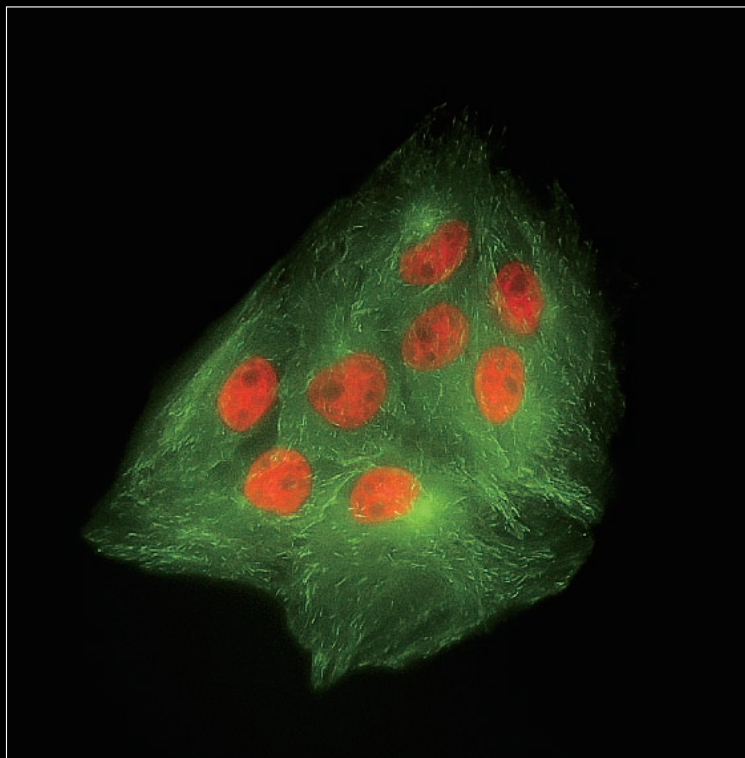

Integration with the comprehensive imaging software series

Nikon uses the NIS-Elements series as control software. NIS-Elements allows functions from basic imaging to control of the microscope and peripheral devices to be performed, as well as the measurement, analysis, and management of acquired images. Four basic packages and a variety of optional modules are available to suit every application and objective.

* See the NIS-Elements Catalog for details.

F Free package

The bundled free package offers functions for the display of scale on live images, full-screen display, and more. The simple operation screen makes shooting easy.

D Documentation package

The documentation package is equipped with measurement and report creation functions. It enables general microscopic image acquisition in fields from biomedical to industrial, and is expandable through optional added features such as EDF and databases.

Br Ar Research package

The research package enables the construction of advanced image acquisition systems, including multidimensional imaging (up to 4 dimensions for Br, 6 dimensions for Ar), through integration with systemized microscopes. Sets equipped with a rich range of image processing and analysis functions are available for every application.

Compatible OS: Windows® 7 Pro 32/64bit

* Nikon provides confirmed compatible PCs with up-to-date specifications. Contact Nikon for details.

Multichannel (multi color) **Ar Br**

NIS-Elements can acquire full bit depth multi-color images, combining multiple fluorescence wavelengths and different illumination methods (DIC, phase contrast etc.), while offering independently scalable channels.

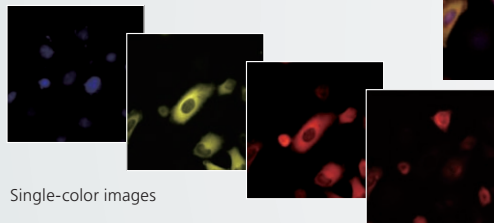
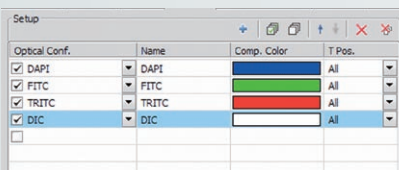

Single-color images

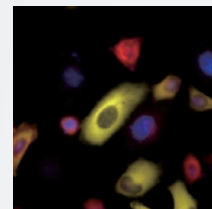

Specified-color merged image

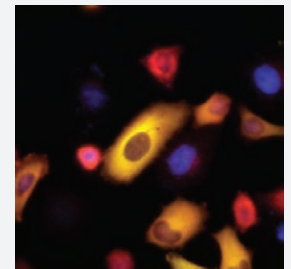

All-color merged image

Z-series **Ar Br D**

Through motorized focus control, NIS-Elements reconstructs and renders 3D images from multiple Z-axis planes.

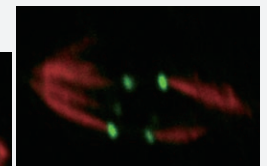
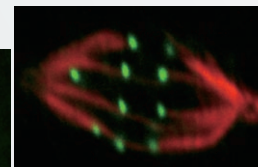
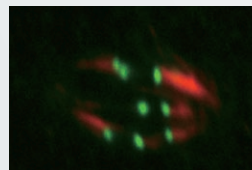
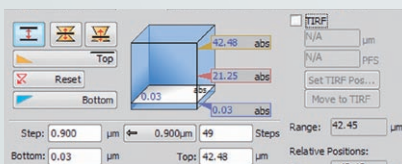

Multi-dimensional Image Display **Ar Br**

NIS-Elements displays time lapse, multi-channel, multiple X, Y, Z positions in an intuitive layout, which allows for automatic playback and the ability to select subsections of the data to be saved as a new file.

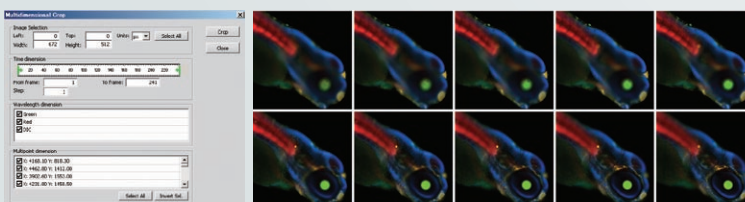

Time
 Multipoint
 Z-series
 Channel

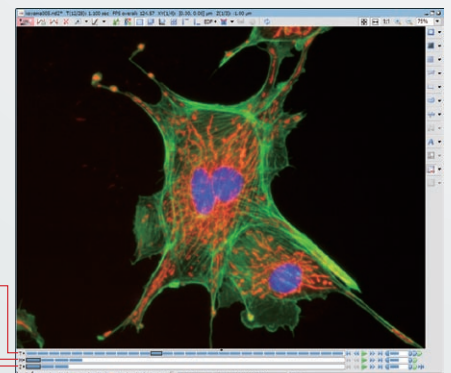

HDR (High Dynamic Range) image acquisition

Ar Option Br D

HDR creates an image with appropriate brightness in both the dark and bright regions in a sample by combining multiple images acquired with different exposure settings. It is also possible to create HDR image using multiple captured images.

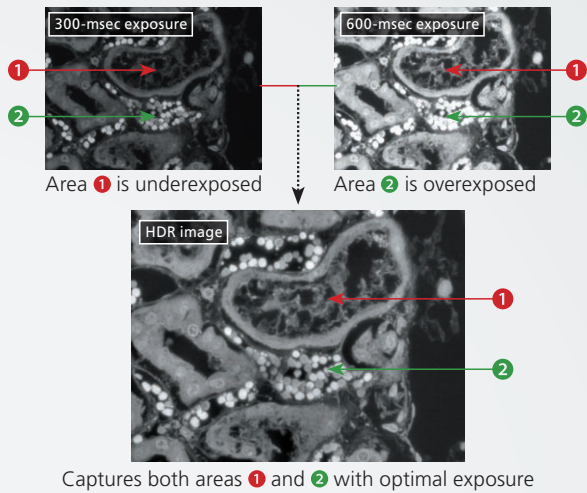

EDF (Extended Depth of Focus)

Option Ar Br D

Creates a single, all-in-focus image from images of differing focus. Such images can now be created by simply turning the focus knob.

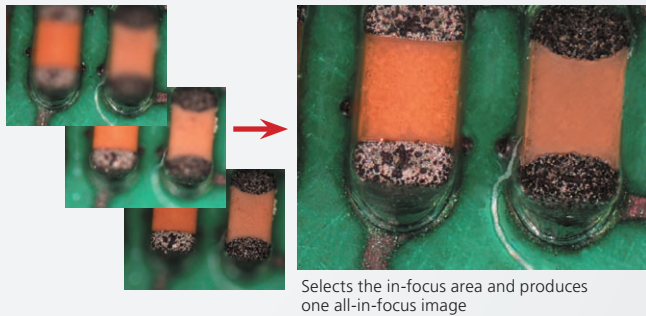
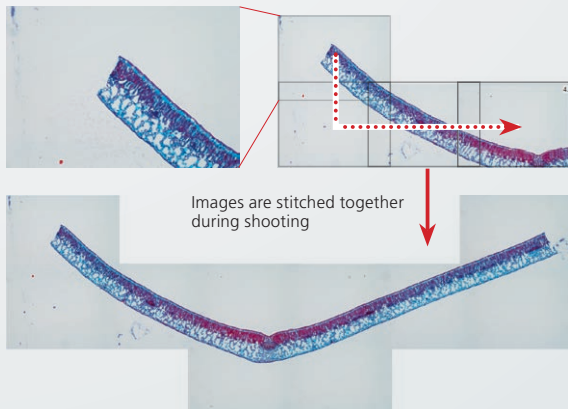

Image stitching (Large Image)

Option Ar Br D

Stitches together images from multiple fields of view during shooting to create an image with wide field of view. Images already acquired can also be stitched together.



Manual measurement and image annotation

Ar Br D

Manual Measurement allows easy measurement of length and area by drawing lines or an object directly on the image. The results can be attached to the image, and also exported as text or to an Excel spreadsheet.

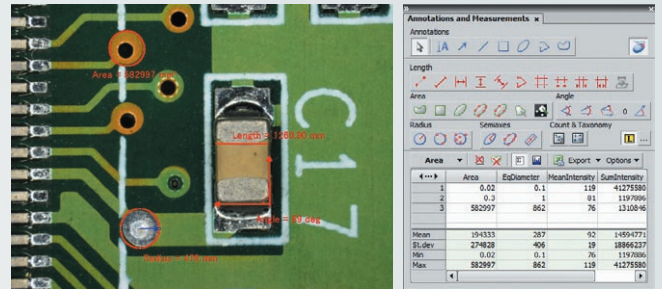

Auto measurement (Object Counting)

Ar Br Option D

Performs binarization on images using previously set thresholds to measure the number, area, brightness, etc. of identified objects.

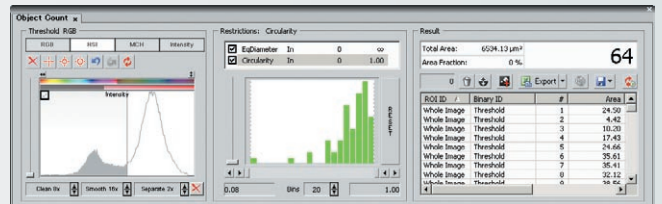
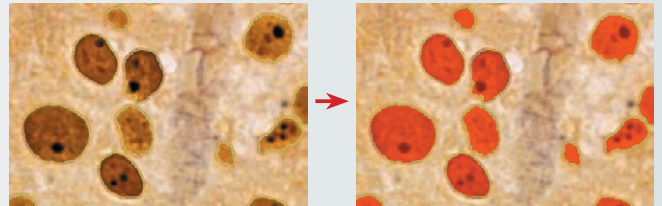

Grain size analysis

Option Ar Br D

Detects and measures grains in one and two phase samples according to JIS G0551 or ASTM E112-96/E1382-97 standards.



Cast iron analysis

Option Ar Br D

Detects, measures and classifies graphite content as well as ferrite content in graphite-corrected samples according to JIS G5502 or ASTM A247-06 standards.

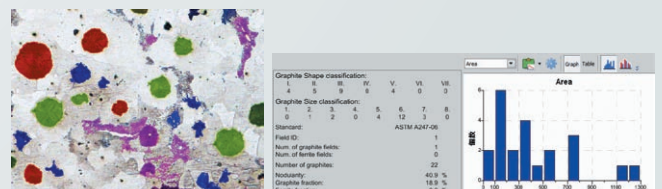

Dimensions

DS-Fi3

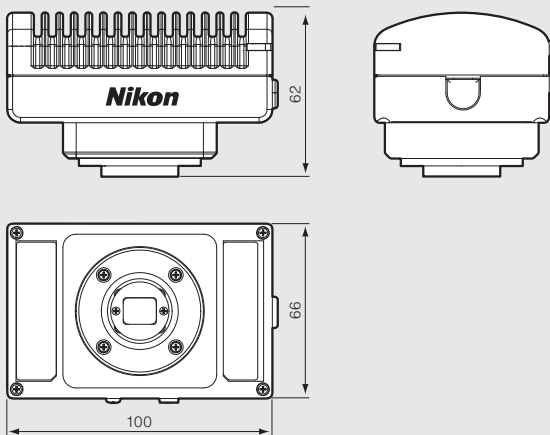

DS-Ri2 / DS-Qi2

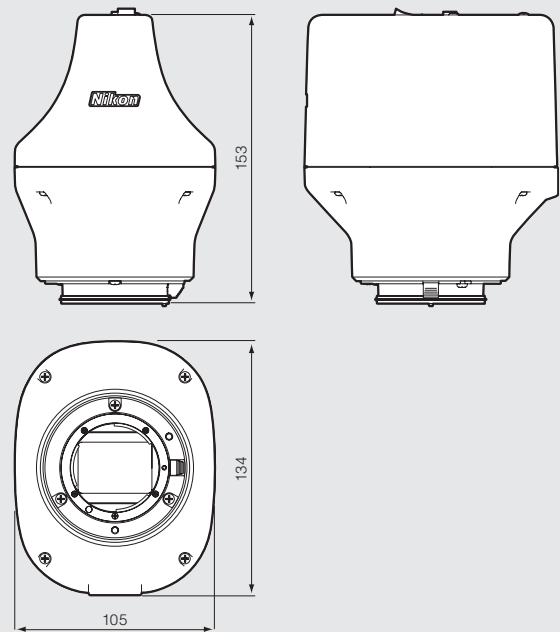

DS-L4

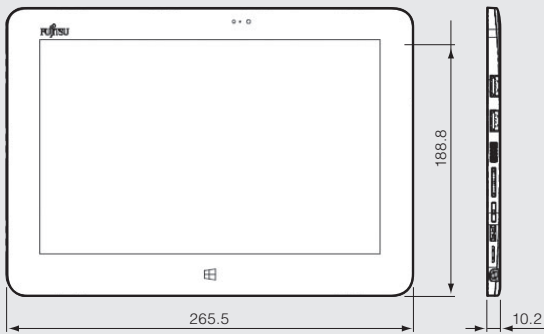

DS-L4 cradle AC adapter

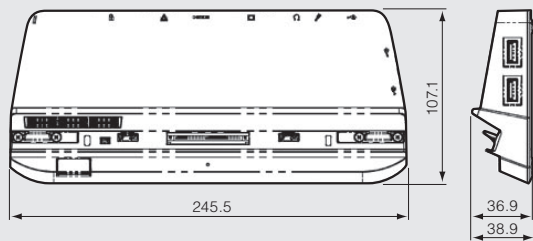

System Diagram

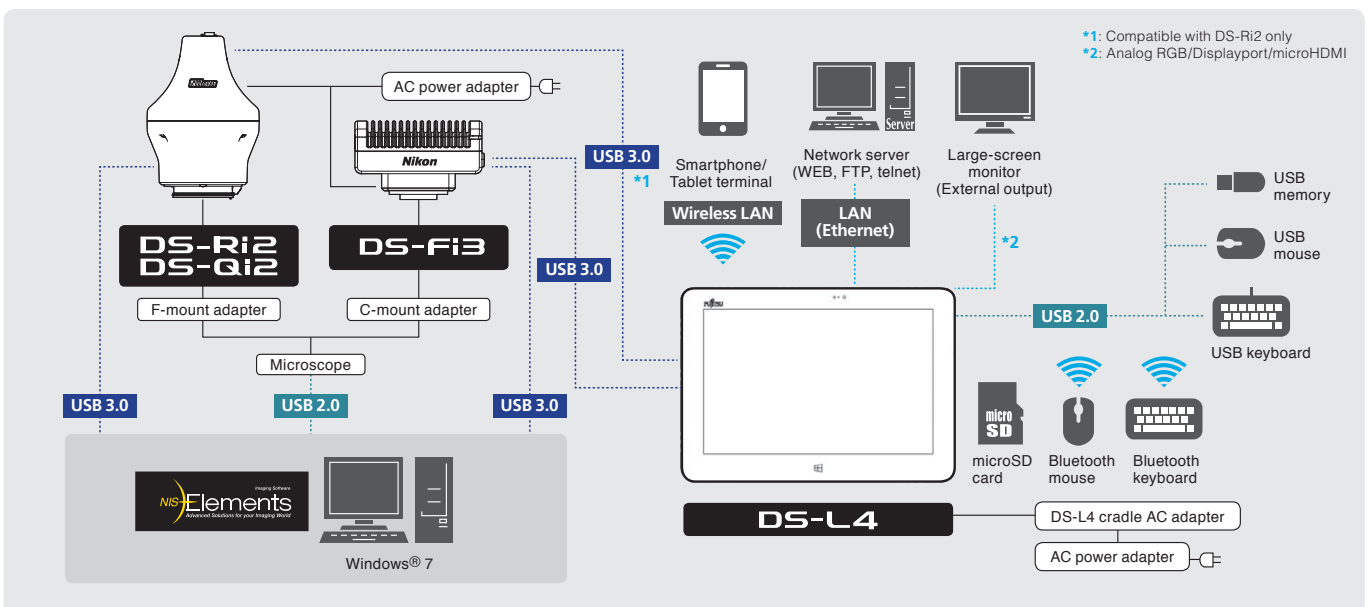

Specifications

Microscope Digital Camera

Model name	DS-Fi3	DS-Ri2	DS-Qi2
Image sensor	1/1.8 inch Color CMOS image sensor Size: 6.91 × 4.92 mm	Nikon FX-format Color CMOS image sensor Size: 36.0 × 23.9 mm	Nikon FX-format Monochrome CMOS image sensor Size: 36.0 × 23.9 mm
Recordable pixels	All pixels: 2880 × 2048 2 Vertical and 2 horizontal pixels average: 1440 × 1024	All pixels: 4908 × 3264 3 × 3 pixels average: 1636 × 1088	
Lens mount	C-mount	F-mount	
Cooling method		—	Electronic cooling
ISO sensitivity (recommended exposure index)	Standard: equivalent to ISO 50 (Selectable from ISO 50 to ISO 3200 equivalent)	Standard: equivalent to ISO 200 (Selectable from ISO 200 to ISO 12800 equivalent)	Standard: equivalent to ISO 800 (Selectable from ISO 800 to ISO 51200 equivalent)
Quantum efficiency		—	77%
Full well Capacity		—	60000e (- typ.)
Readout noise		—	2.2e (- typ.)
Dark current		—	0.6e-/p/s (Ta=25°C)(typ.)
Live display mode*1 (maximum fps)	All pixels (2880 × 2048): 15 fps 2 Vertical and 2 horizontal pixels average (1440 × 1024): 30 fps	All pixels (4908 × 3264): 6 fps 3 × 3 pixels average (1636 × 1088): 45 fps	
Exposure time	100 μsec ~ 30 sec	100 μsec ~ 120 sec	
Photometry mode	Average photometry: Average intensity within the photometry area Peak photometry: Maximum intensity within the photometry area		
Exposure control	One-time automatic exposure: Exposure time is adjusted automatically for one-time within the optimum range for the camera Continuous automatic exposure: Automatic exposure adjustment is performed continuously to keep the exposure within the camera Manual exposure: Exposure time and gain settings are made manually		
Exposure correction	±1EV Step:1/6EV		Average metering: -1 EV ~ +1/2 EV Peak hold metering: -1 EV ~ ±0 EV
Interface	USB3.0 (connect with PC, DS-L4) × 1, External trigger × 1		USB3.0 (connect with PC) × 1, External trigger × 1
Power supply	AC100-240V 50Hz/60Hz		
Power consumption	4.8 W	13W	24W
Dimensions	100(W) × 66(D) × 65(H)mm	105(W) × 134(D) × 153(H)mm	
Weight	400g (approx.)	1200g (approx.)	
Operating environment	0-40°C, 60% RH max. (without condensation)		0-30 °C, 80% RH max. 30-40°C, 60% RH max. (without condensation)

Microscope Camera Control Unit

Model name	DS-L4
Connectable cameras	DS-Fi3, DS-Ri2
Live image	FULL (resolution emphasized), FAST (display frame rate emphasized) Format: RGB 24bits
Exposure control	Program AE/ Focus AE/Manual AE With AE lock function
Brightness adjustment	Exposure mode AE: Exposure compensation adjustment, Exposure mode manual AE: Exposure time or gain adjustment
Exposure metering	Average metering, Peak hold metering
Exposure metering area	Position/size variable
White balance	One-push operation
Image correction	Tone, sharpness, black level, hue, chroma, R/B adjustment, shading correction, special effect
Scene mode	LED/halogen, Biological/industrial/asbestos/standard Custom: Up to 7 types can be registered
Recording format	Colorspace: sRGB Still image: Tiff/Jpeg/DICOM, movie: AVI
Saving destination	Internal drive (flash memory 64GB, approx. 28GB available) /microSD/USB memory/SMB file server
Measurement/drawing/scale	Measurement target: Point-to-point distance, perpendicular line length, angle, circle, distance, between center points of two circles, area Measurement unit calibration registration: Auto registration calibration by objective information setting (seven types registerable) Manual registration calibration: Manual calibration/Optical calibration by entering objective magnification (14types) Drawing: Text, line, arrow, pen, marker, scale bar Scale: Cross, grid line, X scale (cross scale), XY scale
Microscope control*2	Biological microscope: Ni-E/Ni-U/Ci-E/Ti2-E/Ti2-A Industrial microscope: LV150NA/LV100DA-U/LV100NDA Stereo microscope: SMZ25/SMZ18/SMZ1270i
Supported language	English, Japanese
Security	Anti-virus: McAfee Embedded Control is preinstalled. Programs that are started by the white list method are controlled. User login method: With DS-L4 user registration, login is possible by entering user ID and password
LCD display	10.1-inch wide TFT LCD display (1920×1200 WUXGA)
Interface	USB 3.0 host port ×1, USB 2.0 port ×4, DisplayPort, microHDMI, LAN (IEEE 802.3 10/100/1000Base-TX, IEEE 802.11 a/b/g/n), Bluetooth, microSD card slot
Power supply	AC100-240V 50Hz/60Hz
Power consumption	65W
Dimensions	Main body: 265 × 188 × 10 mm, Including extended cradle: 265 × 201 × 107 mm
Weight	Main body: 630g (approx.), Including extended cradle: 1060g (approx.)
Operating environment	5-35°C, 20-80% RH max. (without condensation)

*1: Maximum frame rate depends on exposure time.

*2: Please contact Nikon for details.

Specifications and equipment are subject to change without any notice or obligation on the part of the manufacturer. August 2017 ©2004-2017 NIKON CORPORATION
Microsoft and Windows are registered trademarks of Microsoft Corporation in the United States and other countries. Company and product names listed in this catalog are trademarks or registered trademarks of each company.

N.B. Export of the products* in this catalog is controlled under the Japanese Foreign Exchange and Foreign Trade Law.
Appropriate export procedures shall be required in case of export from Japan.

*Products: Hardware and its technical information (including software)



WARNING TO ENSURE CORRECT USAGE, READ THE CORRESPONDING MANUALS CAREFULLY BEFORE USING THE EQUIPMENT.



NIKON CORPORATION

Shinagawa Intercity Tower C, 2-15-3,
Konan, Minato-ku, Tokyo 108-6290, Japan
Healthcare Business Unit, phone: +81-3-6433-3705 fax: +81-3-6433-3785
Industrial Metrology Business Unit, phone: +81-3-6433-3703 fax: +81-3-6433-3784
<http://www.nikon.com/products/>

ISO 14001 Certified
for NIKON CORPORATION

NIKON INSTECH CO., LTD.

Shinagawa Intercity Tower C, 2-15-3, Konan, Minato-ku, Tokyo 108-6290
phone: +81-3-6433-3701 fax: +81-3-6433-3784

NIKON INSTRUMENTS INC.

1300 Walt Whitman Road, Melville, N.Y. 11747-3064, U.S.A.
phone: +1-631-547-8500; +1-800-52-NIKON (within the U.S.A. only)
fax: +1-631-547-0306

<http://www.nikoninstruments.com/>

NIKON METROLOGY, INC.

12701 Grand River Avenue, Brighton, MI 48116 U.S.A.
phone: +1-810-220-4360 fax: +1-810-220-4300

E-mail: Sales.US.NM@nikon.com

<http://www.nikonmetrology.com/>

NIKON INSTRUMENTS EUROPE B.V.

Tripolis 100, Burgenweeshuispad 101, 1076 ER Amsterdam, The Netherlands
phone: +31-20-7099-000 fax: +31-20-7099-298

<http://www.nikoninstruments.eu/>

NIKON METROLOGY EUROPE NV

Geldenaaksebaan 329, 3001 Leuven, Belgium
phone: +32-16-74-01-00 fax: +32-16-74-01-03

E-mail: Sales.Europe.NM@nikon.com

<http://www.nikonmetrology.com/>

NIKON INSTRUMENTS (SHANGHAI) CO., LTD.

CHINA phone: +86-21-6841-2050 fax: +86-21-6841-2060
(Beijing branch) phone: +86-10-5831-2028 fax: +86-10-5831-2026
(Guangzhou branch) phone: +86-20-3882-0550 fax: +86-20-3882-0580

NIKON INSTRUMENTS KOREA CO., LTD.

KOREA phone: +82-2-2186-8400 fax: +82-2-555-4415

NIKON SINGAPORE PTE LTD.

SINGAPORE phone: +65-6559-3651 fax: +65-6559-3668

NIKON MALAYSIA SDN. BHD.

MALAYSIA phone: +60-3-7809-3688 fax: +60-3-7809-3633

PT. NIKON INDONESIA

INDONESIA phone: +62-21-574-6262 fax: +62-21-574-6363

Nikon Sales (Thailand) Co., Ltd.

THAILAND phone: +66-2633-5100 fax: +66-2633-5191

NIKON INDIA PRIVATE LIMITED

INDIA phone: +91-124-4688500 fax: +91-124-4688527

NIKON CANADA INC.

CANADA phone: +1-905-602-9676 fax: +1-905-602-9953

NIKON INSTRUMENTS S.p.A.

ITALY phone: +39-55-300-96-01 fax: +39-55-30-09-93

NIKON GMBH SWITZERLAND

SWITZERLAND phone: +41-43-277-28-67 fax: +41-43-277-28-61

NIKON CEE GMBH

AUSTRIA phone: +43-1-972-6111-00 fax: +43-1-972-6111-140

NIKON UK LTD.

UNITED KINGDOM phone: +44-208-247-1717 fax: +44-208-541-4584

NIKON METROLOGY UK LTD.

UNITED KINGDOM phone: +44-1332-811-349 fax: +44-1332-639-881

E-mail: Sales.UK.NM@nikon.com

NIKON FRANCE S.A.S.

FRANCE phone: +33-1-4516-45-16 fax: +33-1-4516-45-55

NIKON METROLOGY SARL

FRANCE phone: +33-1-60-86-09-76 fax: +33-1-60-86-57-35

E-mail: Sales.France.NM@nikon.com

NIKON GMBH

GERMANY phone: +49-211-941-42-20 fax: +49-211-941-43-22

NIKON METROLOGY GMBH

GERMANY phone: +49-6023-91733-0 fax: +49-6023-91733-229

E-mail: Sales.Germany.NM@nikon.com