

SHARP

MX-M502N/M452N MX-M362N/M282N

Digital Multifunctional System



Bring the Benefits of Sharp Document Solutions
to Your Office with This Colour Scan-Ready B/W MFD



COPY

NETWORK PRINT

NETWORK
COLOUR SCAN

SHARPEDESK

FAX
OPTION

Work Better— Try a Solid Solution by Sharp

When the document demands of your busy office call for more than just basic copier/printer functions, it's time to put the MX-M502N/M452N/M362N/M282N on your team.

Along with business-essential functions, this productive B/W MFD offers convenient full-colour network scanning, reliable data protection, and the workflow-enhancing solutions of Sharp OSA (Open Systems Architecture).

Fast output and an optional 100-sheet RSPF (reversing single pass feeder) ensure smooth B/W copy/print performance. There is no better way to boost office efficiency than colour network scanning, which enables the digitisation of paper-based documents for storage and distribution. It's as easy as making a copy!

Plenty of finishing options, Sharp's award winning multi-layered security, low energy consumption, and ease of use are all the more reason to make the switch to Sharp's MX-M502N/M452N/M362N/M282N.

Style, Function, and Ease of Use

The MX-M502N/M452N/M362N/M282N is an attractive, user-friendly addition to any workplace. Designed for easy navigation, the control panel features a 7.0-inch W-VGA touch-screen LCD that offers a choice of six screen colours and provides both thumbnail display and data file previews.





COPYING & NETWORK PRINTING

PRODUCTIVE

Super-Efficient Output

The MX-M502N/M452N/M362N/M282N delivers a fast output of **50/45/36/28 cpm/ppm***, enabling the production of large-volume documents that include memory-intensive graphics in less time. The first copy comes out in just **3.9/3.9/4.6/4.6 seconds** to save valuable time when performing multiple short-run jobs. What's more, the short, straight paper path minimises misfeeds, saving you paper and toner costs.

* A4, long-edge feeding

50 CPM PPM	45 CPM PPM	36 CPM PPM	28 CPM PPM
MX-M502N	MX-M452N	MX-M362N	MX-M282N

COPY
PRINT

Productive Collated Output from Memory

The MX-M502N/M452N/M362N/M282N's Scan Once/Print Many function only requires a single scan of a multi-page original for copying, and the RIP Once/Print Many function only needs to download print data once from the PC for printing. The machine then automatically saves the data into memory and outputs **collated** sets of copies or printouts in the proper page order (electronic sorting), with each set **offset stacked** for easier retrieval.



Multi-page original is scanned... (or print data sent from PC) stored on hard disk in proper page order... and stacked offset

COPY
PRINT

Automatic Document Feeding

An optional **RSPF** (reversing single pass feeder) efficiently feeds in up to **100 pages** of either one- or two-sided originals at a scanning speed of 50 opm and 20 opm, respectively.



COPY
PRINT

Network Tandem Function

When two of these MFDs are connected to the same office network, you can use both simultaneously to double copying/printing output to up to **100/90/72/56 cpm/ppm**. Large-volume jobs can be completed with ease, enabling you to meet tight deadlines.

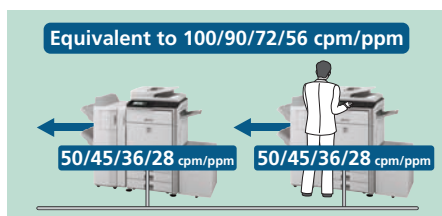

COPY
PRINT

Advanced Finishing

The MX-M502N/M452N/M362N/M282N makes it easy to create professional-looking booklets. The **Saddle Stitch Finisher** option staples documents up to 50 sheets and can fold and staple sets of documents up to 15 sheets to make completed booklets. It also features a **bi-folding** function that folds individual pages, up to size A3, in half—eliminating the tedious task of folding pages by hand. A space-efficient **Finisher** is also available for jobs that require simple sorting and stapling, while another option, a **4,000-sheet Finisher**, speeds through large projects to give you complete control over deadlines. Plus, an optional **Punch Module** allows you to punch holes in documents for easy filing.



A Variety of Job Finishing Options



Saddle stitching



Stapling



Hole punching



COPY
PRINT

Large Paper Capacity

For high-volume work, the MX-M502N/M452N/M362N/M282N can accommodate an optional 3,500-sheet large-capacity tray and stand with 2 x 500-sheet paper drawers for a total capacity of **5,600 sheets**. When a tray runs

out of paper, the **Auto Tray Switching** function automatically switches to another paper tray filled with the same size paper, allowing you to do extra-large volume jobs without worry.



COPY
PRINT

Job Build for Large-Volume Scanning

The MX-M502N/M452N/M362N/M282N easily handles large-volume copy jobs exceeding the optional RSPF's 100-sheet*1 capacity. For example, a 270-sheet original can be scanned as batches of 100 + 100 + 70 sheets and automatically stored on the MX-M502N/M452N/M362N/M282N's hard disk*2. Users can then print the entire document in a single run.

*1: A4, 80 g/m²

*2: The number of pages that can be stored for the Job Build function depends on the machine's HDD capacity and other conditions.

COPY
PRINT

Built-in Stackless Duplex Module

The MX-M502N/M452N/M362N/M282N can make **two-sided copies and printouts** using its built-in stackless duplex module, effectively reducing paper costs as well as saving filing space. Duplex copying is even more effective when used together with the RSPF.

COPY
PRINT

NETWORK-READY

Supports Most Office Environments

PRINT

- The MX-M502N/M452N/M362N/M282N works as a network printer with the latest and most commonly used operating systems and network protocols, including **IPv6**, and even in mixed OS environments. You get fast, powerful network printing via the 1000Base-T **Gigabit Ethernet** standard.
- The MX-M502N/M452N/M362N/M282N supports the **PCL6** printer language. For compatibility with **PostScript 3**, the MX-PKX1 PS3 Expansion Kit is available.

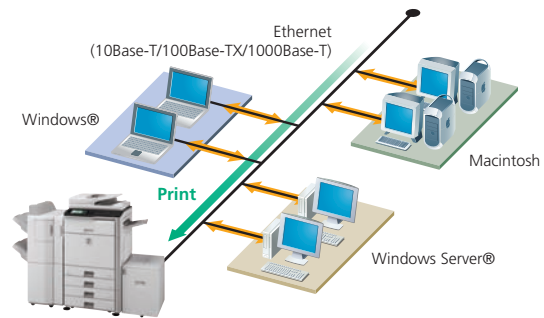

VERSATILE

USB Memory Direct Print

PRINT

One of the two USB ports on the MX-M502N/M452N/M362N/M282N is located at the front of the MFD beneath the control panel. It comes in handy when printing data directly from USB memory devices—an indispensable function for users who are in a hurry or who want quick machine access without a PC.



Versatile Paper Handling

COPY PRINT

The MX-M502N/M452N/M362N/M282N accommodates a wide range of paper sizes, from A5R to A3W. When using an optional finisher or exit tray, you can do A3 **full-bleed printing** onto **A3-wide** paper. Thanks to its tandem printing method, the MX-M502N/M452N/M362N/M282N can handle heavy paper stock up to **209 g/m²**, overhead transparencies, and other types of paper, further expanding the range of printing applications.

Image Editing Functions

COPY

The MX-M502N/M452N/M362N/M282N includes various editing functions made possible by digital technology.

- **Multi-Page Enlargement** divides an image onto separate sheets for making posters up to A0 x 2 in size.
 - **Photo Repeat** places multiple copies of an image onto a single sheet.
 - **Mirror Image** makes a reverse image of the original.
 - **XY Zoom** adjusts the horizontal and vertical ratios independently.
 - **B/W Reverse** reverses the black and white of an image.
- Please see specifications for a list of available convenient functions.

Optimum Copy Quality

COPY

600 x 600-dpi resolution and 256-level greyscale ensure finely detailed reproduction, while **Digital Auto Exposure Control** provides optimum copy contrast. For best results, there are seven exposure modes to choose from. Users can, for example, select Text mode for text-only originals or Photo mode for detailed, high-quality reproduction of photos and delicate halftone images.

Various Copy/Print Applications

COPY PRINT

Copy & Print

- **Tab Copy/Print** can copy or print directly onto tabs on document separators and insert them into assigned positions.
- **Multi-Shot** copying and **N-up** printing
- **Pamphlet Style** copying/printing
- **Cover/transparency** insertion

Print

- **Direct Print***1 allows **PDF***2, **TIFF**, **JPEG**, or **XPS***3 files to be printed without using the printer driver or opening applications.
 - *1: Direct printing may not support all PDF, TIFF, JPEG, and XPS formats.
 - *2: Direct PDF printing requires optional MX-PKX1.
 - *3: Direct XPS printing requires optional MX-PUX1 and MX-ARSMX3.
- **Carbon Copy Print** mode automatically outputs multiple printouts of the same data on plain and/or coloured paper; convenient for invoices and purchase orders.
- **Form Overlay** can store office document formatting such as letterheads and overlay contents, eliminating the need for pre-printed paper.
- **Barcode font** compatibility (with optional AR-PF1 Barcode Font Kit)

Copy

- **Book Copy** is convenient for compiling copies of a book or bound originals into pamphlet format.
 - **Card Shot** enables one-touch copying of both sides of a card (credit cards, ID cards, etc.) onto a single page.
 - **Mixed Size Original Copy** mode automatically distinguishes documents of mixed sizes* (such as A3/B4, B4/A4, etc.) fed through the optional RSPF and chooses the appropriate paper.
- * Some restrictions apply when combining paper sizes of different format series.

IMAGE SENDING

A3 Colour Network Scanning

SCAN

The MX-M502N/M452N/M362N/M282N works as a **full-colour network scanner**. Converting any type of paper-based document, up to A3 in size, into an editable digital file is as easy as making a copy. The MX-M502N/M452N/M362N/M282N supports TIFF, PDF, encrypted PDF, compact PDF*, JPEG, and XPS (XML Paper Specification) file formats.

* Requires optional MX-EBX3.

Multiple Distribution of Scanned Files

SCAN FAX

With the touch of a few buttons, you can choose different ways to distribute your scanned documents. **Scan to E-mail** sends documents as an e-mail attachment. **Scan to FTP Server** scans documents directly to an FTP server for storage. **Scan to Desktop** sends scanned documents directly to your PC desktop. **Scan to Network Folder (SMB)** sends files to a shared folder on a networked Windows PC. **Scan to USB Memory** scans documents directly to USB memory devices. **Scan to Fax** enables conventional faxing or Internet faxing.

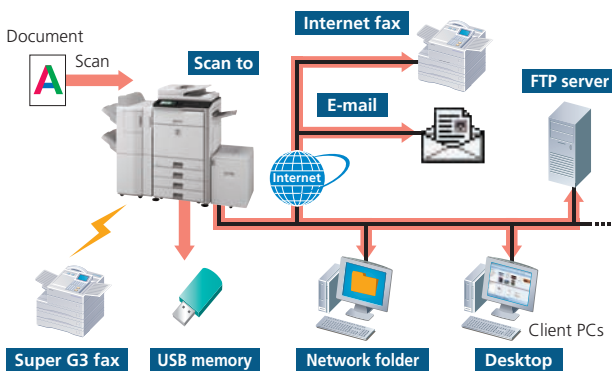

LDAP Support

SCAN FAX

Built-in LDAP (lightweight directory access protocol) support eliminates the need to enter or register full addresses. By entering the first few letters of the recipient's name, the MX-M502N/M452N/M362N/M282N displays a list of possible matches from your company's LDAP server. Selected addresses can be stored to the MX-M502N/M452N/M362N/M282N's address book.

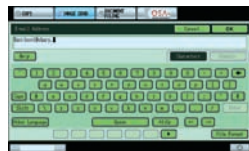

High-Speed Faxing

FAX

The optional MX-FXX2 Fax Expansion Kit turns the MX-M502N/M452N/M362N/M282N into a 33.6 Kbps **Super G3 fax**. Using JBIG compression technology, the MX-M502N/M452N/M362N/M282N can send an A4 size page in under 3 seconds*. Use the optional 100-sheet RSPF to further boost faxing efficiency. Additionally **Quick On-Line Transmission** can start dialling and transmitting as soon as the first page is scanned into memory, you can send documents in **less time**.

* Based on Sharp's standard chart with approximately 700 characters (A4 long-edge feeding) at standard resolution.

Automated Fax Finishing

FAX

The MX-M502N/M452N/M362N/M282N eliminates the need to copy and staple received faxes by hand. Simply use the Fax Output setting on the LCD control panel to designate the number of copies. With finishing options installed, the MX-M502N/M452N/M362N/M282N will even automatically staple these documents for you.

Output settings for received faxes



PC-Fax/PC-Internet Fax

FAX

Directly send a document created on your PC to a recipient's fax machine via a phone line or the Internet without printing to paper. Save time and paper costs while retaining original document quality.

Note: PC-Internet Fax requires optional MX-FWX1; PC-Fax requires MX-FXX2.

Internet Fax

FAX

Economically send and receive faxes to and from other ITU-T T-37-compliant Internet fax machines via the Internet. The MX-M502N/M452N/M362N/M282N supports **Direct SMTP**; outgoing Internet faxes do not go through your mail server, making transmission faster and cheaper.

Note: Requires optional MX-FWX1.

Paperless Faxing with Inbound Routing

FAX

Paperless faxing with inbound routing lets you check incoming faxes via e-mail before printing. It can also forward incoming faxes to an FTP server, a network folder (SMB), or a PC desktop. Files can be saved in either PDF or TIFF (single/multi).

Note: Requires optional MX-FXX2 or MX-FWX1.

Other Key Features

Scan & Fax

- **One-touch auto dial keys** register up to **1,000** numbers for frequently used destinations
- **Broadcast transmission** to up to 500 destinations
- **Programme keys** (up to 48 keys) are available to set up frequently used transmissions for instant recall
- **Easy text entry*** lets you enter addresses, file names, subject titles or messages from the LCD control panel
* Only addresses can be entered for faxing.
- **Mixed size original scanning** automatically distinguishes documents of mixed sizes fed through the RSPF

Fax

- **Duplex transmission/reception** sends and prints out two-sided documents
- **Flash memory backup** ensures documents remain safely backed up in memory, even in the event of a power failure
- **Rotation transmission/reception** rotates incoming and outgoing faxes to match the direction of the printing paper
- **Fax destination confirmation** allows users to reconfirm fax numbers before sending to prevent transmission errors



SECURITY

Powerful Multi-Layered Security

With multiple levels of network and data security to cover a wide range of security needs, Sharp's security solutions protect your business assets and bring peace of mind. The MX-M502N/M452N/M362N/M282N safeguards sensitive data with powerful, enhanced security functions that eliminate the worry of unauthorised use and guarantee greater protection for your confidential information.

Data Security Kit

Digital copier/printers or MFDs can retain hundreds of pages of confidential information from previous jobs on their hard disks or internal memory. To safeguard this information from unauthorised access, the optional **Data Security Kit** automatically **encrypts and erases** the data after each job is complete as well as data stored both on the hard disk and in the address book.

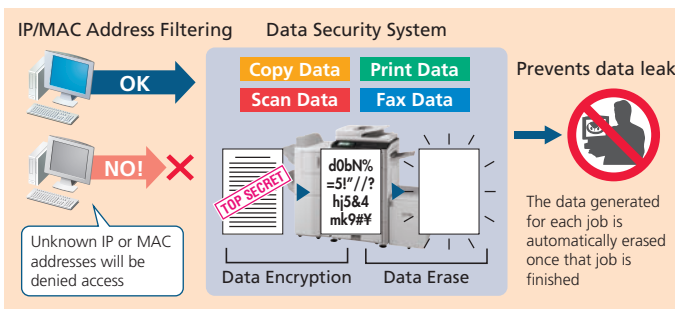

Secure Network Access

The MX-M502N/M452N/M362N/M282N's **IP/MAC address filtering** function provides highly secure operation by restricting access to these MFDs on your office network. Only PCs that have either their IP address or MAC (media access control) address registered are allowed to use the MX-M502N/M452N/M362N/M282N. Attempted access from an unknown IP or MAC address will be denied, preventing unauthorised use. These MFDs also support the **IEEE 802.1X** standard for port-based network access control, which blocks all access from unauthorised devices.

Encrypted PDF with Password Protection

To prevent unauthorised viewing of confidential image data, the MX-M502N/M452N/M362N/M282N enables users to password protect and encrypt PDF data. By setting a password when scanning, users can transmit a PDF over the network in encrypted format. Then, after transmission, viewers will only gain access to the encrypted PDF after successfully re-entering the chosen password.

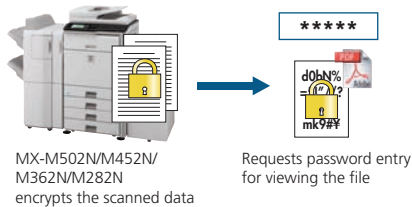

Secure Sockets Layer

SSL (secure sockets layer) enables the encryption of data communications to prevent data leakage through the network when printing via IPP, browsing secure Web pages (HTTPS), or communicating via e-mail (SMTP and POP3) or FTP (FTPS).

User Authentication

The MX-M502N/M452N/M362N/M282N prevents unauthorised use by requiring **passwords** for machine access. This safeguarded solution can register up to 1,000 users in **three access levels** as Administrator, User, or Guest and can designate to which function user authentication applies. The MX-M502N/M452N/M362N/M282N can, for example, be set to allow copying by all users while restricting colour scanning to designated users. The MX-M502N/M452N/M362N/M282N works with an **external Active Directory server** to extend user authentication to multiple MFDs and a greater number of users.



User authentication

Document Control Function

Document Control prevents unauthorised copying, scanning, faxing, and filing of confidential documents. This is how it works: the MX-M502N/M452N/M362N/M282N embeds copy prevention data onto a document when it is first copied or printed. It will then detect this data the next time someone tries to make a copy of the document. Any unauthorised attempts to copy a Document Controlled-document will simply be cancelled or result in the output of a blank page.

Note: Requires optional Data Security Kit. May not work for certain types of documents or paper.

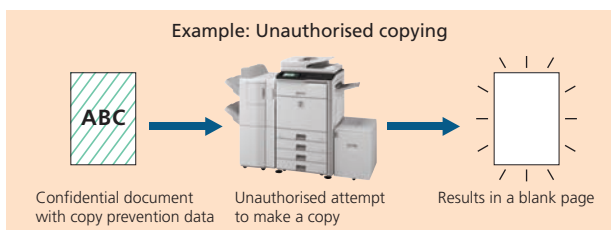

IPv6 and IPsec Support

The MX-M502N/M452N/M362N/M282N supports **IPv6**, the next-generation Internet protocol. An obligatory part of IPv6 is **IPsec** (IP Security), a set of protocols for securing Internet protocol (IP) communications. IPsec encrypts and authenticates traffic between specified parties, giving IPsec-compatible products an extremely high level of network security.

Scan to Me Function

By automatically sending scanned documents to the e-mail address of the authorised user currently logged in, the Scan to Me function prevents documents from being sent to the wrong address.

DOCUMENT MANAGEMENT

Document Management on the Hard Disk

You can save processed job data in designated folders on the MX-M502N/M452N/M362N/M282N's built-in hard disk, making it easy to instantly recall saved documents or jobs for printing and sending at a later time. This contributes greatly to efficient sharing and distribution of information in your business operations.

Easy Access to Stored Files

Documents stored on the hard disk can be quickly and easily searched and accessed from the control panel's LCD via thumbnail displays and file previews or through a Web browser.

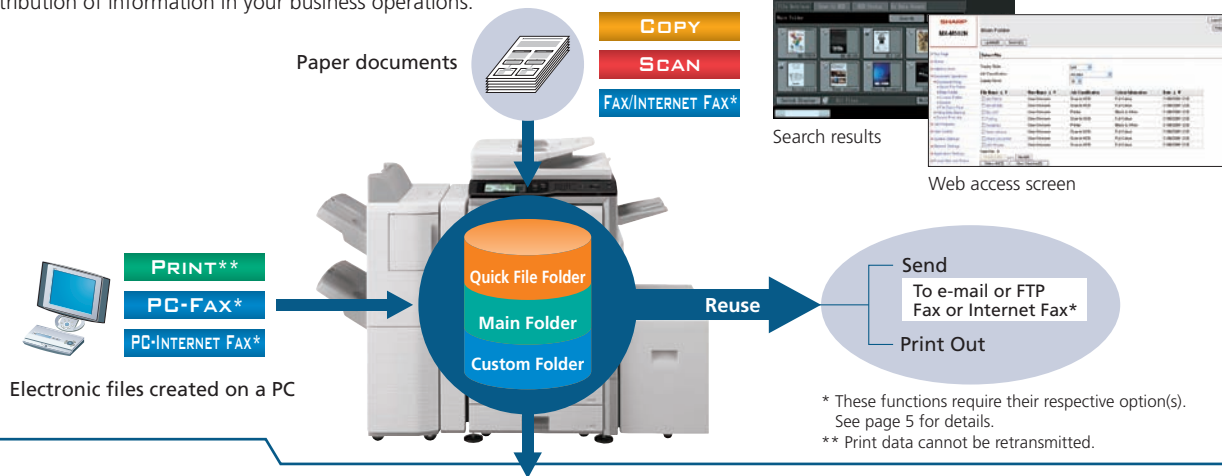

Quick Filing

Up to **10,000 pages** or 1,000 files*¹ that have been copied, printed, scanned, or faxed*² can be stored by job on the hard disk in a Quick File Folder. You can easily reuse saved data without having to reload or rescan the original.

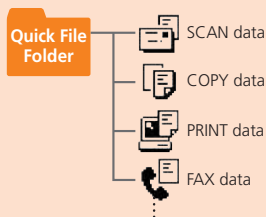

Advanced Filing Function

Up to **20,000 pages** or 3,000 files*¹ that have been copied, printed, scanned, or faxed*² can be stored by job on the hard disk in up to 1,000 folders with customised names and locations. Enhanced security features require users to enter a 5- to 8-digit password to access secure folders, protecting your sensitive data. Storage options include:

- **Main Folder** – You can store processed files by user name in the main public folder and share them across the workgroup. Any file name and a PIN code can be assigned to each saved job.
- **Custom Folder** - Up to 1,000 private folders (named as desired) can be created within the Custom Folder. When saving a file in a private folder, any file name can be assigned. A PIN code can be applied to both private folders and files.

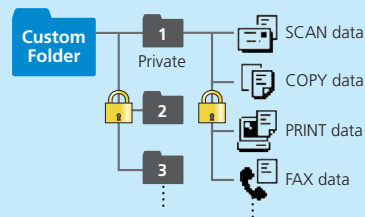
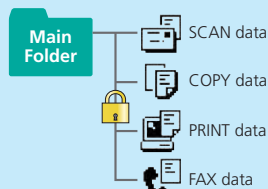

*1: Measured using Sharp's standard chart (A4 with 6% coverage, B/W). The Quick File Folder shares the HDD with the Job Build function; up to 12GB of data storage is available when using both functions. The storage capacity will be less for colour pages.

*2: For fax and Internet fax jobs, only transmitted data (not received faxes) can be saved in the Document Filing function.

Sharpdesk for Total Document Management

Sharpdesk is an original Sharp application that provides integrated desktop management of documents in over **200 file formats**, including scanned paper-based documents and those created with popular applications such as Word. It allows you to organise, edit, search, and distribute your documents, all with simple drag-and-drop operation.

- Intuitive desktop display features **thumbnail** viewing
- Sharpdesk Imaging provides **annotation** tools for paper-free proofreading
- Sharpdesk **Composer** combines different types of files into a single document
- **Optical character recognition** converts documents into editable text files
- **Output zone** distributes files to e-mail, printers, and other applications
- **File search** allows searching by file name, keyword, or thumbnail

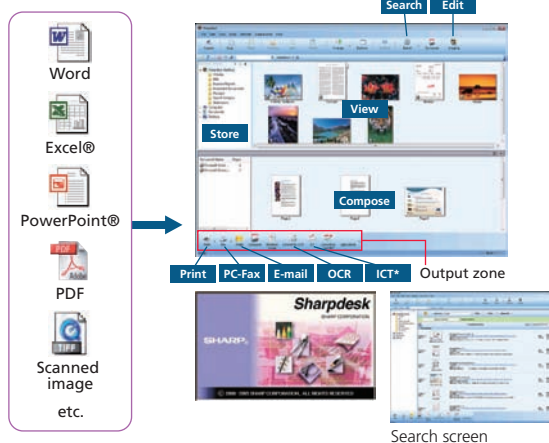

* Image Compression Tool for converting images into compact PDF files

DEVICE MANAGEMENT

Integrated Device Management

The MX-M502N/M452N/M362N/M282N allows for easy programming of complex settings and makes it possible for a system administrator to manage multiple devices from a single location. The result is minimum time and effort and maximum work efficiency.

Web-Based System Settings

Administrators can configure system settings such as address book control, document filing management, and user control (accounting) from either over the network or from the control panel of the MX-M502N/M452N/M362N/M282N.



Web-based device management

User Control

The MX-M502N/M452N/M362N/M282N has capabilities to **restrict machine access and usage**. Easily manage overall running costs by setting access rules through a Web browser to limit or restrict functions, such as the printing out or copying of large-volume documents.

- Authority Groups – Use of each function can be restricted individually.
- User control and account – Up to 1,000 password-protected user accounts can be created for customised access. Accounts can be set up for individuals, groups or departments, in conjunction with the authority group setting. Maximum limits for printing or copying pages can be set for each account.

Remote Diagnosis

The MX-M502N/M452N/M362N/M282N can be monitored remotely through a Web browser. In the event of a problem, such as a low amount of toner, an alert is displayed on the Web page. Additionally, the E-Mail Status and Alert function generates e-mail messages to notify the administrator when action or maintenance is required.

Printer Status Monitor

If the MX-M502N/M452N/M362N/M282N is low on paper or toner, the **Printer Status Monitor** will alert you in the form of easy-to-understand graphics, allowing you to avoid problems before they arise.



Printer Status Monitor

Device Cloning

Machine settings can be copied conveniently to another MX-M502N/M452N/M362N/M282N via a Web browser in XML format, making it easy to clone machines in a networked environment. With Device Cloning, the administrator no longer needs to set up individual machines one by one, thereby making his/her job a lot easier.

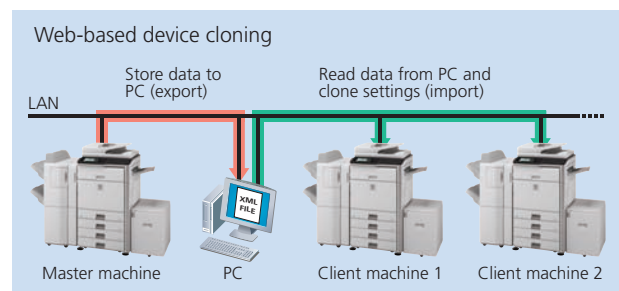

Remote Operation

With the MX-M502N/M452N/M362N/M282N's Remote Operation function, the same control panel screen found on the MFD can be displayed on the screen of a remote, office-networked PC, allowing the MFD to be operated via that PC*. This function can, for example, enable the administrator to guide an MFD user in need of help through necessary procedures. It also allows users, regardless of experience, to operate the MFD remotely, via the PC.

* Requires VNC application.

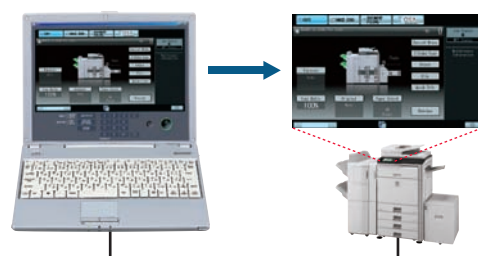

ENVIRONMENT & USER-FRIENDLY

ENVIRONMENTALLY ADVANCED

Environment Friendly

- With a standby power consumption of less than **1W** in night-time fax reception mode, the MX-M502N/M452N/M362N/M282N is one of the leaders in the industry in energy savings for MFDs.
- The MX-M502N/M452N/M362N/M282N conforms to standards set for the Nordic Swan European environmental label.
- In **support of the RoHS directive**, the MX-M502N/M452N/M362N/M282N are fully compliant by restricting the use of hazardous substances in their parts and materials.

- Conforming to the **ENERGY STAR®** programme, an international system identifying energy-efficient products, the MX-M502N/M452N/M362N/M282N has two levels of **energy-saving modes** to reduce or shut off electricity after a period of inactivity. Also, pressing the **power save key** after a job is finished immediately puts the MX-M502N/M452N/M362N/M282N into auto power saving mode for further cutbacks on running costs.



Power save key

EASY OPERATION

7.0-Inch Touch-Screen LCD

The MX-M502N/M452N/M362N/M282N's logically designed control panel features a wide, clear, W-VGA-resolution touch-screen LCD with easy-to-follow guidance. For example, when adjusting staple/sort finishing or making pamphlets, the LCD displays step-by-step instructions to guide you through the necessary procedures. Pushing the **Home** button, even in the middle of an operation, takes you back to the Start screen. Moreover you can quickly access the most frequently used functions and settings by programming them into **My Menu**.



Home screen



Staple/sort finishing

Sharp OSA (Open Systems Architecture)

The MX-M502N/M452N/M362N/M282N supports the Sharp OSA* development platform. This innovative technology allows users to interact with critical business and network applications and/or external account software right from the LCD control panel, offering a new realm of control and convenience. Since Sharp OSA utilises industry-standard network protocols, such as XML and SOAP, the MX-M502N/M452N/M362N/M282N can easily integrate with document management systems, enterprise resource planning software, workflow applications, and more.

* Requires optional MX-AMX2 and/or MX-AMX3.



Note: The screen shown above is just a sample. Screen layouts and user interfaces can be specifically designed to accommodate customised application programmes.



Thumbnail Display and Previews

Making the search for files easier and more convenient than ever, thumbnails and up-close previews of Document Filing data files, as well as conventional file names, can be displayed on the MX-M502N/M452N/M362N/M282N's LCD control panel. To help users decide which documents to print out, the LCD can also display thumbnails and previews of incoming faxes and Internet faxes. The MX-M502N/M452N/M362N/M282N even prevents errors in copying, scanning, or saving documents to its hard disk by showing previews of those jobs on the LCD before actually executing them, making it easy to confirm finishing options, scan settings, and other such items.



Thumbnails



Preview



Saddle stitching (preview)



2-in-1 copying (preview)

Job Status Screen

Whether printing or copying, the control panel displays a list of all jobs, showing you at a glance the jobs in progress and the position of your job in the queue. With a few quick touches of the LCD screen, the **Priority Printing** function lets you easily **change the job queue order** or delete jobs that are no longer needed.



Job status

OPTIONS

System Configuration

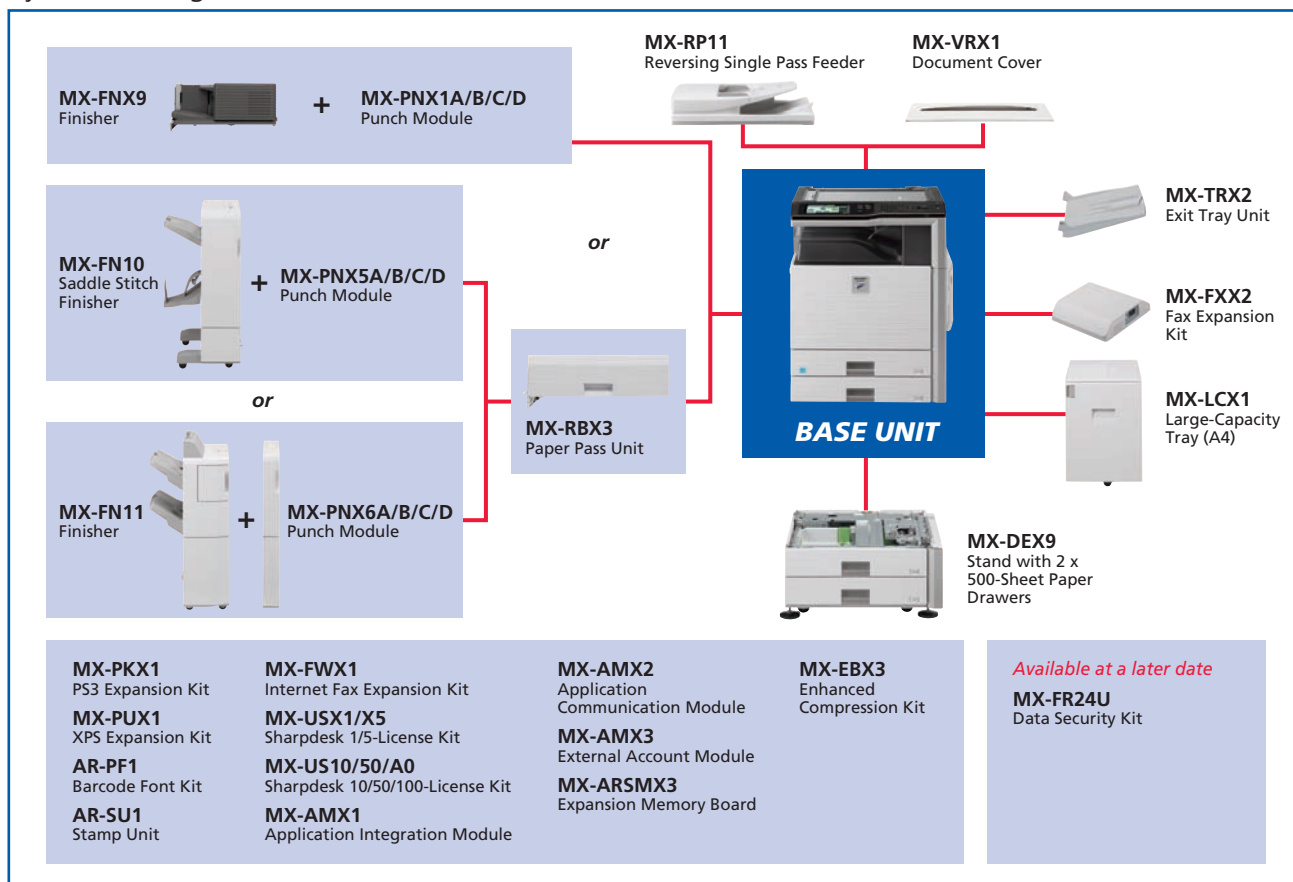

Certain options may not be available in some areas.

Specifications for Options

MX-FNX9 Finisher

Paper size	Non offset Offset/staple	A3W to A5R A3 to B5
Max. paper capacity (80 g/m ²)		500 sheets (A4 or smaller), 250 sheets (B4 or larger)
Max. stapling capacity (80 g/m ²)		50 sheets (A4 or smaller), 30 sheets (B4 or larger)
Staple position		3 locations (front, rear, or both)

MX-FN10 Saddle Stitch Finisher

Paper size	Non offset Offset/staple	A3W to A5R A3 to B5R
Max. paper capacity (80 g/m ²)	Offset tray	1,000 sheets (A4 or smaller, except A5R), 500 sheets (A5R, B4 or larger)
	Saddle stitch tray	10 sets of 11–15 sheets, 15 sets of 6–10 sheets, 20 sets of 1–5 sheets
	Stapling capacity	50 sheets (A4 or smaller), 25 sheets (B4 or larger)
Staple position		3 locations (front, rear, or both)

MX-FN11 Finisher

Paper size	Non offset Offset/staple	A3W to A5R A3 to B5
Max. paper capacity (80 g/m ²)	Upper tray	1,550 sheets (A4)
	Lower tray	2,450 sheets (A4)
Max. stapling capacity (80 g/m ²)		50 sheets (A4 or smaller), 30 sheets (A4R, B4 or larger)
Staple position		3 locations (front, rear, or both)

Punch Modules

Model name	For the MX-FNX9	MX-PNX1A	MX-PNX1B	MX-PNX1C	MX-PNX1D
	For the MX-FN10	MX-PNX5A	MX-PNX5B	MX-PNX5C	MX-PNX5D
	For the MX-FN11	MX-PNX6A	MX-PNX6B	MX-PNX6C	MX-PNX6D
Number of holes		2	3	4	4 (wide)
Paper weight		56 to 209 g/m ² *			

* Guaranteed punchable weight is 56 to 128 g/m².

MX-DEX9 Stand with 2 x 500-Sheet Paper Drawers

Paper size (upper and lower tray)	A3 to B5R
Paper capacity (upper and lower tray)	500 sheets each (80 g/m ²)

MX-LCX1 Large-Capacity Tray

Paper size	A4, B5
Paper capacity	3,500 sheets (80 g/m ²)

MX-FXX2 Fax Expansion Kit

Compression method	MH/MR/MMR/JBIG
Communication protocol	Super G3/G3
Modem speed	33,600 bps to 2,400 bps

Sharpdesk 3.3 System Requirements

Supported OS	Windows® XP (SP2) Professional/Home Edition, Windows Vista®, Windows 7
Hard disk	Minimum requirement of operating system used plus at least 500MB to store Sharpdesk and Network Scanner Tool programmes
CPU	Pentium® or equivalent processor (Windows XP: 800 MHz 32-bit/64-bit processor; Windows Vista and Windows 7: 1 GHz 32-bit/64-bit processor)
Memory	Windows XP: 512MB RAM; Windows Vista and Windows 7: 1GB RAM/2GB RAM (Windows 7 64-bit)
Monitor	Windows XP: SVGA display; Windows Vista and Windows 7: Direct X9 support with 128MB video RAM

SPECIFICATIONS

General

Type	Desktop
Engine speed	Max. 50/45/36/28 cpm/ppm (A4, long-edge feeding)
Paper size	Max. A3W, min. A5R
Paper capacity (80 g/m ²)	Standard: 1,100 sheets (two 500-sheet trays and 100-sheet multi-bypass tray) Maximum: 5,600 sheets
Paper weight	Tray: 60 g/m ² to 209 g/m ² Large-capacity tray: 60 g/m ² to 105 g/m ² Multi-bypass tray: 56 g/m ² to 209 g/m ²
Warm-up time*1	Less than 20 sec.
Memory	Copier memory: 576MB Printer memory: Standard 1GB, max. 2GB 80GB HDD*2
Power requirements	230-240V AC, 50/60 Hz
Power consumption (max.)	1.84 kW
Dimensions (W x D x H)	645 x 695 x 833 mm *3
Weight (approx.)	88 kg*3
Features	Job build, document filing, user authentication (1,000 accounts), toner save mode, pre-heat/auto power shut-off modes, preview, thumbnail view*4

Copier

Original paper size	Max. A3
First copy time*5	3.9/3.9/4.6/4.6 sec.
Continuous copy	Max. 999 copies
Resolution	Scan: 600 x 600 dpi, 600 x 400 dpi, 600 x 300 dpi Print: 600 x 600 dpi
Gradation	Scan: 256 levels Print: 2 levels
Zoom range	25 to 400% (25 to 200% using RSPF) in 1% increments
Preset copy ratios	10 ratios (5R/5E)
Features	Auto paper selection (mixed/random size feeding), auto magnification selection, paper type selection, auto tray switching, rotation copy, electronic sorting, network tandem copy, book copy, margin shift, dual page copy, multi-shot (4-in-1, 2-in-1), cover/transparency/tab page insertion, 2-sided copy orientation change, XY zoom, B/W reverse, mirror image, duplex copy, job reservation, job programme, photo repeat, irregular original/paper size input, stamps (date, page number, text, stamp), multi-page enlargement, tab copy, centering, proof copy, watermarks, sharpness, card shot, edge/centre erase, pamphlet copy, original count

Network Colour Scanner

Scan method	Push scan (via control panel), pull scan (TWAIN-compliant application)
Resolution	Push scan: 100, 200, 300, 400, 600 dpi Pull scan: 75, 100, 150, 200, 300, 400, 600 dpi 50 to 9,600 dpi via user setting
File formats	TIFF, PDF, encrypted PDF, JPEG (colour only), XPS*6, compact PDF*7
Scanner utility	Sharpdesk
Scan destinations	Scan to e-mail/desktop/FTP server/network folder (SMB)/USB memory
Features	Internet fax*8 (supports direct SMTP), PC-Internet fax transmission*8, mixed size original scanning, LDAP support, 1,000 one-touch dials, 500 group dials, direct entry (address, subject, message), 48 job programmes, broadcasting, long original scanning (max. 1,000 mm)*9, card shot, edge/centre erase

- * 1 : At rated voltage, 23°C. May vary depending on operating conditions and environment.
 * 2 : HDD capacity depends on procurement and sourcing status.
 * 3 : Including document cover. *4: Thumbnails of Document Filing data files and incoming faxes.
 * 5 : Long-edge feeding of A4 sheets from 1st paper tray, using document glass, in Auto Exposure mode, MFP in fully ready condition. May vary depending on operating conditions and environment.
 * 6 : To view XPS files on PCs not running Windows Vista, you must have the XPS Viewer application installed.
 * 7 : Optional MX-EBX3 required. *8: Optional MX-FWX1 required.
 * 9 : B/W documents only, scanned at under 400-dpi resolution. Max. 800 mm for Internet faxing or when scanning at 600 x 600-dpi resolution.
 *10: Measured using Sharp's standard chart (A4 with 6% coverage, B/W). The Quick File Folder shares the HDD with the Job Build function; up to 12GB of data storage is available when using both functions. The storage capacity will be less for colour pages.
 *11: Some features require option(s).
 *12: Optional MX-PKX1 required for Mac OS and EtherTalk.
 *13: PS requires optional MX-PKX1. XPS requires optional MX-PUX1 and MX-ARSMX3 (1GB).
 *14: Some features are not available according to the printer driver used.
 *15: Based on Sharp's standard chart with approx. 700 characters (A4 long-edge feeding) at standard resolution in Super G3 mode, 33,600 bps, JBIG compression.

Document Filing

Document filing capacity	Main and custom folders: 38GB, 20,000 pages*10 or 3,000 files Quick file folder: 12GB, 10,000 pages*10 or 1,000 files
Stored jobs*11	Copy, print, scan, fax transmission
Storage folders	Quick file folder, main folder, custom folder (max. 1,000 folders)
Confidential storage	Password protection

Network Printer

Resolution	600 x 600 dpi
Interface	USB 2.0 10Base-T/100Base-TX/1000Base-T
Supported OS*12	Windows Server® 2003/2008, Windows® 2000/XP, Windows Vista®, Windows 7, Mac OS 9.0 to 9.2.2, Mac OS X 10.2.8, 10.3.9, 10.4.11, 10.5 to 10.5.8, 10.6 to 10.6.2
Network protocols*12	TCP/IP (IPv4, IPv6), IPX/SPX (NetWare), NetBEUI, EtherTalk (AppleTalk)
Printing protocols	LPR, Raw TCP (port 9100), POP3 (e-mail printing), HTTP, Novell Printserver application with NDS and Bindery, FTP for downloading print files, EtherTalk printing, IPP
PDL (emulation)	Standard: PCL 6 emulation Option*13: PS3 emulation, XPS
Available fonts	80 fonts for PCL, 136 fonts for PS3 emulation
Features*11 *14	Network tandem print, RIP Once/Print Many, job retention (print hold, proof print, confidential print), direct PDF/TIFF/JPEG/XPS printing, carbon copy print, duplex print, font/form download, offset output, printer status monitor, pamphlet style, IP/MAC address filtering, port/protocol management, binding edge, N-up (2/4/6/8/9/16), paper/output tray selection, cover/transparency insertion, fit to page, form overlay, auto configuration, barcode font compatibility, tab print, secure network communications (SSL and IPsec [LPD]), watermarks, margin shift

Facsimile (optional MX-FXX2 required)

Compression method	MH/MR/MMR/JBIG
Communication protocol	Super G3/G3
Transmission time	Less than 3 seconds*15
Modem speed	33,600 bps to 2,400 bps with automatic fallback
Transmission resolution	From Standard (203.2 x 97.8 dpi) to Ultra Fine (406.4 x 391 dpi)
Recording width	A3 to A5
Memory	8MB flash memory
Grey scale levels	Equivalent to 256 levels
Features	Duplex transmission/reception, quick on-line transmission, error correction mode, 1,000 one-touch dials, 500 group dials, LDAP support, 48 job programmes, broadcasting number registration, F-Code compatibility (confidential, relay broadcast), polling, memory transmission/reception, auto reduction (transmission/reception), rotation transmission/reception, print actual size, 2-in-1 transmission, long original transmission (max. 1,000 mm), PC-Fax transmission, timer transmission, activity report, anti-junk fax, dual page scan, mixed size original scanning, inbound routing to e-mail/FTP server/network folder (SMB)/PC desktop/group, card shot, edge/centre erase

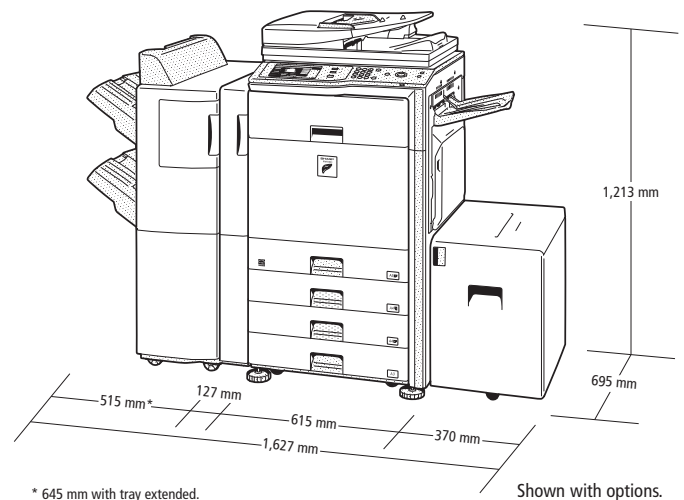

* 645 mm with tray extended.

Shown with options.

SHARP