



ASTRAL
PIPES



**INDIA'S FIRST
LEAD-FREE
UPVC PIPE**



ASTRAL
PIPES

Registered & Corporate Office : Astral Poly Technik Ltd.
207/1, Astral House, B/h Rajpath Club, Off S. G. Highway, Ahmedabad - 380059.
Ph: 079 6621 2000 | Fax: 079 6621 2121 | Website: www.astralpipes.com

For Export Enquiries: export@astralpipes.com

Branch Offices: MUMBAI : 022 - 2838 9744 • PUNE : 0 - 84461 14455 • NEW DELHI : 011 - 2616 9461
• BENGALURU : 080 - 2661 7236 • HYDERABAD : 040 - 2790 0023 • CHENNAI : 044 - 4350 6384
• JAIPUR : 0141 - 297 4322 • LUCKNOW : 0522 - 272 8844 • KOCHI : 0484 - 332 8156



**ASTRAL TOLL FREE
1800 233 7957**
Please get in touch with us
between 10 a.m. to 6 p.m.

AAQ/PC/000
REV:01/06/18

ASTRAL
Aquarius[®]
STANDARDS REDEFINED
UPVC PLUMBING SYSTEM FOR OUTER LOOP LINES



INNOVATION & RECOGNITIONS

- First to introduce CPVC piping system in India (1999)
- First to launch lead free uPVC piping system in India (2004)
- Corp Excel- National SME Excellence Award (2006)
- First to get NSF Certification for CPVC piping system in India (2007)
- First to launch lead free uPVC column pipes in India (2012)
- Enterprising Entrepreneur of the year 2012-13
- Business Standard Star SME of the year (2013)
- Inc. India Innovative 100 for Smart Innovation under category of "Technology" (2013)
- India's Most Promising Brand Award (2014)
- Value Creator Award during the first ever Fortune India Next 500 (2015)
- India's Most Trusted Brand Award (2015)
- India's Most Trusted Pipe Brand Award (2016)
- ET Inspiring Business Leaders of India Award (2016)
- India's Most Attractive Pipe Brand Award (2016)
- Fortune India 500 Company (2016)
- Consumer Validated Superbrands India (2017)

INDEX

Astral - India's Progressive Pipe Company	01
Marketing Network	02
Subsidiaries	03
Certificates & Approvals.....	04
Introduction	05
Key Properties.....	07
The Difference Between uPVC & PVC	08
Field of Applications	08
Standards & Specifications.....	09
Pressure Pipes and Fittings.....	10
PVC Schedule 40 and Schedule 80 Fittings.....	11
Basic Socket Dimensions.....	12
uPVC Pressure Fittings	13
uPVC Pressure Pipes	21
Installation Procedure.....	22
Joint Curing	23
Carrying Capacity and Friction Loss for Schedule 40 Thermoplastic Pipe	24
Carrying Capacity and Friction Loss for Schedule 80 Thermoplastic Pipe	25
Testing Pressure System	26
Expansion and Contraction of uPVC Pipe	27
Underground Installation.....	28
Handling and Storage	31
Frequently Asked Questions About Astral Aquarius®	33
Notes	35



ONLY THOSE PRODUCTS BEARING THE ABOVE MARKS ARE CERTIFIED



ASTRAL - INDIA'S PROGRESSIVE PIPE COMPANY

Astral Poly Technik Limited was established in 1996 with the aim to manufacture pro-india plumbing and drainage systems in the country. While serving the plumbing needs of millions of houses, the company adds extra milage to india's developing real estate fraternity. Our contribution to the plumbing industry in the form of being pro-innovative bears the hallmark of unbeaten quality. Astral Poly Technik Limited is equipped with production facilities at Santej & Dholka (Gujarat), and Hosur (Tamil nadu) to manufacture Plumbing systems, Drainage ststems, Agriculture Systems, Industrial Piping, Fire Sprinkler Piping Systems and Electrical Conduit Pipes with all kinds of ecessary fittings. We are also known as pro- customers' company as we serve with an intention of taking excellence to new heights. Through our quality products and services we have also achieved the benchmark of being Pro-India Company in numerous ways. Astral Pipes has been awarded as 'ASTRAL – India's Most Trusted Brand in the category of Pipes' according to 'The Brand Trust Report, India Study 2016', and also won place in 'Consumers Superbrands Edition 2016-17' becoming consumer validated Superbrand in Piping category. Our incessant focus on quality piping leads us to be prominent player in the categoxy and a wellknown piping brand.



MARKETING NETWORK

ASTRAL has marketing network of more than 800 distributors and 25,000 dealers spread all over India with branch offices at Mumbai, Pune, Delhi, Bengaluru, Chennai, Hyderabad, Jaipur, Lucknow, Kochi and Indore apart from that ASTRAL has its own warehouses at Bengaluru, Coimbatore, Hyderabad, Vijaywada, Kolkata, Ghaziabad, Kolhapur, Indore and Nagpur to deliver the material as quick as possible. More than 300 techno marketing professionals and administrative personnel are on the board to coordinate with architects, plumbing contractors and plumbers to utilize the best plumbing techniques and to get the best from the product.





SUBSIDIARIES



Resinova manufactures a diversified range of adhesives, sealants, putties and construction aids. Our products are mostly pioneering efforts where advantages has been taken of our knowledge of different chemistries such as epoxy, silicones, acrylics, cyanoacrylates, UV care, PVA etc. Our products stand for quality and reliability and are marketed through a network of about more than 2000 distributors and 4,50,000 dealers across the country.



For almost two decades, Bond It has been a manufacturer of high performance, high quality building chemicals such as sealants, adhesives, grouts, cleaners, expanding foams, fillers, decorating sundries, landscaping products and other similar products.



Seal IT Services Limited, a UK based subsidiary of the Astral Poly Technik Ltd. has entered into U.S. market by acquiring silicone tape business of Rowe Industries Inc., USA.



CERTIFICATES & APPROVALS

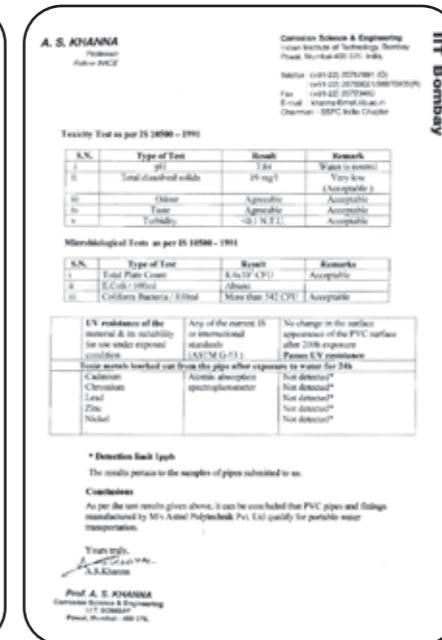
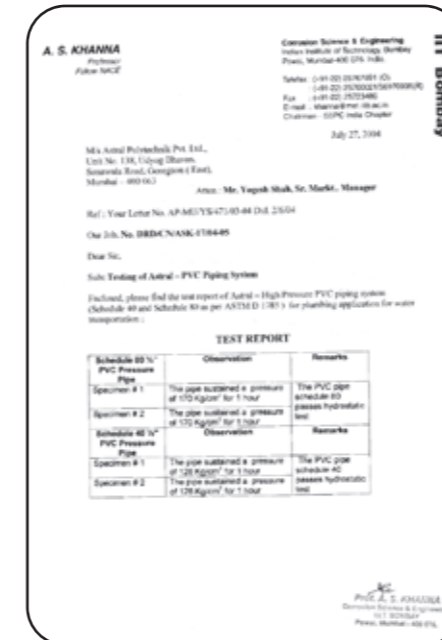



INTRODUCTION



ASTRAL Aquarius ASTM uPVC pipes and fittings are Lead Free and hence non toxic, easy to install and are made for life time trouble free service. ASTRAL Aquarius pipes and fittings are available in range of 15 mm (1/2") to 300 mm (12") with two different class SCH 40 and SCH 80.

As the full line leading manufacturer of CPVC pipes and fittings for residential and industrial applications and now with ASTM uPVC pressure pipes and fittings, ASTRAL can be your one stop source for all the plastic piping system you require for lifetime plumbing solution.

PVC - POLYVINYL CHLORIDE

PVC is one of the specified thermoplastic for piping system components, including valves, fittings, flanges and many speciality products. PVC has excellent chemical and corrosion resistance to a broad range of fluids. ASTRAL uPVC materials conform to ASTM Cell Classification 12454-B of ASTM D1784 (formally designated as Type I, Grade I). The maximum recommended service temperature of PVC products is 60°C (140°F)



WHAT MAKES PVC IMPORTANT?

PVC makes a major contribution to the quality, safety and cost-effectiveness of construction materials, as well as helping to reduce the environmental impact of completed projects.

PVC is the most widely used polymer in building and construction applications and over 50 percent of Western Europe's annual PVC production is used in this sector. PVC has a versatility that helps to meet modern and future design needs.

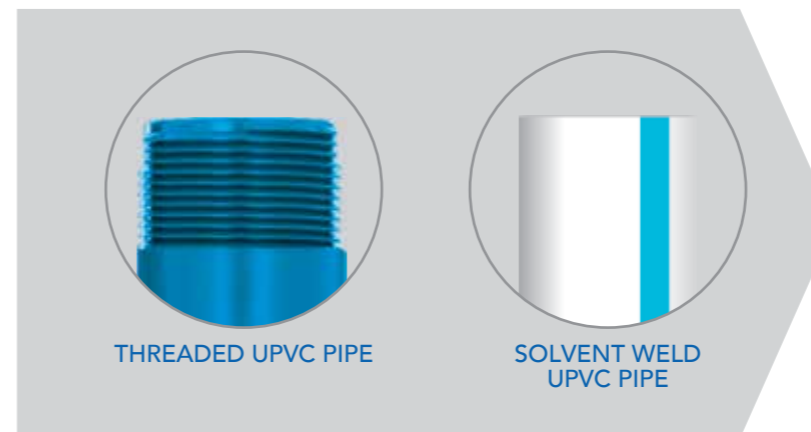

BENEFITS OF ASTRAL AQUARIUS SYSTEM OVER OTHER uPVC SYSTEMS

ASTRAL Aquarius uPVC pipes being lead free are non-toxic and hence favoured for use in applications such as potable water pipes. ASTRAL Aquarius uPVC Plumbing system utilizes NSF (National Sanitation Foundation) approved one-step solvent cement, specifically formulated for the use. Joining is accomplished quickly and efficiently utilizing inexpensive tools thereby greatly reducing labour and installation costs.

ASTRAL Aquarius uPVC pipes & fittings exhibit the well-known physical characteristics and other benefits of conventional uPVC piping such as good chemical and corrosion resistance, low thermal conductivity, high strength-to-weight ratio, good impact resistance and ease of installation.

ASTRAL Aquarius uPVC solvent joint plumbing system makes its pressure bearing capacity twice than that of the threaded pipe.



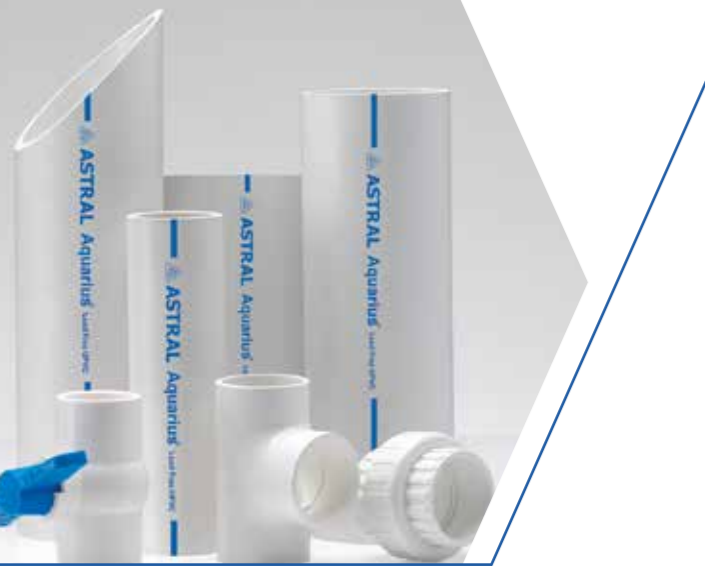

KEY PROPERTIES

The key properties of ASTRAL Aquarius high pressure Lead Free Plumbing System are significant with following features

STRONG AND LIGHT WEIGHT

ASTRAL Aquarius Lead Free Plumbing System is tough, durable with high tensile and impact strength. The system is light in weight and can be transported easily from one place to another.

EASY TO INSTALL

ASTRAL Aquarius Lead Free pipes can be cut, shaped, welded and jointed easily.

FIRE RESISTANT

ASTRAL Aquarius Lead Free Plumbing System is inherently difficult to ignite and stops burning once the source of heat is removed. Compared to its common plastic alternatives PVC performs better in terms of lower combustibility, flammability, flame propagation and heat release. Newly developed advantages in terms of lower acid emissions, smoke generation and enhanced fire resistance.

DURABLE

ASTRAL Aquarius Lead Free Plumbing System is durable and free from weaknesses caused by rusting, weathering and chemical action and hence last for life time.

UV STABILIZED

ASTRAL Aquarius Lead Free Plumbing System can be used in sunlight exposed conditions. However, ASTRAL recommends a standard grade of exterior latex paint (water base) which will protect the system adequately. SIMPLE AND LEAK PROOF JOINTS Jointing can be done speedily with special IPS solvent cement supplied by the company which ensures 100% leak proof joints.

SAFE MATERIAL FOR DRINKING WATER

ASTRAL Aquarius pipes are non-toxic and lead free which makes them a safe material for potable water. It is also the world's most researched and thoroughly tested material for PVC which meets all international standards for safety and health for both the products and applications.

MAXIMUM FLOW RATE

Smooth inner surface ensures high flow rate and low friction losses. The system is leach and scale free.

GOOD INSULATOR

PVC does not conduct electricity. ASTRAL Aquarius pipes are non conductor of electricity so it make the plumbing system safe when working with electrical tools or equipments.

CHEMICAL RESISTANCE

uPVC is generally inert to most mineral acids, bases, salts and paraffinic hydrocarbon solutions. For more information on uPVC chemical resistance refer to Chemical Resistance of Rigid Vinyls Based.

WIDE RANGE

ASTRAL Aquarius Lead Free Plumbing System available from 1/2" (15 mm) to 12" (300 mm) with wide range of fittings, transition fittings, valves and specially designed brass inserted fittings to suit any design criteria.

THE DIFFERENCE BETWEEN uPVC & PVC

There has been a lot of confusion in the thermoplastics industry regarding the use of the terms uPVC and PVC when specifying thermoplastic piping products. For many years, certain regions of the world have preferred using the term uPVC when specifying unplasticized Polyvinyl Chloride piping products while other regions of the world, The United State of America for instance, prefer the acronym PVC (less the U) when specifying the same unplasticized PVC piping products. Essentially, both references indicate that the type of PVC required be unplasticized, rigid PVC. The most important aspect of specifying PVC piping products is not the abbreviation but the cell classification of the thermoplastic material. For rigid, unplasticized Type I Grade 1 PVC material with a hydrostatic design stress of 2000psi the cell classification is 12454. These numbers indicate the minimum physical properties that a rigid, unplasticized thermoplastic compound must meet per ASTM D1784 to be used in the manufacture of pressure piping components. In summary, whether a thermoplastic vinyl piping, product is specified as uPVC is not important, it is the cell classification, and materials' physical properties that is most important.



FIELD OF APPLICATIONS

- Cold Water Plumbing Application
- Water Distribution Mains
- Industrial Process Lines
- Swimming Pools
- Plants & Tanning Plants
- Hand Pumps
- Sugar, Paper & Distillery Industries
- Salt Water Line
- Aggressive Corrosive Fluid Transportation
- Coal Washing & Ash Handling
- Ring Lines
- Down Take Lines



STANDARDS & SPECIFICATIONS

- ASTM D 1784** - Rigid Poly Vinyl Chloride (PVC) Compounds.
- ASTM D 1785** - Poly Vinyl Chloride (PVC) Plastic Pipes, SCH 40 & SCH 80.
- ASTM D 2466** - Socket type Poly Vinyl Chloride (PVC) Plastic Pipe Fittings, SCH 40.
- ASTM D 2467** - Socket type Poly Vinyl Chloride (PVC) Plastic Pipe Fittings, SCH 80.
- ASTM D 2564** - Solvent Cements for Plastic Pipes & Fittings
- ASTM F 1498** - Taper Pipe threads 60° for Thermoplastics Pipe & Fittings
- ASTM D 2774** - Underground Installation of Thermoplastic Pipes.
- ISO 7/1** - Pipe threads where pressure joints are made on threads - Part 1 : Designation, Dimension & Tolerances.

DESCRIPTIVE CODES

- ASTM - American Society for Testing of Materials.
- BSP - British Standard Pipe
- NPT - National Pipe Threads (ANSI)
- MIPT - Male Iron Pipe Threads
- SPIGOT - Spigot End (IPS)
- MBSP - Male BSP Threads
- PVC - Poly Vinyl Chloride
- ANSI - American National Standards Institute
- IPS - Iron Pipe Size (ASTM)
- FIPT - Female Iron Pipe Threads
- SOCKET - Solvent Weld Socket
- FBSP - Female BSP Threads
- NSF - National Sanitation Foundation
- EPDM - Ethylene Propylene Rubber

IMPORTANT FOR INSTALLERS & USERS:

WATER HAMMER

ASTRAL recommends that all uPVC Plastic piping systems be designed and constructed to avoid excessive WATER HAMMER. Water hammer can cause damage and failure to pipe, valves and fittings within the piping system

THREADED CONNECTIONS :

Use a quality grade thread sealant. Do not use substances that could cause stress cracking to plastic. Major attention must be given while making plastic thread joints. 1 to 2 turns beyond FINGER TIGHT is generally all that is required to make a sound plastic connection. Unnecessary OVER TIGHTENING will cause DAMAGE TO BOTH PIPES & FITTINGS. Also give proper attention while selecting the threaded fittings, as ASTRAL manufacture some fittings with NPT threads & some fittings with BSP threads to give more versatility to customer NPT threads are not compatible with BSP threads.

SEAL & GASKET LUBRICANTS

Some Lubricants, including vegetable oils are known to cause stress cracking in thermoplastics materials. A mild soap or commercially available pipe gasket lubricants suitable for uPVC is recommended where lubrication is required for installation or maintenance service (especially with Flange joints). Choice of lubricant is at the discretion of the installer.

FLOW VELOCITIES:

System should not be operated or flushed out at flow velocities greater than 5 feet per second.

PRESSURE PIPES AND FITTINGS

PRESSURE RATING @23°C uPVC SCHEDULE 40

Part No.	Nominal Size		Average Outside Diameter		Minimum Wall Thickness		Maximum Work Pressure at 73°F PSI	Maximum Work Pressure at 23°C (kg/cm ²)
	(in.)	(mm)	(in.)	(mm)	(in.)	(mm)		
M051400301	½	15	0.840	21.34	0.109	2.77	600	42.19
M051400302	¾	20	1.050	26.67	0.113	2.87	480	33.75
M051400303	1	25	1.315	33.40	0.133	3.38	450	31.64
M051400304	1¼	32	1.660	42.16	0.140	3.56	370	26.01
M051400305	1½	40	1.900	48.26	0.145	3.68	330	23.20
M051400306	2	50	2.375	60.32	0.154	3.91	280	19.69
M051400307	2½	65	2.875	73.02	0.203	5.16	330	21.09
M051400308	3	80	3.500	88.90	0.216	5.49	260	18.28
M051400309	4	100	4.500	114.30	0.237	6.02	220	15.47
M051400310	6	150	6.625	168.28	0.280	7.11	180	12.66
M051400311	8	200	8.625	219.08	0.322	8.18	160	11.25
M051400312	10	250	10.750	273.05	0.365	9.27	140	9.84
M051400313	12	300	12.750	323.85	0.406	10.31	130	9.14

Mpa = Mega Pascal 1 MPa = 10 kg / cm² 1 kg / cm² = 14.223343 PSI.

PRESSURE RATING @23°C uPVC SCHEDULE 80

Part No.	Nominal Size		Average Outside Diameter		Minimum Wall Thickness		Maximum Work Pressure at 73°F PSI	Maximum Work Pressure at 23°C (kg/cm ²)
	(in.)	(mm)	(in.)	(mm)	(in.)	(mm)		
M051800301	½	15	0.840	21.34	0.147	3.73	850	59.76
M051800302	¾	20	1.050	26.67	0.154	3.91	690	48.51
M051800303	1	25	1.315	33.40	0.179	4.55	630	44.29
M051800304	1¼	32	1.660	42.16	0.191	4.85	520	36.56
M051800305	1½	40	1.900	48.26	0.200	5.08	470	33.04
M051800306	2	50	2.375	60.32	0.218	5.54	400	28.12
M051800307	2½	65	2.875	73.02	0.276	7.01	420	29.53
M051800308	3	80	3.500	88.90	0.300	7.62	370	26.01
M051800309	4	100	4.500	114.30	0.337	8.56	320	22.50
M051800310	6	150	6.625	168.28	0.432	10.97	280	19.69
M051800311	8	200	8.625	219.08	0.500	12.70	250	17.57
M051800312	10	250	10.750	273.05	0.593	15.06	230	16.17
M051800313	12	300	12.750	323.85	0.687	17.45	230	16.17

Mpa = Mega Pascal 1 MPa = 10 kg / cm² 1 kg / cm² = 14.223343 PSI.

TEMPERATURE PRESSURE DE-RATING FACTOR

The operating pressure of uPVC pipe will be reduced as the operating temperature increases above 23°C (73° F). To calculate this reduction, multiply the operating pressure with the correction factors shown below at a operating temperature of system :

Operating Temp. °C(F)	23°(73)	27°(80)	32°(90)	38°(100)	43°(110)	49°(120)	54°(130)	60°(140)
uPVC	100%	90%	75%	62%	50%	40%	30%	22%

NOTE :

- (1) Valves, Unions and Specialty Products have different elevated temperature ratings than pipes.
- (2) Threaded valves should not be used at temperature above 110°F (43° C) for PVC
- (3) Flanged joints have a base pressure rating of 150 PSI at 23° C

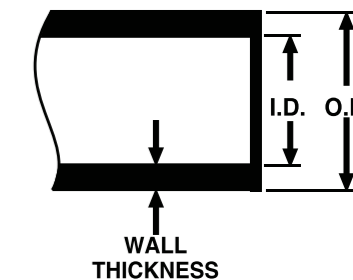

PVC SCHEDULE 40 AND SCHEDULE 80 FITTINGS



The following information is provided as a guide only. Actual allowable working pressure may vary widely according to field conditions. Additionally, pressure de-rating at elevated temperatures must be taken into account. Certain fitting configurations may have other assigned pressure limitations (i.e., Wyes, Unions, Flanges, Valves etc). Contact Astral Technical Services for additional information.

PRESSURE RATING @23°C uPVC SCHEDULE 40

Nominal Size (in.)	Schedule 40 (kg/cm ²)			Schedule 80 (kg/cm ²)		
	Pipe ¹	Solvent Cemented Joint	Standard Threaded Joint ³	Pipe ¹	Solvent Cemented Joint	Standard Threaded Joint ³
1/2	42.19	25.31	21.09	59.76	35.85	29.88
3/4	33.75	20.24	16.87	48.51	29.10	24.25
1	31.64	18.98	15.81	44.29	26.57	22.14
1 1/4	26.01	15.60	13.00	36.56	21.93	18.27
1 1/2	23.20	13.92	11.60	33.04	19.82	16.52
2	19.69	11.81	9.84	28.12	16.87	14.06
2 1/2	21.09	12.65	10.54	29.53	17.71	14.76
3	18.28	10.96	9.13	26.01	15.60	13.00
4	15.47	9.28	7.73	22.50	13.49	11.24
6	12.66	7.59	6.32	19.69	11.81	9.84
8	11.25	6.74	5.62	17.57	10.54	8.78
10	9.84	5.90	4.92	16.17	9.70	8.08
12	9.14	5.48	4.56	16.17	9.70	8.08

NOTES : (1) Water pressure Ratings At 73°F (23°C) for Schedule 40 and Schedule 80 Plastic Pipe, ASTM D 1785 for PVC.

(2) Threading of Schedule 40 plastic pipe is not permitted. Recommended pressures apply to molded fittings only.

Not For Use With

Compressed Air or Gas

PHYSICAL PROPERTIES OF PVC MATERIALS

PROPERTY	UNITS	PVC	ASTM NO.
Specific Gravity	g/cc	1.41 - 1.46	D 792
Tensile Strength (73°F)	PSI	7,200	D 638
Modulus of Elasticity in Tension (73°F)	PSI	4,60,000	D 638
Flexural Strength (73°F)	PSI	13,200	D 790
Izod Impact (notched at 73°F)	ft lb/in.	0.65	D 256
Hardness (Durometer D)	----	80 ± 3	D 2240
Hardness (Rockwell R)	----	110 - 120	D 785
Compressive Strength (73°F)	PSI	9,000	D 695
Hydrostatic Design Stress	PSI	2,000	D 1598
Coefficient of Linear Expansion	in./in./°F	3.1 x 10-5	D 696
Heat Deflection Temperature at 66 psi	degrees °F	165	D 648
Coefficient of Thermal Conductivity	BTU/hr/sq. ft/°F/in.	1.2	C 177
Specific Heat	BTU/F/lb	0.25	D 2766
Limiting Oxygen Index	%	43	D 2863
Water Absorption (24 hrs at 73°F)	% weight gain	0.05	D 570
Cell Classification - Pipe	----	12454-B	D 1784
Cell Classification - Fittings	----	12454-B	D 1784

Above data is based upon information provided by the raw material manufacturers. It should be used only as a recommendation and not as a guarantee of performance.

BASIC SOCKET DIMENSIONS

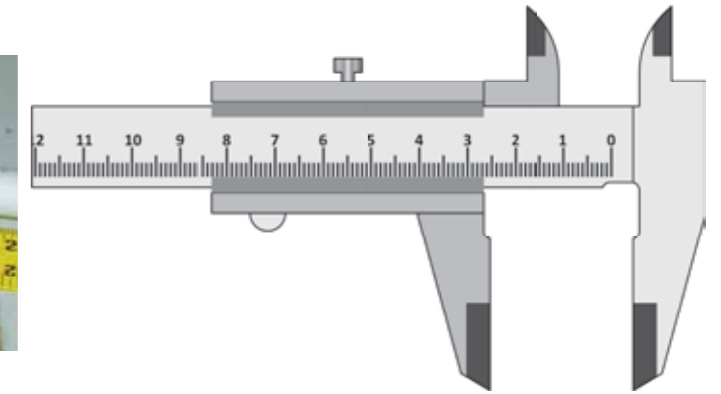

SCHEDULE 40 AS PER ASTM D-2466, SCHEDULE 80 AS PER ASTM D-2467

Nominal Size (in.)	Diameter (mm)	Diameter (in.)		Tolerance	Socket Length Minimum C (in.)	
		Entrance A	BOTTOM B		SCH 40	SCH 80
1/2	15	0.848	0.836	±0.004	0.688	0.875
3/4	20	1.058	1.046	±0.004	0.719	1.000
1	25	1.325	1.310	±0.005	0.875	1.125
1 1/4	32	1.670	1.655	±0.005	0.938	1.250
1 1/2	40	1.912	1.894	±0.006	1.094	1.375
2	50	2.387	2.369	±0.006	1.156	1.500
2 1/2	65	2.889	2.868	±0.007	1.750	1.750
3	80	3.516	3.492	±0.008	1.875	1.875
4	100	4.518	4.491	±0.009	2.000	2.250
6	150	6.647	6.614	±0.011	3.000	3.000
8	200	8.655	8.610	±0.015	4.000	4.000
10	250	10.780	10.735	±0.015	5.000	5.000
12	300	12.780	12.735	±0.015	6.000	6.000

AMERICAN NATIONAL STANDARD TAPER PIPE THREADS (NPT) ANSI STANDARD B1.20.1 ASTM STANDARD F 1498

Nominal Size (in.)	(mm)	Threads Per in.	Effective Thread Length L	Pitch of Thread P
1/2	15	14	0.5337	0.07143
3/4	20	14	0.5457	0.07143
1	25	11 1/2	0.6828	0.08696
1 1/4	32	11 1/2	0.7068	0.08696
1 1/2	40	11 1/2	0.7235	0.08696
2	50	11 1/2	0.7565	0.08696
2 1/2	65	8	1.1375	0.12500
3	80	8	1.2000	0.12500
4	100	8	1.3000	0.12500

BSP ISO 7/1 PARELLEL THREADS

Nominal Size (in.)	(mm)	Threads Per in.	Effective Thread Length L	Pitch of Thread P
1/2	15	14	13.152	1.8143
3/4	20	14	14.514	1.8143
1	25	11	16.714	2.3091
1 1/4	32	11	19.050	2.3091
1 1/2	40	11	19.050	2.3091
2	50	11	23.378	2.3091
2 1/2	65	11	26.698	2.3091
3	80	11	29.873	2.3091
4	100	11	35.791	2.3091

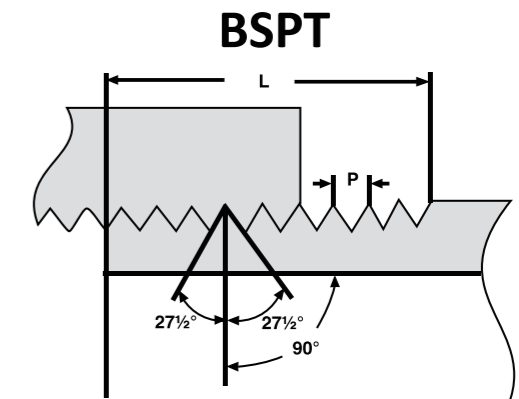
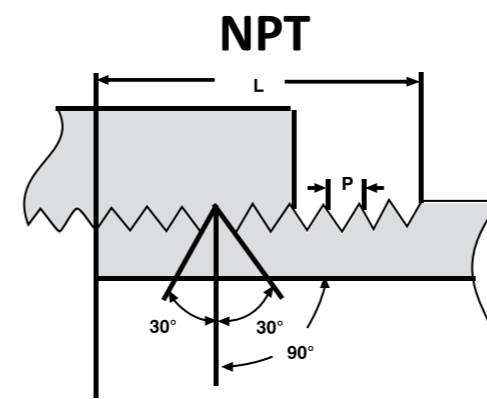

uPVC PRESSURE FITTINGS

SCHEDULE 40 AS PER ASTM D-2466 AND SCHEDULE 80 AS PER ASTM D-2467

TEE - SOC

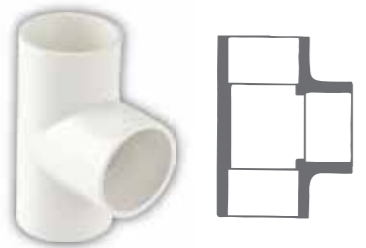

Size (in.)	Size (mm)	SCHEDULE 40		SCHEDULE 80	
		Part No.	Std Pkg Bag/Case	Part No.	Std Pkg Bag/Case
1/2	15	M052400101	50 / 550	M052800101	50 / 200
3/4	20	M052400102	25 / 300	M052800102	25 / 125
1	25	M052400103	25 / 175	M052800103	10 / 70
1 1/4	32	M052400104	10 / 100	M052800104	10 / 40
1 1/2	40	M052400105	10 / 70	M052800105	5 / 30
2	50	M052400106	5 / 40	M052800106	5 / 15
2 1/2	65	M052400107	1 / 27	M052800107	1 / 12
3	80	M052400108	1 / 18	M052800108	1 / 7
4	100	M052400109	1 / 10	M052800109	1 / 4
6	150	M052400110	1 / 2	M052800110	1 / 2
8	200	-	-	M052800111	1 / 1

REDUCING TEE - SOC

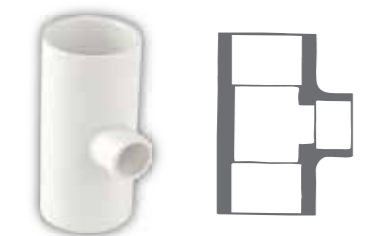

Size (in.)	Size (mm)	Part No.	Std Pkg Bag/Case	Part No.	Std Pkg Bag/Case
3/4 x 1/2	20 x 15	M052400214	25 / 350	M052800214	25 / 150
1 x 1/2	25 x 15	M052400215	25 / 200	M052800215	25 / 100
1 x 3/4	25 x 20	M052400216	25 / 175	M052800216	25 / 100
1 1/4 x 1/2	32 x 15	M052400217	10 / 120	M052800217	10 / 60
1 1/4 x 3/4	32 x 20	M052400218	10 / 100	M052800218	10 / 60
1 1/4 x 1	32 x 25	M052400219	10 / 100	M052800219	10 / 50
1 1/2 x 1/2	40 x 15	M052400220	10 / 50	M052800220	10 / 40
1 1/2 x 3/4	40 x 20	M052400221	10 / 40	M052800221	10 / 40
1 1/2 x 1	40 x 25	M052400222	10 / 80	M052800222	10 / 40
1 1/2 x 1 1/4	40 x 32	M052400223	10 / 70	M052800223	10 / 30
2 x 1/2	50 x 15	M052400224	5 / 60	M052800224	5 / 30
2 x 3/4	50 x 20	M052400225	5 / 60	M052800225	5 / 25
2 x 1	50 x 25	M052400226	5 / 60	M052800226	5 / 20
2 x 1 1/4	50 x 32	M052400227	5 / 50	M052800227	5 / 20
2 x 1 1/2	50 x 40	M052400228	5 / 50	M052800228	5 / 20
2 1/2 x 1	65 x 25	-	-	M052800231	15
2 1/2 x 1 1/4	65 x 32	-	-	M052800232	15
2 1/2 x 1 1/2	65 x 40	-	-	M052800233	15
2 1/2 x 2	65 x 50	-	-	M052800234	12
3 x 1	80 x 25	-	-	M052800237	10
3 x 1 1/4	80 x 32	-	-	#M052800238	-
3 x 1 1/2	80 x 40	-	-	M052800239	10
3 x 2	80 x 50	-	-	M052800240	9
3 x 2 1/2	80 x 65	-	-	M052800241	9
4 x 1	100 x 25	-	-	M052800244	5
4 x 1 1/4	100 x 32	-	-	M052800245	5
4 x 1 1/2	100 x 40	-	-	M052800246	5
4 x 2	100 x 50	* 401-420	5 / --	M052800247	5
4 x 2 1/2	100 x 65	-	-	M052800248	5
4 x 3	100 x 80	* 401-422	5 / --	M052800249	5
6 x 4	150 x 100	* 401-532	1 / --		

TEE - SOC X FIPT

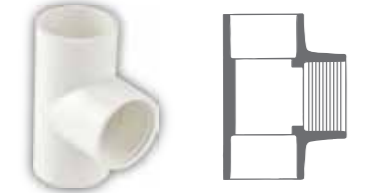

Size (in.)	Size (mm)	Part No.	Std Pkg Bag/Case	Part No.	Std Pkg Bag/Case
1/2	15	M052400401	50 / 350		
3/4	20	M052400402	25 / 150		
1	25	M052400403	25 / 75		
1 1/4	32	M052400404	10 / 50		
1 1/2	40	M052400405	10 / 40		
2	50	M052400406	5 / 20		

uPVC PRESSURE FITTINGS

SCHEDULE 40 AS PER ASTM D-2466 AND SCHEDULE 80 AS PER ASTM D-2467

BRASS TEE - SOC X FIPT

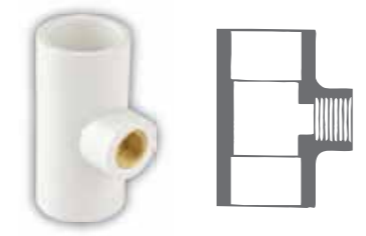

Size (in.)	Size (mm)	SCHEDULE 40		SCHEDULE 80	
		Part No.	Std Pkg Bag/Case	Part No.	Std Pkg Bag/Case
1/2 x 1/2	15 x 15			M052800301	25 / 100
3/4 x 1/2	20 x 15			M052800314	25 / 50
3/4 x 3/4	20 x 20			M052800302	25 / 50
1 x 1/2	25 x 15			M052800315	25 / 25
1 x 3/4	25 x 20			M052800316	25 / 25
1 x 1	25 x 25			M052800303	10 / 30
1 1/4 x 1/2	32 x 15			M052800317	10 / 20

90° ELBOW - SOC



Size (in.)	Size (mm)	Part No.	Std Pkg Bag/Case	Part No.	Std Pkg Bag/Case
1/2	15	M052400501	100 / 100	M052800501	50 / 300
3/4	20	M052400502	50 / 500	M052800502	50 / 200
1	25	M052400503	25 / 250	M052800503	25 / 125
1 1/4	32	M052400504	10 / 150	M052800504	10 / 60
1 1/2	40	M052400505	10 / 110	M052800505	10 / 50
2	50	M052400506	5 / 65	M052800506	5 / 25
2 1/2	65	M052400507	1 / 35	M052800507	5 / 15
3	80	M052400508	1 / 25	M052800508	1 / 10
4	100	M052400509	1 / 14	M052800509	1 / 5
6	150	M052400510	1 / 3	M052800510	1 / 2
8	200	-	-	M052800511	1 / 1

90° ELBOW - SOC X FIPT



Size (in.)	Size (mm)	Part No.	Std Pkg Bag/Case	Part No.	Std Pkg Bag/Case
1/2	15	M052400801	100 / 300		
3/4	20	M052400802	50 / 200		
1	25	M052400803	25 / 100		
1 1/4	32	M052400804	10 / 50		
1 1/2	40	M052400805	10 / 40		
2	50	M052400806	5 / 25		

BRASS 90° ELBOW - SOC X FIPT



Size (in.)	Size (mm)	Part No.	Std Pkg Bag/Case	Part No.	Std Pkg Bag/Case
1/2 x 1/2	15 x 15			M052800701	25 / 100
3/4 x 1/2	20 x 15			M052800714	25 / 100
3/4 x 3/4	20 x 20			M052800702	25 / 75
1 x 1/2	25 x 15			M052800715	25 / 50
1 x 1	25 x 25			M052800703	10 / 50
# 1 x 3/4	25 x 20			M052800716	-

45° ELBOW - SOC



Size (in.)	Size (mm)	Part No.	Std Pkg Bag/Case	Part No.	Std Pkg Bag/Case
1/2	15	M052402301	100 / 500	M052802301	100 / 400
3/4	20	M052402302	50 / 300	M052802302	50 / 200
1	25	M052402303	25 / 325	M052802303	25 / 150
1 1/4	32	M052402304	10 / 100	M052802304	10 / 80
1 1/2	40	M052402305	15 / 75	M052802305	10 / 60
2	50	M052402306	10 / 40	M052802306	5 / 30
2 1/2	65	* 417-025	5 / --	M052802307	5 / 20
3	80	* 417-030	5 / --	M052802308	1 / 12
4	100	* 417-040	5 / --	M052802309	1 / 6

uPVC PRESSURE FITTINGS

SCHEDULE 40 AS PER ASTM D-2466 AND SCHEDULE 80 AS PER ASTM D-2467

REDUCER ELBOW



Size (in.)	Size (mm)	SCHEDULE 40		SCHEDULE 80	
		Part No.	Std Pkg Bag/Case	Part No.	Std Pkg Bag/Case
¾ x ½	20 x 15	-	-	M052800614	50 / 200
1 x ½	25 x 15	-	-	M052800615	25 / 150
1 x ¾	25 x 20	-	-	M052800616	25 / 150

CROSS - SOC

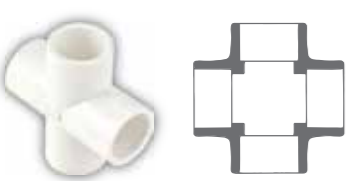

Size (in.)	Size (mm)	Part No.	Std Pkg Bag/Case	Part No.	Std Pkg Bag/Case
½	15	M052402401	50 / 200		
¾	20	M052402402	25 / 100		
1	25	* 420-010	10 / --		
1¼	32	* 420-012	10 / --		
1½	40	* 420-015	10 / --		
2	50	* 420-020	10 / --		
2½	65			M052802407	1 / 9
3	80			M052802408	1 / 6

REDUCER COUPLING SOC



Size (in.)	Size (mm)	Part No.	Std Pkg Bag/Case	Part No.	Std Pkg Bag/Case
¾ x ½	20 x 15	M052401114	100 / 400		
1 x ½	25 x 15	M052401115	50 / 550		
1 x ¾	25 x 20	M052401116	50 / 200		
1¼ x 1	32 x 25	M052401119	25 / 175		
1½ x 1	40 x 25	M052401122	25 / 150	# M052801122	-
1½ x 1¼	40 x 32	M052401123	10 / 150		
2 x 1	50 x 25	M052401126	30 / 120	M052801126	15 / 75
2 x 1¼	50 x 32	M052401127	10 / 40	# M052801127	-
2 x 1½	50 x 40	M052401128	10 / 50	M052801128	10 / 50
2½ x 1¼	65 x 32			M052801132	8 / 48
2½ x 1½	65 x 40	* 429-291	-	M052801133	5 / 40
2½ x 2	65 x 50	* 429-292	-	M052801134	5 / 40
3 x 1½	80 x 40			M052801139	1 / 27
3 x 2	80 x 50	* 429-338	5 / --	M052801140	5 / 25
3 x 2½	80 x 65	* 429-339	-	M052801141	5 / 25
4 x 1½	100 x 40			M052801146	1 / 16
4 x 2	100 x 50	* 429-420	5 / --	M052801147	1 / 16
4 x 2½	100 x 65	* 429-421	-	M052801148	1 / 15
4 x 3	100 x 80	* 429-422	5 / --	M052801149	1 / 15

COUPLING SOC



Size (in.)	Size (mm)	Part No.	Std Pkg Bag/Case	Part No.	Std Pkg Bag/Case
½	15	M052401001	100 / 1400	M052801001	100 / 400
¾	20	M052401002	50 / 300	M052801002	50 / 300
1	25	M052401003	25 / 350	M052801003	25 / 150
1¼	32	M052401004	10 / 200	M052801004	10 / 80
1½	40	M052401005	10 / 150	M052801005	10 / 70
2	50	M052401006	10 / 100	M052801006	10 / 50
2½	65	M052401007	5 / 50	M052801007	5 / 20
3	80	M052401008	5 / 35	M052801008	5 / 15
4	100	M052401009	1 / 24	M052801009	1 / 12
6	150	M052401010	1 / 2	M052801010	1 / 2
8	200	-	-	M052801011	1 / 1
10	250	-	-	M052801012	1 / 1
12	300	-	-	M052801013	1 / 1

uPVC PRESSURE FITTINGS

SCHEDULE 40 AS PER ASTM D-2466 AND SCHEDULE 80 AS PER ASTM D-2467

BRASS REDUCER BUSH



Size (in.)	Size (mm)	SCHEDULE 40		SCHEDULE 80	
		Part No.	Std Pkg Bag/Case	Part No.	Std Pkg Bag/Case
1 x ½	25 x 15			M052802015	50 / 250

BRASS MALE ADAPTER - SOC X MBSP

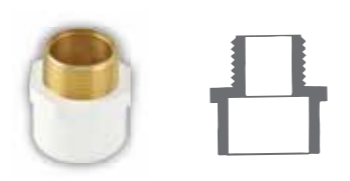

Size (in.)	Size (mm)	Part No.	Std Pkg Bag/Case	Part No.	Std Pkg Bag/Case
½	15			M052801401	50 / 250
¾	20			M052801402	25 / 100
1	25			M052801403	25 / 100
1¼	32			M052801404	10 / 50
1½	40			M052801405	10 / 40
2	50			M052801406	5 / 20
¾ x ½	20 x 15			M052801414	25 / 150
1 x ½	25 x 15			M052801415	25 / 100
1 x ¾	25 x 20			M052801416	25 / 100

BRASS FEMALE ADAPTER - SOC X FBSP



Size (in.)	Size (mm)	Part No.	Std Pkg Bag/Case	Part No.	Std Pkg Bag/Case
½	15			M052801701	25 / 100
¾	20			M052801702	25 / 100
1	25			M052801703	25 / 50
1¼	32			M052801704	10 / 40
1½	40			M052801705	10 / 30
2	50			M052801706	5 / 15
¾ x ½	20 x 15			M052801714	25 / 100
1 x ½	25 x 15			M052801215	25 / 100
1 x ¾	25 x 20			M052801216	25 / 75

MALE ADAPTER - SOC X MBSP



Size (in.)	Size (mm)	Part No.	Std Pkg Bag/Case	Part No.	Std Pkg Bag/Case
½	15	M052401301	100 / 1700	M052801301	100 / 600
¾	20	M052401302	50 / 500	M052801302	50 / 400
1	25	M052401303	50 / 500	M052801303	50 / 250
1¼	32	M052401304	20 / 480	M052801304	10 / 150
1½	40	M052401305	16 / 320	M052801305	10 / 100
2	50	M052401306	12 / 192	M052801306	10 / 60
2½	65	* 336-025	10 / --	M052801307	5 / 30
3	80	* 336-030	10 / --	M052801308	5 / 20
4	100	* 336-040	6 / --	M052801309	1 / 15
6	150	* 336-060	3 / --		
¾ x ½	20 x 15	-	-	M052801314	50 / 400

FEMALE ADAPTER - SOC x FBSP



Size (in.)	Size (mm)	Part No.	Std Pkg Bag/Case	Part No.	Std Pkg Bag/Case
½	15	M052401601	100 / 1300	M052801601	100 / 600
¾	20	M052401602	50 / 400	M052801602	50 / 400
1	25	M052401603	25 / 400	M052801603	25 / 200
1¼	32	M052401604	10 / 130	M052801604	10 / 100
1½	40	M052401605	10 / 100	M052801605	10 / 80
2	50	M052401606	10 / 70	M052801606	10 / 50
2½	65			M052801607	5 / 30
3	80			M052801608	5 / 20
4	100			M052801609	1 / 12
¾ x ½	20 x 15	M052401614	50 / 700		

uPVC PRESSURE FITTINGS

SCHEDULE 40 AS PER ASTM D-2466 AND SCHEDULE 80 AS PER ASTM D-2467

REDUCER BUSHING (FLUSH STYLE)



Size (in.)	Size (mm)	SCHEDULE 40		SCHEDULE 80	
		Part No.	Std Pkg Bag/Case	Part No.	Std Pkg Bag/Case
¾ x ½	20 x 15	M052401914	100 / 900	M052801914	100 / 300
1 x ½	25 x 15	M052401915	50 / 450	M052801915	50 / 400
1 x ¾	25 x 20	M052401916	50 / 450	M052801916	50 / 400
1¼ x ½	32 x 15	M052401917	25 / 300	M052801917	25 / 250
1¼ x ¾	32 x 20	M052401918	25 / 300	M052801918	25 / 250
1¼ x 1	32 x 25	M052401919	25 / 500	M052801919	25 / 250
1½ x ½	40 x 15	M052401920	25 / 350	M052801920	25 / 150
1½ x ¾	40 x 20	M052401921	25 / 200	M052801921	25 / 150
1½ x 1	40 x 25	M052401922	25 / 350	M052801922	25 / 150
1½ x 1¼	40 x 32	M052401923	25 / 400	M052801923	25 / 150
2 x ½	50 x 15	M052401924	10 / 120	M052801924	10 / 100
2 x ¾	50 x 20	M052401925	10 / 120	M052801925	10 / 100
2 x 1	50 x 25	M052401926	10 / 100	M052801926	10 / 100
2 x 1¼	50 x 32	M052401927	10 / 120	M052801927	10 / 100
2 x 1½	50 x 40	M052401928	10 / 120	M052801928	10 / 100
2½ x 1¼	65 x 32	M052401932	5 / 25	M052801932	5 / 50
2½ x 1½	65 x 40	M052401933	5 / 50	M052801933	5 / 50
2½ x 2	65 x 50	M052401934	5 / 60	M052801934	5 / 50
3 x 1½	80 x 40	M052401939	5 / 35	M052801939	5 / 35
3 x 2	80 x 50	M052401940	5 / 35	M052801940	5 / 35
3 x 2½	80 x 65	M052401941	5 / 35	M052801941	5 / 35
4 x 2	100 x 50	M052401947	5 / 20	M052801947	5 / 20
4 x 2½	100 x 65	M052401948	5 / 10	M052801948	5 / 20
4 x 3	100 x 80	M052401949	5 / 20	M052801949	5 / 20
6 x 3	150 x 80	* 437-530	3 / --		
6 x 4	150 x 100	* 437-532	3 / --	M052801958	1 / 6
8 x 6	200 x 150	* 437-585	1 / --	M052801968	1 / 3

UNION SOC WITH EPDM O-RING SEAL

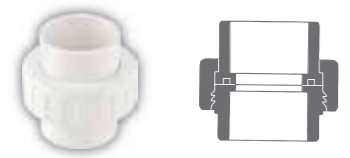

Size (in.)	Size (mm)	Part No.	Std Pkg Bag/Case
½	15	M052802601	10 / 200
¾	20	M052802602	10 / 120
1	25	M052802603	10 / 80
1¼	32	M052802604	10 / 50
1½	40	M052802605	10 / 80
2	50	M052802606	5 / 30
2½	65	* 897-025	5 / --
3	80	* 897-030	5 / --
4	100	* 897-040	5 / --
6	150	* 897-060	3 / --

CAP - SOC



Size (in.)	Size (mm)	Part No.	Std Pkg Bag/Case	Part No.	Std Pkg Bag/Case
½	15	M052404101	100 / 1200	M052804101	100 / 800
¾	20	M052404102	100 / 600	M052804102	50 / 500
1	25	M052404103	50 / 350	M052804103	50 / 300
1¼	32	M052404104	10 / 220	M052804104	10 / 150
1½	40	M052404105	10 / 270	M052804105	10 / 100
2	50	M052404106	10 / 90	M052804106	10 / 70
2½	65	M052404107	5 / 50	M052804107	5 / 40
3	80	M052404108	5 / 35	M052804108	5 / 25
4	100	M052404109	1 / 22	M052804109	1/18
6	150	* 447-060	1 / --	* 847-060	1 / --

uPVC PRESSURE FITTINGS

SCHEDULE 40 AS PER ASTM D-2466 AND SCHEDULE 80 AS PER ASTM D-2467

CAP FIPT



Size (in.)	Size (mm)	SCHEDULE 40		SCHEDULE 80	
		Part No.	Std Pkg Bag/Case	Part No.	Std Pkg Bag/Case
½	15	* 448-005	50 / --		
¾	20	* 448-007	25 / --		
1	25	* 448-010	25 / --		
1¼	32	* 448-012	10 / --		
1½	40	* 448-015	10 / --		
2	50	* 448-020	10 / --		
2½	65	* 448-025	10 / --		
3	80	* 448-030	10 / --		

BALL VALVE (ASTRAL)



Size (in.)	Size (mm)	Part No.	Std Pkg Bag/Case
½	15	T 2622-005	1/48
¾	20	T 2622-007	1/36
1	25	T 2622-010	1/16
1¼	32	T 2622-012	1/10
1½	40	T 2622-015	1/8
2	50	T 2622-020	1/6

BALL VALVE - SOC

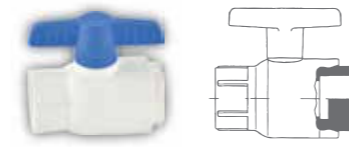

Size (in.)	Size (mm)	Part No.	Std Pkg Bag/Case
½	15	M052402701	1/80
¾	20	M052402702	1/100
1	25	M052402703	1/70
1¼	32	M052402704	1/40
1½	40	M052402705	1/30
2	50	M052402706	1/15
2½	65	* 2622-025	6 / --
3	80	* 2622-030	4 / --
4	100	* 2622-040	1 / --
6	150	* 2622-060	1 / --

uPVC PRESSURE FITTINGS

LONG RADIUS BEND 90°



Size (in.)	Size (mm)	Part No.	Std Pkg Bag/Case
½	15	F052800901	120
¾	20	F052400902	85
1	25	F052400903	50
1¼	32	F052400904	30
1½	40	F052400905	18
2	50	F052400906	12

STEP OVER BEND



Size (in.)	Size (mm)	Part No.	Std Pkg Bag/Case
½	15	A052402801	90
¾	20	A052402802	60
1	25	A052402803	30
1¼	32	F052402804	25
1½	40	F052402805	20
2	50	F052402806	10

TANK ADAPTER

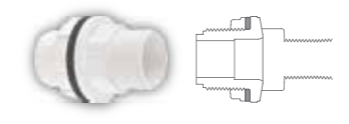

Size (in.)	Size (mm)	Part No.	Std Pkg Bag/Case
½	15	M052402501	10 / 80
¾	20	M052402502	10 / 60
1	25	M052402503	10 / 40
1¼	32	M052402504	10 / 30
1½	40	M052402505	10 / 20
2	50	M052402506	5 / 15

uPVC PRESSURE FITTINGS

TANK ADAPTOR (SOCKET TYPE)



Size (in.)	Size (mm)	Part No.	Std Pkg Bag/Case
¾	20	M0528010202	60
1	25	M0528010203	75
1¼	32	M0528010204	-
1½	40	M0528010205	-
2	50	M0528010206	-

TANK ADAPTOR (SPIGOT TYPE)



½	15	M052806501	-
¾	20	M052806502	-
1	25	M052806503	-
1¼	32	M052806504	-
1½	40	M052806505	-
2	50	M052806506	-

TANK ADAPTER (PIPE THREAD STYLE)



½	15	F052806501	10 / 80
¾	20	F052806502	10 / 60
1	25	F052806503	5 / 40
1¼	32	F052806504	6 / 18
1½	40	F052806505	4 / 12
2	50	F052806506	4 / 8

END PLUG THREADS



½	15	M014002901	300
¾	20	M014002902	200

METAL STRAP



½	15	PVC9120M	100 / 800
¾	20	PVC9340M	100 / 500
1	25	PVC9100M	100 / 400
1¼	32	PVC9105M	50 / 300
1½	40	PVC9106M	50 / 250
2	50	PVC9200M	50 / 200

VANSTONE FLANGE - SOC



½	15	M052803401	10 / 120
¾	20	M052803402	10 / 80
1	25	M052803403	10 / 60
1¼	32	M052803404	5 / 50
1½	40	M052803405	5 / 35
2	50	M052803406	5 / 25
2½	65	M052803407	1 / 15
3	80	M052803408	1 / 12
4	100	M052803409	1 / 8
6	150	M052803410	1 / 3
8	200	M052803411	1 / 1

uPVC PRESSURE FITTINGS

BLIND FLANGE



Size (in.)	Size (mm)	Part No.	Std Pkg Bag/Case
2½	65	* 853-025	5 / --
3	80	M052803108	1 / 20
4	100	M052803109	1 / 12
6	150	* 853-060	1 / --

ONE PIECE FLANGE - SOC



2½	65	* 851-025	5 / --
3	80	M052803208	1 / 12
4	100	M052803209	1 / 8
6	150	* 851-060	1 / --

VANSTONE FLANGE - SPIG



2½	65	* 856-025	5 / --
3	80	M052803308	1 / 10
4	100	M052803309	1 / 6
6	150	* 856-060	1 / --

FLANGE RING



2½	65	M052804207	1 / --
3	80	M052804208	1 / --
4	100	M052804209	1 / --
6	150	M052804210	1 / --
8	200	M052804211	1 / --

FLANGE HUB CL 150



2½	65	M052803607	1 / --
3	80	M052803608	1 / --
4	100	M052803609	1 / --
6	150	M052803610	1 / --
8	200	M052803611	1 / --

FLANGE HUB - SPIGOT



3	80	M052803708	1 / --
4	100	M052803709	1 / --



UPVC PRESSURE PIPES

uPVC PRESSURE PIPES SCHEDULE 40 & SCHEDULE 80 AS PER ASTM D-1785

Schedule 40		Schedule 80			
Size (In.)	Size (mm)	Part No.	Std. Pkg Bag/Case 3MTR	Part No.	Std. Pkg Bag/Case 3MTR
½	15	M051400301	50	M051800301	50
¾	20	M051400302	30	M051800302	30
1	25	M051400303	20	M051800303	20
1¼	32	M051400304	15	M051800304	15
1½	40	M051400305	10	M051800305	10
2	50	M051400306	8	M051800306	8
2½	65	M051400307	5	M051800307	5
3	80	M051400308	3	M051800308	3
4	100	M051400309	2	M051800309	2
6	150	M051400310	1	M051800310	1
8	200	M051400311	1	M051800311	1
10	250	M051400312	1	M051800312	1
12	300	M051400313	1	M051800313	1

uPVC SOLVENT CEMENT & PRIMER



AS PER ASTM D-2564

MEDIUM BODIED PVC 705	Part No.	Std. Pkg. Case
22 ml	M053010101	48
44 ml	M053010102	24
50 ml	M053010103	48
118 ml	M053010104	24
237 ml	M053010105	24
473 ml	M053010106	12
946 ml	M053010107	12

AS PER ASTM D-2564

MEDIUM BODIED PVC 705	Part No.	Std. Pkg. Case
473 ml	M053030404	12
946 ml	M053030505	12

AS PER ASTM D-2564

MEDIUM BODIED PVC 705	Part No.	Std. Pkg. Case
473 ml	M033050101	12
946 ml	M033050201	12

INSTALLATION PROCEDURE



CUT PIPE

- Cut pipe square. As joints are sealed at the base of the fitting socket. An angled cut may result in joint failure.
- Acceptable tools include miter saw, mechanical cut off saw or wheel cutter. Wheel type cutters must employ a blade designed for plastics.



REMOVE BURR & BEVEL

- Remove all burr from inside and outside of pipe with a knife-edge, file or deburring tool Chamfer (bevel) the end of the pipe 100 -150.

CLEAN

- Remove surface dirt, grease or moisture with a clean dry cloth.

DRY FIT

- With light pressure, pipe should go one third to one half of the way into the fitting socket Pipes and Fittings that are too tight or too loose should not be used.



APPLICATOR

- Use an applicator that is one half the pipe diameter.
- Too large an applicator will force excessive cement in to the inside of small diameter fittings. Too small an applicator will not apply sufficient cement to large diameter systems.



CEMENT

- Apply a full even layer of cement to the outside of a pipe and medium layer of cement to the inside of a fitting.

JOIN PIPE & FITTING

- Assemble pipe and fitting socket till it contacts socket bottom. Give pipe a quarter turn. Hold pipe and fitting together until the pipe does not back out.
- Remove excessive cement from the exterior. A properly made joint will show a continuous bead of cement around the perimeter.
- Observe all safety precautions.
- Systems should be installed in a good and workmanlike manner consistent with normal industry standards and in conformance with all local plumbing, fire and building code requirements. Failure to follow proper installation practices, procedures or techniques can result in system failure, property damage or personal injury.
- Pipes and fittings should be used for their intended purpose as defined by local plumbing and building codes and the applicable ASTM standards.
- Follow manufacturers instructions for all related products.



uPVC cement for SCH 40 and interference fit			
Pipe Size (In.) (mm)	Cement Type	Min. Vis. (cP)	IPS-Weld On
½-2	Medium	500	705
15-50 mm	Bodied		
2½-12	Heavy	1600	717
65-300 mm	Bodied		

uPVC cement for SCH 80 and interference fit			
Pipe Size (In.) (mm)	Cement Type	Min. Vis. (cP)	IPS-Weld On
	Medium	500	705
15-32 mm	Bodied		
	Heavy	1600	717
40-300 mm	Bodied		

EXPANSION AND CONTRACTION OF uPVC PIPE

CARRYING CAPACITY AND FRICTION LOSS FOR SCHEDULE 80 THERMOPLASTIC PIPE

uPVC pipes, like other piping materials, undergo length changes as a result of temperature variations above and below the installation temperature. They expand and contract 4.5 to 5 times more than steel or iron pipe. The extent of the expansion - contraction depends upon the coefficient of linear expansion of piping material. The length of pipe between directional changes, and the temperature differential.

The coefficient of thermal expansion (Y)

for uPVC is 3.1×10^{-5} in./in./°F.

The amount of expansion or contraction can be calculated using the following formula :

$$\Delta L = Y (T1-T2) \times L$$

ΔL = Dimensional change due to thermal expansion or contraction (in).

Y = Expansion coefficient (in./in./°F)

(T1-T2) = Temperature differential between the installation temperature and the maximum or minimum system temperature, whichever provides the greatest differential (°F).

L = Length of pipe run between changes in direction (ft)

There are several ways to compensate for expansion and contraction. The most common methods are :

1. Expansion loops which consist of pipe and 90° elbows
2. Piston type expansion joints*
3. Flexible bends*
4. Bellows and rubber expansion joints*

* The manufacturers of these devices should be contacted to determine the suitability of their products for the specific application.

Expansion loops are a simple and convenient way to compensate for expansion and contraction when there is sufficient space for the loop in the piping system. A typical expansion loop design is shown below.

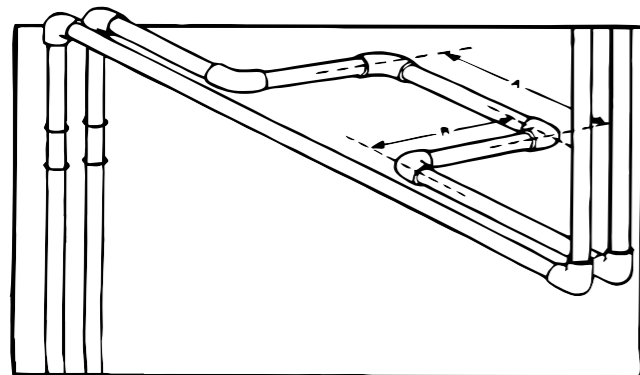

The length of leg "R" can be determined by using the following formula to ensure that it is long enough to absorb the expansion and contraction movement without damage. The length of leg "A" should be 1/2 the length of leg "R"

$$R = 1.44 D \Delta L$$

R = Expansion loop leg length (ft)

D = Nominal outside diameter of pipe (in).

(See table below.)

ΔL = Dimensional change due to thermal expansion or contraction (in).

When installing the expansion loop, no rigid or restraining supports should be placed within the leg lengths of the loop. The loop should be installed as closely as possible to the mid-point between anchors. Piping support guides should restrict lateral movement and direct axial movement into the loop. Lastly, the pipe and fittings should be solvent cemented together, rather than using threaded connections.

Compensation for expansion and contraction in underground application is normally achieved by snaking the pipe in the trench. Proper trenching and burial procedures must be followed to protect the piping system.

The table below shows recommended off sets and loop lengths for piping up to 2½" nominal size.

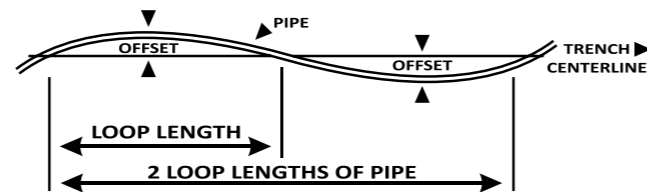

Max. Temp. Variation °F, Between Installation										
	10°	20°	30°	40°	50°	60°	70°	80°	90°	100°
Loop Length in Feet	Loop Offset in Inches									
20	3.0	3.5	4.5	5.0	6.0	6.5	7.0	7.0	8.0	8.0
50	7.0	9.0	11.0	13.0	14.0	15.5	17.0	18.0	19.0	20.0
100	13.0	18.0	22.0	26.0	29.0	31.5	35.0	37.0	40.0	42.0

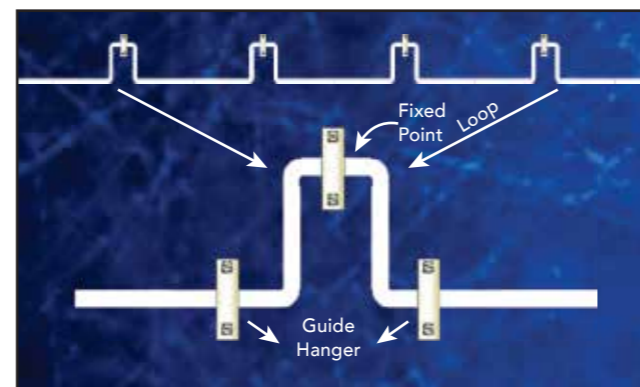



UNDERGROUND INSTALLATION



uPVC pipes and fittings can be installed underground, Since these piping systems are flexible systems, proper attention should be given to burial conditions. The stiffness of the piping system is affected by sidewall support, soil compaction, and the condition of the trench, Trench bottoms should be smooth and regular in either undisturbed soil or a layer of compacted backfill. Pipe must lie evenly on this surface throughout the entire length of its barrel, Excavation, bedding and backfill should be in accordance with the provision of the local Plumbing Code having jurisdiction

TRENCHING

The following trenching and burial procedures should be used to protect the piping system.

1. The trench should be excavated to ensure the sides will be stable under all working conditions. The trench should be wide enough to provide adequate room for the following :
 - A. Jointing the pipe in the trench.
 - B. Snaking the pipe from side or side to compensate for expansion and contraction.
 - C. Filling and compacting the side fills.The space between the pipe and trench wall must be wider than the compaction equipment used in the compaction of the backfill. Minimum width shall not be less than the greater of either the pipe outside diameter plus 16 inches of the pipe outside diameter times 1.25 plus 12 inches. Trench width may be different if approved by the design engineer.
2. The trench bottom should be smooth, free of rocks and debris, continuous, and provide uniform support. If ledge rock, hardpan or large boulders are encountered, the trench bottom should be padded with bedding of compacted granular material to a thickness of at least 4 inches. Foundation bedding should be installed as required by the engineer.
3. Trench depth is determined by the pipe's service requirements. Plastic pipe should always be installed at least below the frost level. The minimum cover for lines subject to heavy overhead traffic is 24 inches.
4. A smooth, trench bottom is necessary to support the pipe over its entire length on firm stable material. Blocking should be used charge pipe grade or to intermittently support pipe over low sections in the trench.

BEDDING AND BACKFILLING

1. Even though sub-soil conditions vary widely from place to place, the pipe backfill should be stable and provide protection for the pipe.
2. The pipe should be surrounded with a granular material which is easily worked around the sides of the pipe Backfilling should be performed in layer of 6 inch with each layer being sufficiently compacted to 85% to 95% compaction.
3. A mechanical tamper is recommended for compacting sand and gravel backfill which contain a significant proportion of fine grained material, such as silt and clay. If a tamper is not available, compacting should be done by hand.
4. The trench should be completely filled. The back fill should be placed and spread in fairly uniform layers to prevent any unfilled spaces or voids. Large rocks, stones, frozen clods, or other large debris should be removed. Heavy tampers or rolling equipment should only be used to consolidate only the final backfill.

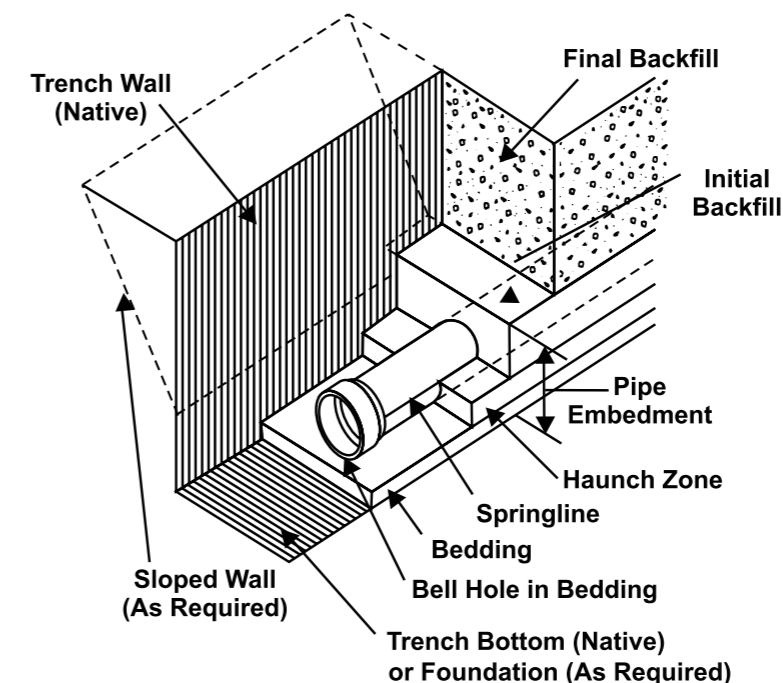

FIG. 1 Installation Terminology



HANDLING AND STORAGE

HANDLING

The pipe should be handled with reasonable care. Because thermoplastic pipe is much lighter in weight than metal pipe. There is sometimes a tendency to throw it around. This should be avoided. The pipe should never be dragged or pushed from a truck bed. Pallets for pipe should be removed with a fork lift. Loose pipe can be rolled down timbers, as long as the pieces do not fall on each other or on any hard or uneven surface. In all cases, severe contact with any sharp objects (rocks, angle irons, forks on forklifts, etc.) should be avoided.

STORAGE

If possible, pipe should be stored inside. When this is not possible, the pipe should be stored on level ground which is dry and free from sharp objects. If different schedules of pipes are stacked together, the pipe with the thickest walls should be at the bottom.

The pipe should be protected from the sun and be in an area with proper ventilation. This will lessen the effects of ultraviolet rays and help prevent heat built-up.

If the pipe is stored in racks, it should be continuously supported along its length. If this is not possible, the spacing of the supports should not exceed three feet (3').

When storage temperatures are below 0°C (32°F), extra care should be taken when handling the pipe. This will help prevent any problems which could be caused by the slightly lower impact strength of uPVC pipe at temperature below freezing.

NOT FOR USE WITH COMPRESSED AIR OR GASES

ASTRAL POLY TECHNIK LTD. DOES NOT RECOMMEND the use of thermoplastic piping products for systems to transport or store compressed air or gases, or the testing of thermoplastic piping systems with compressed air or gases in above as well as below ground locations, The use of ASTRAL Aquarius product in compressed air or gas systems automatically void any warranty for such products and its use against our recommendation is entirely the responsibility and liability of the installer.

WARNING : Do Not Use Compressed Air Or Gas To Test any PVC Thermoplastic Piping Product Or System, And Do Not Use Devices Propelled By Compressed Air Or Gas To Clear Systems. These Practices May Result In Explosive Fragmentation Of System Piping Components Causing Serious Or Fatal Bodily Injury.

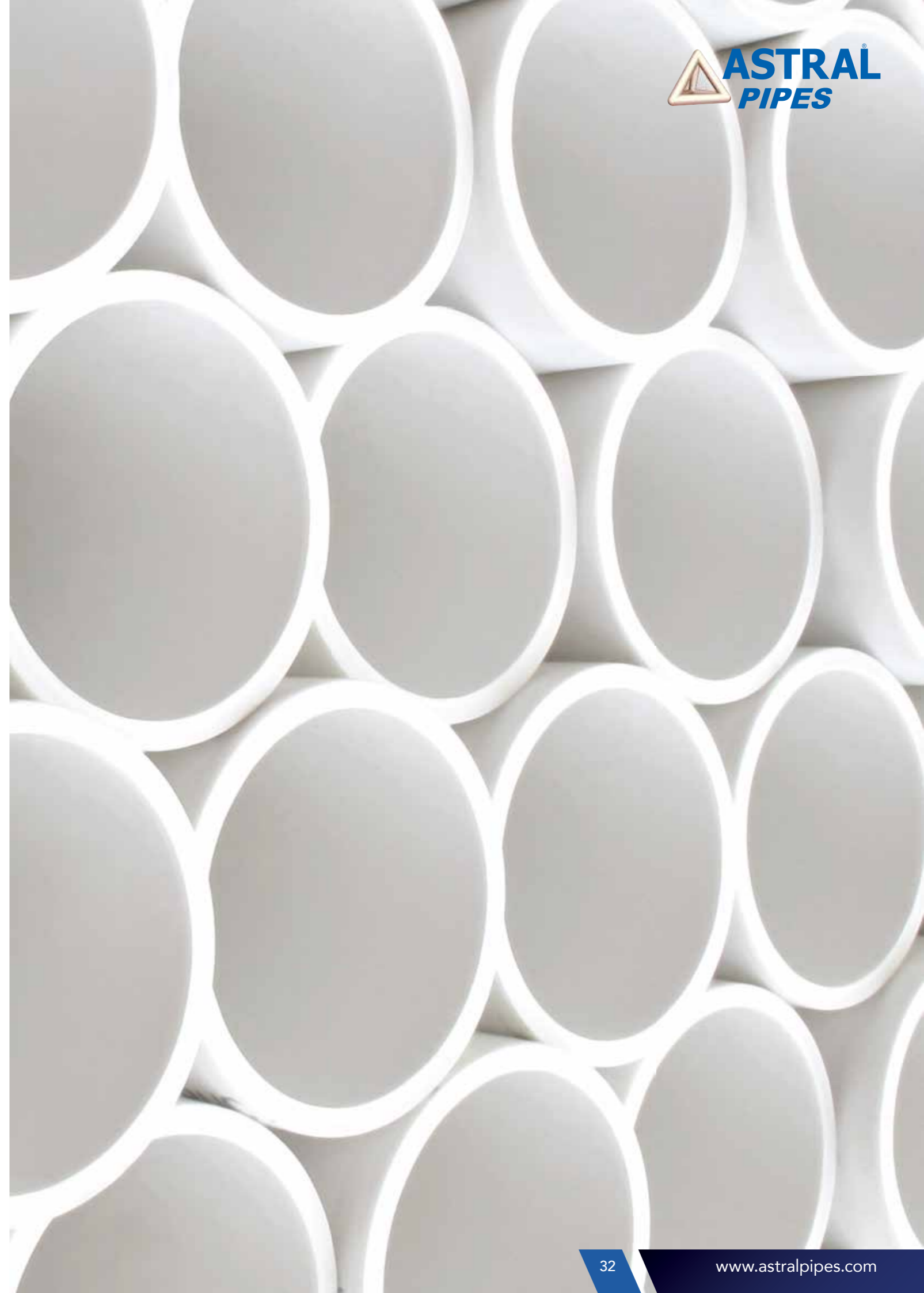
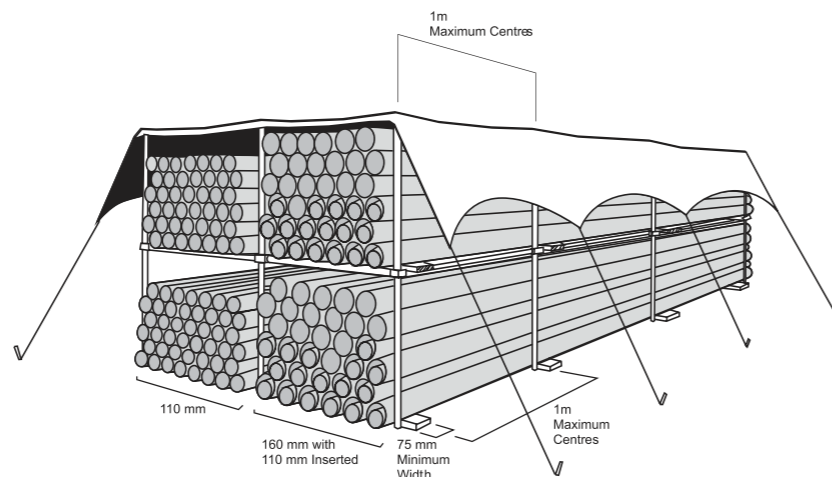



FREQUENTLY ASKED QUESTIONS ABOUT ASTRAL AQUARIUS[®]

01 / Why Lead Free ?

Lead is a metal with no known biological benefit to humans. Too much lead can damage various systems of the body including the nervous and reproductive systems and the kidneys, and it can cause high blood pressure and anemia. Lead accumulates in the bones and lead poisoning may be diagnosed from a blue line around the gums. Lead is especially harmful to the developing brains of fetuses and young children and to pregnant women. Lead interferes with the metabolism of calcium and Vitamins D. High blood lead levels in children can cause consequences which maybe irreversible including learning disabilities, behavioral problems, and mental retardation. At very high levels, lead can cause convulsions, coma and death. Lead can be dissolved in water when lead pipes are used for transportation of water. So use of such pipes may be harmful to human being. Hence lead free plumbing system is most favoured for potable water transportation.

02 / What is the expected life of a ASTRAL Aquarius System?

ASTRAL Aquarius uPVC system design & standards incorporate significant engineering safety factors which should translate to a long service life ASTRAL Aquarius System have a design service life span of 50 years. ASTRAL Aquarius System is not susceptible to corrosion, scale build up or electrolysis in areas where water, solid and / or atmospheric conditions are aggressive. ASTRAL firmly believes that the system will provide a service life as long or longer than alternative materials in the market.

03 / Will ASTRAL Aquarius System save me money ?

Yes, As a professional, you will quickly realize that uPVC can be installed at least 25% more quickly than metal systems. Financial savings are also realized with regard to lower tool costs and insurance advantage. Even considering the frequent rise and fall of the metal price structure, uPVC offers a continuing materials cost advantage, as much as a full 50-60% material savings today.

04 / Will ASTRAL Aquarius System offer a financial advantage to owners in terms of utilities expense?

Yes, the thermal conductivity of a metal system is 2500 times that of a uPVC system. The improved insulating characteristics associated with uPVC can generate long term saving for energy conscious homeowner or tenant. ASTRAL Aquarius will hold the temperature of water for a much longer period of time than metal tubing.

05 / Must I use plastic insulators wherever uPVC passes through a stud ?

Technically, no such provision need be made when passing through wood stud. When passing through metal studs some form of protection must be used to protect the pipe from abrasion and to prevent noise. This protection may come from plastic insulation rubber grommets, pipe insulation or similar.

06 / Should specific type of Primers and solvent cements be used on uPVC system?

ASTRAL always recommends use of solvent cement which is specifically manufactured to meet the requirements of ASTM D 2564. All purpose cements should not be utilized. Primers manufactured for uPVC pipe is acceptable. For more details, refer installation procedure of this manual.

07 / I have been told that uPVC tubing ends may split during installation. Why should this occur? How can these cracks be prevented?

Most cracks are initiated by rough handling. This handling can occur during transportation, while being inventoried at the wholesaler, or while at the job sight. Also, Fine cracks can be caused by cutting the pipe with dull or damaged ratchet cutters. The vast majority cracks occur during colder weather months when temperatures are below 10°C, uPVC like most other plastics such as PP, PEX, CPVC, may become somewhat brittle and should be handled more carefully.

To reduce problems resulting from cracked product, several measures can be initiated : (A) Educate your installers. Make them aware of the potential problems and instruct them to handle uPVC in a appropriate way. (B) Use a saw or a circular tubing cutter with a plastic tubing blade to cut your pipe to length. (C) Inspect pipe ends thoroughly prior to making a joint. Should a crack be evident, cut off any split portion before proceeding. (D) During cold weather, gripping the tubing highly around the area to be cut for about 10 seconds prior to making the cut will warm the tubing and reduce possible problems.

08 / What about health, safety & fire toxicity issues?

Tests performed at respected universities and independent laboratories confirm that uPVC is superior to metal systems in terms of water quality effects and "no more toxic than wood" in fire. ASTRAL Aquarius uPVC system is manufactured from a compound which is lead free and hence most favoured system in terms of health and safety. LOI of uPVC is 45, which means uPVC is not really burnable in atmosphere. Once the burning source is removed, it stops burning.

09 / Is ASTRAL Aquarius System resistant to U.V. exposure ?

- Effect of U.V. On polymers "U.V. acts as a strong catalyst for the oxidations process which breaks down the polymer chains, leading weakness in the pipes & fittings and to loss of hydrostatic strength. "Above effect is very much possible with materials like PP & PE. But for uPVC main process is dehydrochlorination and not oxidation. This dehydrochlorination does not break down the polymer chains to any significant extent after outdoor exposure, being mainly limited to a surface discoloration effect only.

There is a loss of Impact resistance due to impact modifiers losing efficiency.

This may even result in increased modulus.

There is no significant loss in stress bearing capacity Impact resistance mainly an Installation issue (before any U.V. exposure)

Still if a portion of the piping system will be left exposed to U.V.light, a standard grade of exterior, latex paint (water base) will protect the pipe adequately.

10 / Is it possible to use ASTRAL Aquarius System at temperature around 10-15°C?

Practically, Yes. It is very much possible to use ASTRAL Aquarius at a temperature around 10 - 15 °C. Normal temperature range of uPVC compound material is 23°C to 60 °C. As temperature decrease beyond 23°C, uPVC becomes brittle like any other thermoplastic material. So its impact properties decrease as temperature decrease but there is no reduction in hydrostatic strength of material at lower temperatures so it can be used at lower temperatures but very sound engineering design considerations required at a such low temperatures to eliminate water hammers & impact issues.

11 / What about the noise emissions compare to metallic system? The tendency of sound is to travel in the material with fastest possible velocity.

This means in metal system, the sound travels in metal because the velocity of sound in metal is higher than that of in water and create noise emissions. While in uPVC system, noise will travel in water because the velocity of sound in water is higher than that of in uPVC. So uPVC systems are as quiet as physically possible.

12 / What about scale build up?

Scale built up is a function of the roughness of the pipe, as measured by the Hazen - Williams "C" factor, used in the Hazen Williams formula for calculating friction head losses in piping system.

Higher value for C - Less friction,

- Less head loss.

with metal systems, once corrosion starts "C" factor will greatly reduce which result in head loss and scale built up. With ASTRAL Aquarius uPVC, there is no corrosion and hence scale built up is inhibited.

13 / Is it possible to connect IPS system with CTS system?

IPS (Iron Pipe Size) & CTS (Copper Tube Size) are most widely used systems in plumbing market. Therefore changeability of one to another is very much important. ASTRAL has understood this requirement of market and hence developed special transition fittings. These fittings will connect the IPS System (SCH 40 & SCH 80) to CTS system (SDR 11 & SDR 13.5). These transition fittings are joined with one step solvent cement, which gives customer a very fast, efficient & simple solution to join both systems. Available sizes are from 15mm (1/2") to 50mm (2").

